



# Product-Overview Excerpt

## 2023

- CONSUMER ELECTRONIC • MOBILE CHARGER • OUTDOOR & SPORT
- SMART HOME / SECURITY • HEALTH, WEATHER & WATCHES • IT
- IT-, TK-ACCESSORIES • TV-MOUNTS & ACCESSORIES
- OTHER ACCESSORIES • PROMOTIONAL ITEMS • TOYS • MISCELLANEOUS

### **New-Tech-Products Handels GmbH**

Nersinger Straße 14-16 • 89275 Elchingen • +49 7308 / 811 00 0 • Fax: +49 7308 / 811 00 19  
e-mail: [info@new-tech-products.com](mailto:info@new-tech-products.com) • [www.new-tech-products.com](http://www.new-tech-products.com)

[ 2023\_v01.5 01.2023 ]

# INDEX

- Consumer Electronic
- Mobile Charger
- Outdoor & Sport
- Smart Home / Security
- Energy
- Health, Weather & Watches
- IT & IT-Accessories
- TK-Accessories
- TV-Mounts & Accessories
- Other Accessories
- Promotional Items
- Toys
- Miscellaneous

CONSUMER ELECTRONIC

# Aiwa

## Turntables

- 3 speeds Turntable
- Ceramic cartridge with ruby stylus.
- Built-in full-range speakers
- USB / SD playback
- USB / SD / USB encoding
- Bluetooth in
- FM radio

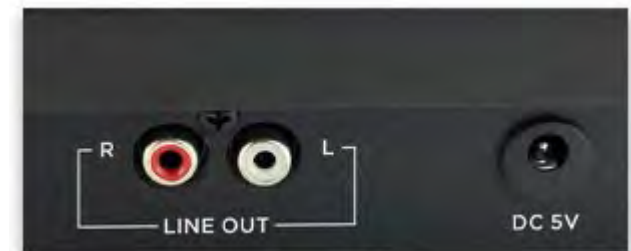

## RMS Stereo Amplifier with Bluetooth and DAB+/FM

- Output power: 200W RMS



AMR-200DAB



# August

[www.augustint.com](http://www.augustint.com)

## NOISE CANCELLING - BLUETOOTH EARPHONES



### August EP765

- Chipsatz: QCC3005+ADI1777
- Bluetooth Version: v5.0
- Frequenz: 2.4GHz – 2.48GHz
- Bluetooth Profile: HSP/HFP/A2DP/AVRCP/ APTX/APTXLL/AAC/SBC
- Reichweite: Bis zu 15m
- Ladespannung: 5V
- Akku: Lithium Polymer Akku mit 580 mAh
- Ladezeit: 2-3 Stunden
- Sprechzeit: 23 Stunden
- Wiedergabezeit ohne ANC: Bis zu 20 Stunden
- Wiedergabezeit mit ANC: Bis zu 15 Stunden
- Lautsprecher: 40mm
- Rauschunterdrückung Frequenzbreite 80-20Khz

# August

[www.augustint.com](http://www.augustint.com)

## BLUETOOTH EARPHONES WITH APT-X, NFC ...



- Perfekte Klangqualität ganz ohne Kabel
- Verbinden Sie den EP650CB mit kompatiblen Bluetooth-Mobilgeräten wie Laptops, Handys oder Smartphones und genießen Sie im Haus oder im Freien bis zu 10 Meter kabellose Freiheit bei der Audiowiedergabe
- aptX Technologie, auch kabellos nahezu in CD Qualität Musik genießen
- NFC, Kopplung per Berührung
- Eingebautes Mikrofon, mit der Freisprechfunktion bleiben Sie immer verbunden
- Lautstärkeregelung, Titelsteuerung und Anrufannahme/Mikrofonaktivierung für einfache Musik- und Anrufwiedergabe
- Integrierter Akku
- mehr als 10 Stunden Musikgenuss!
- USB Audio sowie 3,5mm Standard Audio Eingang
- klassische Wiedergabe über Kabel möglich, wenn kein Bluetooth verfügbar sein sollte oder der Akku des Kopfhörers leer ist
- Inklusive Etui für komfortablen Transport



# August & Platinet & TnB

[www.augustint.com](http://www.augustint.com)

## BT-TRANSMITTER & FM-TRANSMITTER

<p><b>August MR230</b> Bluetooth Audio Receiver</p>  <p>The August MR230 is a black rectangular Bluetooth audio receiver. It features a DC In port, an Audio Out port, and a Speaker port. A diagram shows it connected to an iPhone, a computer, and an MP4 player, with audio being sent to a speaker system.</p>	<p><b>August MR250</b> Bluetooth Audio Transmitter</p>  <p>The August MR250 is a black rectangular Bluetooth audio transmitter. It has an FM/MP3/MP4 input and a 3.5mm Audio In port. A diagram shows it connected to a smartphone and a pair of headphones, with audio being transmitted to a car stereo.</p>	<p><b>August MR260</b> 2-in-1 Bluetooth Stereo Audio Transmitter/Receiver</p>  <p>The August MR260 is a black rectangular 2-in-1 Bluetooth stereo audio transmitter/receiver. A diagram shows it connected to a smartphone and a car stereo, with audio being transmitted to the car stereo.</p>
<p><b>August MR270B-HD</b> Bluetooth v5.0 Audio Dual Transmitter</p>  <p>The August MR270B-HD is a black rectangular Bluetooth v5.0 audio dual transmitter. A diagram shows it connected to a computer, a TV, and a printer, with audio being transmitted to two pairs of headphones.</p>	<p><b>TnB FMCT07</b> Bluetooth FM-Transmitter &amp; Hands free kit</p>  <p>The TnB FMCT07 is a silver and black car-mounted Bluetooth FM-transmitter and hands-free kit. It features a digital display, a microphone, and two USB ports.</p>	
<p><b>TnB FMCT03BT</b> Bluetooth FM-Transmitter</p>  <p>The TnB FMCT03BT is a circular black Bluetooth FM-transmitter with a red digital display showing '107.7'. It includes a USB cable and a car charger.</p>	<p><b>TnB FMCT03JACK</b> FM-Transmitter</p>  <p>The TnB FMCT03JACK is a circular black FM-transmitter with a red digital display showing '107.7'. It includes a USB cable and a car charger.</p>	 <p>A second view of the TnB FMCT07 Bluetooth FM-transmitter and hands-free kit, showing its car-mounted design and control buttons.</p>



# Clocky

[www.clocky.com](http://www.clocky.com)

## ROLLING ALARM CLOCK



Almond



Gold



Red



Aqua



Green



Black



Chrome



Raspberry



# Cowon

[www.cowonglobal.com](http://www.cowonglobal.com)

## PLENUE D3 – HIGH-END AUDIO PLAYER

High Definition Sound  
Small changes make it difference

Minimal design in your hands.  
Keep it strong sound performance.  
Convenience of volume wheel allows you to use it simple.  
Add Bluetooth function for wireless comfort.

Sense the differences of PlenuE D3. PlenuE

D3 is very small and light.  
You can make your own sound stage with PlenuE D3 in anytime and anywhere you go.

It makes your day more energetic and pleasant.



**COWON**  
**PLENUE D3**

A volume control wheel could make an adjustment related to music listening and user could enjoy the convenience comparing to previous model.

Bluetooth function is installed.

A Type-C USB port for greater convenience while maintaining a small port size. It can be used a universal smart phone port to allow charging with modern smartphone charging cables.

Higher quality of Audio system make users experience pure and clear sound as a crystal.

File Formats	DSD(DFF, DSF, SACD-ISO) / FLAC / WAV / AIFF / ALAC / APE / MP3 / WMA / OGG / DCF
Audio Codecs	DSD : ~5.64MHz (DSD64, DSD128) : DSD stereo/mono (DFF, DSF, SACD-ISO) does not support Bluetooth, JetEffect, or playback speed control. FLAC, WAV, AIFF, ALAC : ~24bit/192kHz - 32bit WAV, WAV Tag Supporting MP3 : MPEG 1/2/2.5 Layer 3, ~320kbps WMA : ~320kbps, ~48kHz APE : Fast, normal, and high compression rates (~16bit/48kHz) OGG : ~Q10, ~44.1kHz
Bluetooth	3.0 (Supported profiles: A2DP, AVRCP / Supported codecs : SBC, aptX)
Track Information	CUE sheet, SACD-ISO (2ch)
Lyrics	LRC, LDB, Lyrics3, ID3 Tag Lyrics
Playback Speed	50-150%, Supports Pitch Correction <sup>1)</sup> <small>1) JetEffect will not be supported when adjusting the playback speed, and you may experience difficulties adjusting playback speed for some music.</small>
JetEffect 5	48 Presets (44 Presets + 4 User Presets) - EQ : 5 Band Equalizer (EQ Filter) - BBE+ : BBE, Mach3Bass, 3D Surround, MP Enhance - Special Effect : Reverb (9 modes)

# Cowon

[www.cowonglobal.com](http://www.cowonglobal.com)

## PLENUE R2 - EXTREME HI-FI SOUND



Highly Advanced Dual-DAC Design and Tuning

SNR 136dB, THD+N 0.0004%

Balanced Out 4.0Vrms

Music Playback 20 hours

Equipped with a Proprietary CPLD 32bit / 384kHz

Native DSD256

aptX JetEffect Bluetooth

AI Audio

USB-C



### High Quality Bluetooth Audio Codec Qualcomm® aptX™ audio

The PLENUE R2 supports aptX, a high-quality audio codec that provides higher compression efficiency and superior sound quality compared to conventional SBC codec Bluetooth transmission. You can now enjoy PLENUE R2 through any earphones, headphones, or speakers that support Bluetooth, and the application of JetEffect 7's powerful acoustic field via Bluetooth output means you can savor rich sound quality with greater variety.

### Professional Sound Control, Now via Bluetooth JetEffect Bluetooth

Unlike typical Bluetooth products, the PLENUE R2 features JetEffect Bluetooth, which enables DSP effects via Bluetooth. Open up a new world of possibilities with a Bluetooth receiver with COWON's exclusive JetEffect technology.

### Phone Call Alerts for Greater Convenience

Connect the PLENUE R2 to your smartphone via Bluetooth to receive alerts for incoming phone calls. Never miss another call while listening to your favorite music.

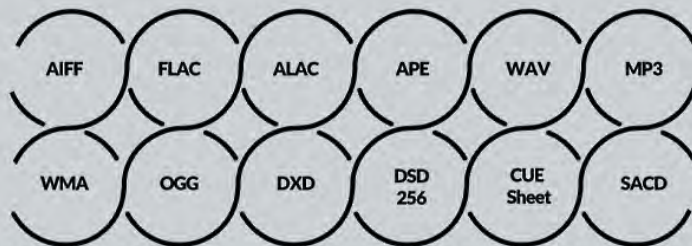

### Extensive Codec Support from 32bit/384kHz HD Sound to DXD and DSD256

The PLENUE R2 supports a variety of audio formats, from 32bit/384kHz lossless/uncompressed AIFF to lossless/compressed formats such as FLAC, ALAC, and APE, as well as other popular formats including WAV, MP3, WMA, and OGG. Also, the device supports DXD(352.8/384kHz) and Native DSD256(11.2MHz) format to offer wide range of high quality sound formats.

### 32bit, 384kHz Ultra-High Resolution The Next-generation Premium DAC

The PLENUE R2 features a high-end DAC that supports 32bit, 384kHz for smooth playback of most existing high-quality audio files. As the premier DAC in the MasterHIFI™ line of Cirrus Logic hi-fi audio products, the CS43131 DAC offers an unparalleled level of performance. CS43131 is a high-performance DAC with a built-in high-resolution headphone amplifier. The next-generation premium DAC merely sips battery power while delivering the best audio output.

### Dual Ultra-High-Quality DACs Highly Advanced Dual-DAC Design and Tuning

The PLENUE R2 is equipped with two top-of-the-line CS43131 DACs and features an advanced dual-DAC design and tuning to bring you one step closer to analog sound. The digital input signal is converted by each discrete DAC, providing listeners with perfect sound as close to the original recording with zero noise.

# Cowon

[www.cowonglobal.com](http://www.cowonglobal.com)

## HIGH-END TWS EARBUDS

THE ESSENCE OF SOUND  
**COWON**

*Gala*  
PLENUE ear

**HYBRID ANC**  
Hybrid ANC eliminating ALL NOISES inside and out  
For the best-possible noise cancelling experience

FEEDBACK MIC      FEEDFORWARD MIC



**Siri, Google Assistant**  
A simple touch allows you to activate Siri or Google Assistant

• Touch the sensor for 2 seconds to launch the voice recognition feature on your smartphone or tablet.

**Easy touch control**

Just a single touch to listen to music, take calls, turn ANC on/off and to activate digital voice assistant

Hybrid ANC	Transparency Mode	7 hrs. playback (ANC mode)
Bluetooth V 5.2	10mm Dynamic driver	Haptic Design
Wireless Charging	In-ear Detection Sensor	Voice Commands

# Denver

Audio, BT-SPEAKER....



# Difrnce

[www.difrnce.nl](http://www.difrnce.nl)

MP3 / MP4 / AUDIO ACCESSORIES



# Energizer

## BT-Speaker

**Energizer**  
**MAX POWER SOUND**

**+5 Hrs Playtime\***  
\*Based on 50% Volume

**HD Sound Quality**  
Premium sound and music transmit up to 10M.

**Handsfree Audio**  
Built-in microphone allows you to answer calls or hold conference calls.

**Bluetooth Speaker with Power Bank BTS061**



**Handsfree Audio**  
Built-in microphone allows you to answer calls or hold conference call when using the speaker.

**Power Bank**  
Extra power for your device.

**Universal Compatibility**  
Works with Bluetooth connectivity, micro SD card, and USB drive.

**FM Mode**  
Enjoy high quality FM radio with a simple switch.

**Rugged Design**  
Soft touch finish to prevent scratches and provide good grip.

**BTS061**



**Energizer**  
**MAX POWER SOUND**

**+5 Hrs Playtime\***  
\*Based on 50% Volume

**HD Sound Quality**  
Premium sound and music transmit up to 10M.

**Handsfree Audio**  
Built-in microphone allows you to answer calls or hold conference calls.

**Bluetooth Speaker with Power Bank BTS102**



**Handsfree Audio**  
Built-in microphone allows you to answer calls or hold conference call when using the speaker.

**Power Bank**  
Extra power for your device.

**Universal Compatibility**  
Works with Bluetooth connectivity, micro SD card, USB drive & AUX.

**FM Mode**  
Enjoy high quality FM radio with a simple switch.

**Rugged Design**  
Soft touch finish to prevent scratches and provide good grip.

**LED Music Lights**  
Multicolor LED lights for more party vibes.

**BLACK**

**GRAY**

**BTS102**



# ESTAR

[www.estar.eu](http://www.estar.eu)

## Kid Tablets



**HERO**  
TABLETS SERIES BY **estar**

HERO SERIES FEATURES A 7" TABLET, THE PERFECT SIZE AND FUNCTION FOR YOUNGER KIDS. LIGHT, PORTABLE AND EASY TO HOLD, HERO TABLETS COME IN A COLOURFUL CASE FEATURING FAMOUS HEROES, SUCH AS BATMAN OR HARRY POTTER, TO APPEAL TO BOTH KIDS AND ADULTS.

**HERO**  
TABLET SERIES

WITH A BUILT-IN 16GB MEMORY, HERO TABLETS PROVIDE OPTIMAL PERFORMANCE FOR PLAYING GAMES, WATCHING VIDEOS AND USING APPLICATIONS. THE TABLET COMES WITH A HIGH QUALITY SOFT SILICONE CASE, PROVIDING EXTRA PROTECTION, ALONG WITH 10+ PRE-INSTALLED THEMED WALLPAPERS.

7" Screen Size  

2 GB 

HERO TABLETS ARE USED WITH GOOGLE PLAY ACCOUNTS, GIVING PARENTS TOTAL CONTROL OF WHAT APPLICATIONS THEIR CHILDREN ARE INSTALLING AND USING.

NOWADAYS IT IS BEST SOLUTION FOR DISTANCE SCHOOLING OR ONLINE LEARNING.

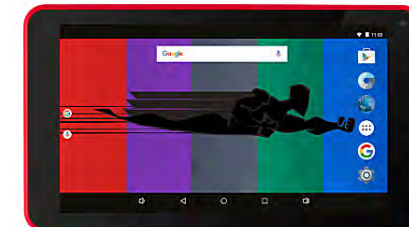

# GPO

[www.gporetro.com](http://www.gporetro.com)

## VINTAGE PORTABLE MUSIC SYSTEM



# BROOKLYN

**DAB+ • FM-Radio • CD • USB • Bluetooth • Recording**

The GPO Brooklyn is a fully portable music system, which takes the 80s Boom Box and plugs it into the 21st century. Two 40-watt speakers give your music the volume it deserves, and should you wish to have more you can add external speakers as well. Control the Volume, Balance, Bass and Treble.



# GPO

[www.gporetro.com](http://www.gporetro.com)

## VINTAGE CONSUMER ELECTRONIC



## Earphones

**Lenovo HT30** Waterproof Stereo Sound Dual Microphone Headset with Magnetic Charging Case, Built-in Microphone in each Earbud, Stereo Hand-Free Calls, Ergonomical Design, Comfortable to Wear

**TWS EARBUDS**

**Snug and Comfortable fit**  
Enjoy your music comfortably all day.



- 20 hours Music playback time
- 200+ hours Extra long standby



- **Lenovo EQ** Tech with Extra bass
- **IPX5 Sweet** Water-resistant



**LENOVO EQ**  
**TWS HT20**

LENOVO EQ, Support Extra Bass mode & Standard Mode  
25 hours Playing time with 200H standby time  
Excellent Compatibility with Bluetooth 5.0  
IPX5 Sweet & Water-resistant

**One-Step Pairing**

Take out the earbuds from the charging case they will automatically power on/select "T10" on your phone to pair.



**Superior Sound Quality**

Powerful bass, clear vocals, and crisp high tones.



**IPX5 Sweat & Water-resistant**



**Lenovo HT10**

Qualcomm aptX  
Lenovo EQ Tech with Extra bass

8X(48) hours Playing time  
Intelligent Noise Cancellation  
Siri Voice Function

IPX5 sweat & water resistance

**True Wireless Bluetooth Earbuds**

HIFI upgrade sound quality  
The wonderful sound is on the spot

**Lenovo**

**HT10**

True wireless Bluetooth headset

- Qualcomm aptX
- HIFI Pure Bass Sound
- 8 hours Playing time
- 20M Bluetooth connecting

# Lenovo

## Headphones & Earphones



# Lexibook

[www.lexibook.com](http://www.lexibook.com)

NEW BOOMBOXES – RADIO CD PLAYER WITH LICENCES  
OFFICIAL IMAGES FROM THE BEST MOVIES & TV SERIES



# Lexibook

[www.lexibook.com](http://www.lexibook.com)

NEW CHILDREN CD PLAYER WITH 2 MICROFONES INCLUDED –  
SING A LONG



Frozen



Disney Cars



Despicable Me:



Minions & Fluffy



Spiderman



Disney Princess



Peppa Pig



And Paw Patrol !



# Lexibook

[www.lexibook.com](http://www.lexibook.com)

CLOCKS WITH ALL LICENCES & WITH CHARACTERS FROM FILM AND TV



LEXIBOOK®

# Lexibook

[www.lexibook.com](http://www.lexibook.com)

A LOT OF OTHER CONSUMER ELECTRONICS FOR EACH LICENCE,  
JUST ASK FOR YOUR EXPECTED LICENCE !

Nightlight, headphones, bluetooth speakers, walkie-talkies, digital camera, console, DVD player...





# MEE Audio

[www.meeaudio.com](http://www.meeaudio.com)

## BT AUDIO TRANSMITTER & RECEIVER FOR TV



### Universal Dual Headphone and Speaker Bluetooth Audio Transmitter and Receiver for TV

#### HD WIRELESS SOUND FOR YOUR HDTV

The MEE audio Connect Hub integrates seamlessly into new and existing home theater setups to add high-quality wireless audio streaming for headphones, speakers, phones, tablets, and other Bluetooth devices.

#### PRODUCT FEATURES

- **ANALOG AND DIGITAL CONNECTIONS** for compatibility with old and new TVs and other devices; cables included
- **EXTENDED RANGE** design with advanced antenna for up to 90ft of wireless coverage
- **VOLUME BOOST** mode to make RCA/analog audio connections louder
- **BUILT-IN DISPLAY** and **VOICE-ASSISTED SETUP**



#### DIGITAL AND ANALOG CONNECTIVITY

Connects via 3.5mm headphone/AUX jack, RCA, or optical S/PDIF for universal compatibility with old and new TVs and other devices

### connect hub



#### TRANSMITTER (TX) MODE

Stream sound from your TV to up to two Bluetooth headphones or speakers



#### PASS-THROUGH

Share an audio connection from your TV between the Connect Hub and another device



#### RECEIVER (RX) MODE

Stream audio from your phone/tablet to your soundbar or other non-Bluetooth audio device



#### SPECIFICATIONS

Bluetooth version	4.2	number of headphones supported	1 to 2
Bluetooth profiles supported	A2DP	audio inputs / outputs	3.5mm; optical TOSLINK
Bluetooth audio codecs supported	SBC, Qualcomm® aptX™, Qualcomm aptX Low Latency	dimensions	2.2 x 2.2 x 1 inches
operating range	up to 98 ft (30 m)	weight	2.7 oz (79 g)

# Nedis

[www.nedis.com](http://www.nedis.com)

## BT-Speaker for Kids

- Play time: 3hrs.
- 9W
- Mono
- Included microphone
- Linkable

nedis **BLUETOOTH SPEAKER FOR KIDS**



SPBT4100BG



SPBT4100BK



SPBT4100GY



SPBT4100RD



SPBT4110BN



SPBT4110NC



SPBT4110PK



SPBT4110YW

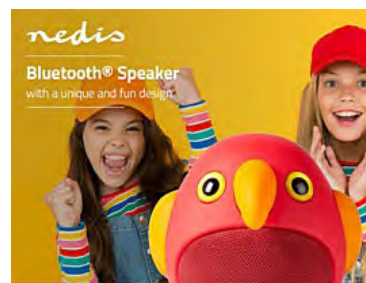

# PartyFunLights

[www.partyfunlights.com](http://www.partyfunlights.com)

PARTY, FUN & LIGHTNING PRODUCTS



## PartySpeakers



Bluetooth  
Karaoke  
Function  
10 Watt



Bluetooth  
2 x 5 Watt



## LED Balloons



# Philips

[www.philips.de](http://www.philips.de)

## VOICE RECORDER



# Platinet

## OUTDOOR BT SPEAKER

### TRAIL

OUTDOOR WIRELESS 2.0 SPEAKERS

Power: 2x 5W Stereo  
Memory foam handle  
IP67 Braided Cover  
360 degree Sound  
Waterproof IPX5  
Bluetooth



**TWS TRUE WIRELESS STEREO**  
CONNECT TWO PLATINET TRAIL BT SPEAKERS TOGETHER TO ENJOY THE BEST SOUND

**IPX5**



**Bluetooth**  
YOUR MUSIC EVERYWHERE

IPX5 WATERPROOF  
360 DEGREE SOUND  
MEMORY FOAM HANDLE  
IP67 BRAIDED COVER  
2X 5W STEREO  
TWS TRUE WIRELESS STEREO



### PEAK

OUTDOOR WIRELESS 2.0 SPEAKER

Power: 2x 5W Stereo  
Memory foam handle  
IP67 Braided Cover  
360 degree Sound  
Waterproof IPX5  
Bluetooth



**TWS TRUE WIRELESS STEREO**  
CONNECT TWO PLATINET PEAK BT SPEAKERS TOGETHER TO ENJOY THE BEST SOUND

**EN** Outdoor speaker for use both around a 40-hour hike with a backpack, as well as at home. IPX5 waterproof, memory foam handle. For use in the most demanding conditions: rain, snow, mud, etc.

**Product features:**

- 2x 5W Stereo (10W total)
- Bluetooth v4.2 (range up to 20m)
- Memory foam handle
- Range up to 10m
- Full battery 220mAh x 2
- Charging time 2.5h
- Charging time up to 10h
- Dimensions: 100 x 150mm
- Weight: 310g

**PL** Protective braided IP67 cover, IPX5 waterproof, memory foam handle. For use in the most demanding conditions: rain, snow, mud, etc.

**Color products:**

- Black + Grey 2x 5W Stereo (10W)
- Blue + Grey 2x 5W Stereo (10W)
- White + Grey 2x 5W Stereo (10W)
- Red + Grey 2x 5W Stereo (10W)
- Orange + Grey 2x 5W Stereo (10W)
- Green + Grey 2x 5W Stereo (10W)
- Purple + Grey 2x 5W Stereo (10W)
- Yellow + Grey 2x 5W Stereo (10W)
- Silver + Grey 2x 5W Stereo (10W)
- Gold + Grey 2x 5W Stereo (10W)

**IPX5**



**Bluetooth**  
YOUR MUSIC EVERYWHERE

IPX5 WATERPROOF  
360 DEGREE SOUND  
MEMORY FOAM HANDLE  
IP67 BRAIDED COVER  
2X 5W STEREO  
TWS TRUE WIRELESS STEREO



### HIKE

OUTDOOR WIRELESS SPEAKER

Power: 6W  
Memory foam handle  
IP67 Braided Cover  
360 degree Sound  
Waterproof IPX5  
Bluetooth



**TWS TRUE WIRELESS STEREO**  
CONNECT TWO PLATINET HIKE BT SPEAKERS TOGETHER TO ENJOY THE BEST SOUND

**IPX5**



**Bluetooth**  
YOUR MUSIC EVERYWHERE

IPX5 WATERPROOF  
360 DEGREE SOUND  
MEMORY FOAM HANDLE  
IP67 BRAIDED COVER  
6W  
TWS TRUE WIRELESS STEREO



### CROSS

OUTDOOR WIRELESS SPEAKER

Power: 5W  
Memory foam handle  
IP67 Braided Cover  
360 degree Sound  
Waterproof IPX5  
Bluetooth



**TWS TRUE WIRELESS STEREO**  
CONNECT TWO PLATINET CROSS BT SPEAKERS TOGETHER TO ENJOY THE BEST SOUND

**IPX5**



**Bluetooth**  
YOUR MUSIC EVERYWHERE

IPX5 WATERPROOF  
360 DEGREE SOUND  
MEMORY FOAM HANDLE  
IP67 BRAIDED COVER  
5W  
TWS TRUE WIRELESS STEREO



# Platinet

## EARPHONES WITH SD-CARD SLOTS

### WIRELESS EARPHONES

MIC & MUSIC CONTROL



Earphones are equipped with Bluetooth technology to connect wirelessly to devices with the same technology (mobile phones, smartphones, tablets, laptops, PCs, etc.). Before connecting, make sure that the device you want to connect the headset is compatible with Bluetooth 4.2 and supports Bluetooth headset and HFP/HSP/A2DP/AVRCP profiles. Headphones have a built-in microphone. Product has a volume and music control.

- BLUETOOTH v4.2**
- Headset & Handsfree, A2DP
  - Battery: 3.7V 60mAh
  - Card reader: play music from microSD cards
  - Power supply: 5V DC
  - Stand by time: 120 hours
  - Playing music time: 4 hours
  - Reach up to: 10 meters
  - Weight: 16g

speaker diameter, średnica głośnika	10 mm
impedance, impedancja	16 ohm
sensitivity, czułość	112 dB
frequency response, pasmo przenoszenia	20Hz-20kHz
input power, moc wejściowa	30 mW

### FASHION EDITION



### Bluetooth



### WIRELESS EARPHONES

MIC & MUSIC CONTROL



Earphones are equipped with Bluetooth technology to connect wirelessly to devices with the same technology (mobile phones, smartphones, tablets, laptops, PCs, etc.). Before connecting, make sure that the device you want to connect the headset is compatible with Bluetooth 4.2 and supports Bluetooth headset and HFP/HSP/A2DP/AVRCP profiles. Headphones have a built-in microphone. Product has a volume and music control.

- BLUETOOTH v4.2**
- Headset & Handsfree, A2DP
  - Battery: 3.7V 60mAh
  - Card reader: play music from microSD cards
  - Power supply: 5V DC
  - Stand by time: 120 hours
  - Playing music time: 4 hours
  - Reach up to: 10 meters
  - Weight: 16g

speaker diameter, średnica głośnika	10 mm
impedance, impedancja	16 ohm
sensitivity, czułość	112 dB
frequency response, pasmo przenoszenia	20Hz-20kHz
input power, moc wejściowa	30 mW

### FASHION EDITION EXTRA HOOK FOR SPORT ACTIVITY



### Bluetooth



### SPORTS EARPHONES

MIC & MUSIC CONTROL



- BLUETOOTH v4.2**
- Headset & Handsfree, A2DP
  - Battery: 3.7V 135mAh
  - Power supply: 5V DC
  - Stand by time: 220 hours
  - Talking time: 4 hours
  - Playing music time: 6 hours
  - Reach up to: 10 meters
  - Weight: 67g



COMFORTABLE NECKBAND



BLUETOOTH 4.2

NECK-HOLDER MAKE IT EASIER TO CARRY

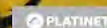

## WIRELESS HEADPHONES

### WIRELESS HEADPHONES WITH BUILT-IN MICROPHONE

**Product features:**

- Bluetooth 4.2
- Support A2DP/HFP/HSP/AVRCP
- Wireless range: up to 10m
- Playing music time: up to 6 hours
- Battery: 250mAh
- Charging time: 2 hours
- Weight: 170g

**Technical parameters:**

- Bluetooth 4.2
- Support A2DP/HFP/HSP/AVRCP
- Wireless range: up to 10m
- Playing music time: up to 6 hours
- Battery: 250mAh
- Charging time: 2 hours
- Weight: 170g

**Specifications:**

Model	FH0921
Color	Black, Red, Blue, White
Weight	170g
Dimensions	180x180x150mm
Material	ABS, PC
Power	5W
Frequency	20Hz-20kHz
Impedance	32Ω
Charging time	2 hours
Playing time	6 hours
Bluetooth version	4.2
Bluetooth profile	A2DP/HFP/HSP/AVRCP
Wireless range	10m
Microphone	Built-in
Microphone type	MEMS
Microphone frequency	100-4000Hz
Microphone sensitivity	-38dB
Microphone SNR	10dB
Microphone impedance	16Ω
Microphone power	10mW
Microphone type	MEMS
Microphone frequency	100-4000Hz
Microphone sensitivity	-38dB
Microphone SNR	10dB
Microphone impedance	16Ω
Microphone power	10mW

**Bluetooth**  
LISTEN YOUR MUSIC WIRELESSLY FROM MOBILE DEVICE OR MICROSD CARD

### WIRELESS HEADPHONES

WITH BUILT-IN MICROPHONE



#### Bluetooth

Headphones are equipped with Bluetooth 4.2 technology to connect wirelessly to any compatible audio source.

#### Product features:

- Bluetooth 4.2 – listen music wirelessly from your mobile device
- Line-in – connect headphones to your smartphone or laptop by mini jack cable
- Built-in microphone for handsfree talking
- USB charging cable and audio cable included

#### Technical parameters:

- Bluetooth 4.2
- Support A2DP/HFP/HSP/AVRCP
- Wireless range: up to 10m
- Battery: 250mAh
- Playing music time: up to 6 hours
- Weight: 170g



**Bluetooth**  
LISTEN YOUR MUSIC WIRELESSLY FROM MOBILE DEVICE

### ACTIVE NOISE CANCELLING WIRELESS HEADPHONES

WITH BUILT-IN MICROPHONE

**FH0928** Headphones are equipped with Bluetooth CSR 4.1 active noise cancelling technology.

It can greatly suppresses noise in the environment. So you can enjoy your music when it is loud outside! Headphones have a built-in microphone, volume control, scrolling melody, pause, ability to receive calls.

#### Product features:

- Bluetooth CSR 4.1 – with ANC
- Line-in – connect headphones by mini jack cable
- Built-in microphone for handsfree talking
- USB charging cable and audio cable included

#### Technical parameters:

- Bluetooth CSR 4.1
- Support A2DP/HFP/HSP/AVRCP
- Wireless range: up to 10m
- Playing music time: up to 8 hours
- Battery: 250mAh
- Charging time: 2 hours
- Weight: 170g



**NOISE CANCELLING**  
REDUCE UNWANTED AMBIENT SOUNDS



**Bluetooth**  
LISTEN YOUR MUSIC WIRELESSLY FROM MOBILE DEVICE



# Promate

[www.promate.net](http://www.promate.net)

## Bluetooth Speaker

- Rainbow LED-Light
- Lumisound Mode
- Music & Call Streaming
- TWS Compatible



LumiSound® 360° Surround Sound Speaker





# Sangean

[www.sangean.eu](http://www.sangean.eu)

RADIOS – DAB+ / FM / BT / Internet



# Sangean

[www.sangean.eu](http://www.sangean.eu)

RADIOS – DAB+ / FM / BT / Internet



# Saramonic

[www.saramonicusa.com](http://www.saramonicusa.com)

## PRO AUDIO EQUIPMENT

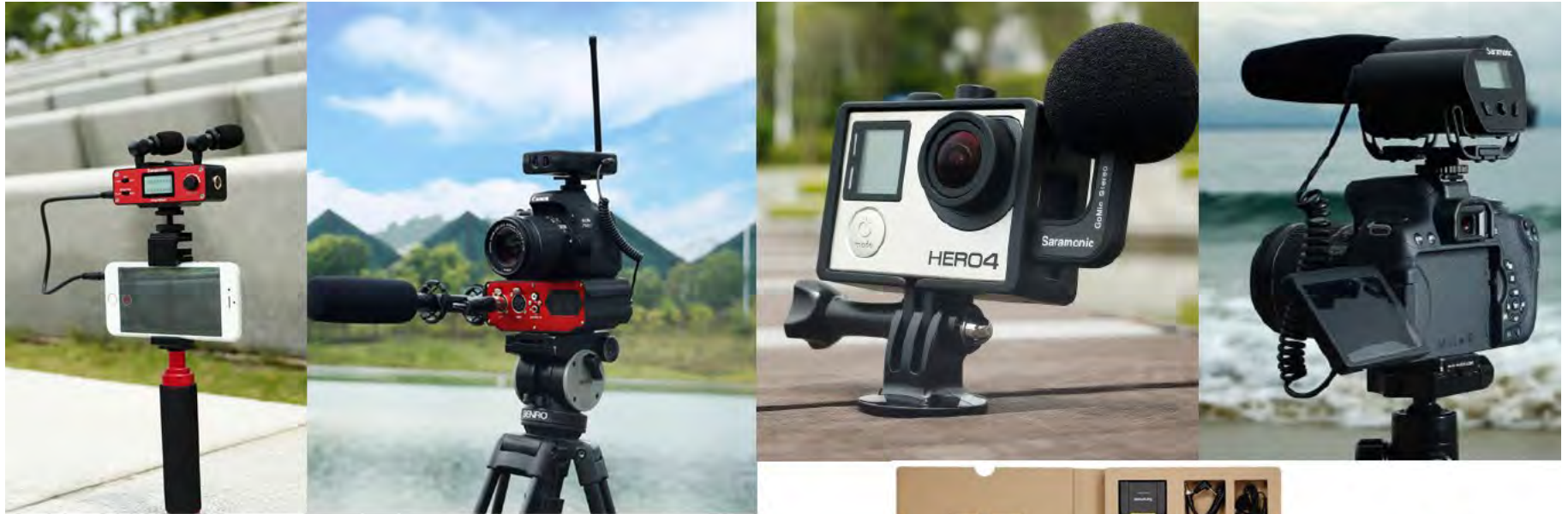

### Smart Mixer

Audio Mixer für  
iOS und Android Geräte

Balanced mini XLR Eingang  
Zwei "plug-in power" Kondensator Mikros  
+48V Phantom Spannung  
Level-Meter  
Kopfhörer-Ausgang  
Lautstärke-Einstellung  
Inklusive zwei Mikros, Gerätehalterung  
& Aluminium-Handgriff  
Stromversorgung: 9V Batterie



### G-Mic

Stereo Mikrofon für  
GoPro Hero 3 / 3+ / 4

Plug & Play  
Frequenzbereich: 35Hz-20KHz  
Electret Kondensator  
Signal/Noise: 80dB SPL



### UwMic9

kabellose UHF Übertragung  
2 x Sender TX9 + Mikro  
1 x Empfänger RX9

# Scosche

## MOUNTS & TRANSMITTER

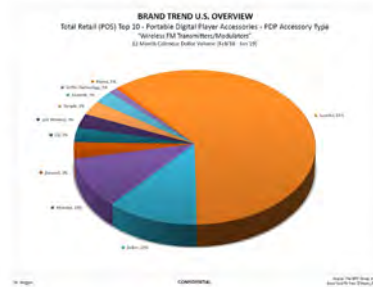

- #1 FM Transmitter Brand
- 61% US Market Share

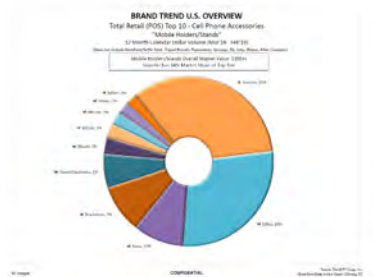

- #1 Overall Mount Brand
- 34% US Market Share

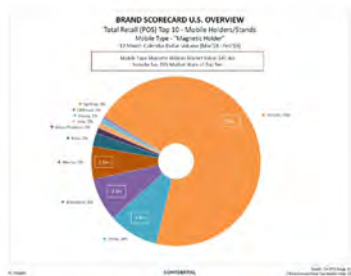

- #1 Magnetic Mount Brand
- 70% US Market Share



# Scosche

## TRANSMITTER

**#1 FM  
TRANSMITTER  
BRAND**



**Bluetooth**

Bluetooth FM Transmitter  
with USB Port



## #1 FM Transmitter Manufacturer In US

Digital FM Transmitter



Bluetooth FM Transmitter  
with USB Port



Universal FM Transmitter

**Plug'n Play Music**  
Simply plug the Aux cable  
into your device

Clear and Crisp Audio Signal  
With 20 Digital Channels

Battery Powered



Built-in 3.5mm Cable



# Skylarx

## Audio and Video Sharing

**SKYLARX**  
LIFE. SHARED  
GET THE BIGGER PICTURE



Had enough of tangled HDMI cable connections? Skylarx is the answer. Less cables, less chaos.

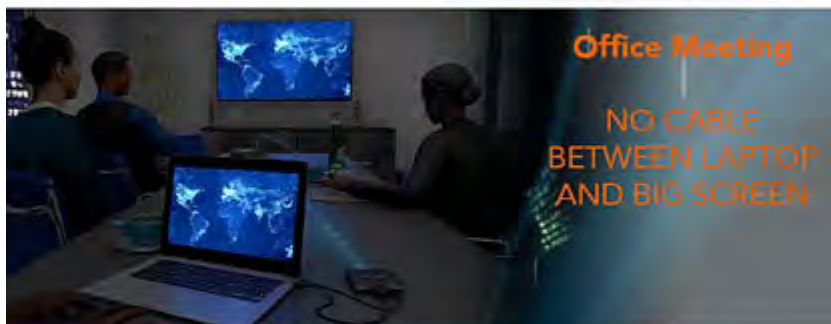

**Office Meeting**  
NO CABLE  
BETWEEN LAPTOP  
AND BIG SCREEN

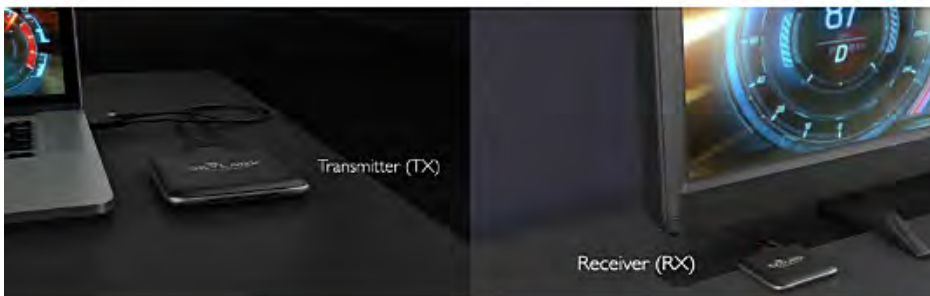

Transmitter (TX)

Receiver (RX)



**Home Video**  
NO CABLE  
BETWEEN LAPTOP  
AND BIG SCREEN



30m line-of-sight  
in room signal coverage.

60GHz interference free link for  
uncompromised video quality.

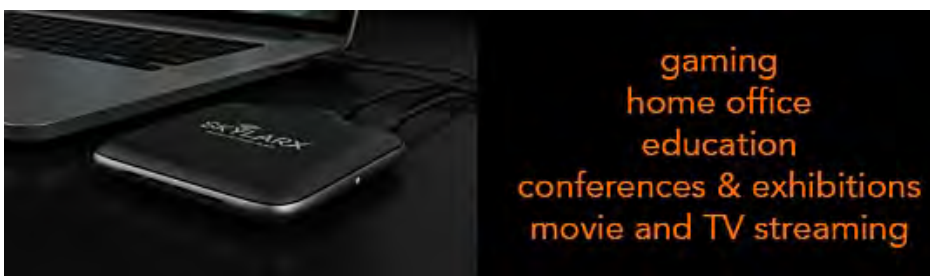

**gaming  
home office  
education  
conferences & exhibitions  
movie and TV streaming**

## HEADPHONES AND SPEAKER

### RUN-UP



Designed headphones

### RUNNER PACK



### CLIP



Back of ear  
Tour d'oreille



### BLUETOOTH® RECEIVER



Bluetooth®  
Wireless Universal

YOUR HEADPHONES BECOME  
BLUETOOTH® & HANDED FREE KEY  
like a regular device.  
Bluetooth® in its place



Designed headphones



UK - CORD



UK - CORD



WOOD



### FIZZ



### SPEAKER WITH STAND



Bluetooth®  
Wireless Universal



### DIGITAL



### SPEAKER BALL



Bluetooth®  
Wireless Universal



### PEACE



## MULTIMEDIA

### MOUSE GUPPY 3



- USB CONNECT
- 3 LED
- RETRACTABLE CORD

### MOUSE GUPPY 3 V.I.P



- USB CONNECT
- 3 LED
- RETRACTABLE CORD

### MOUSE SMILIGHT

- USB POWERED
- LUMINOUS



### MOUSE ERGO VERTICAL WIRELESS

- x6 ERGONOMIC BUTTONS
- LASER PRECISION
- DPI SWITCH DPI
- ULTRA COMPACT
- WIRELESS



- PC & MAC
- MW ERGONOMIC MOUSE

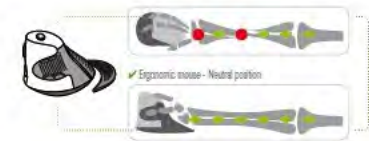

### MOUSE ERGO VERTICAL

- x6 ERGONOMIC BUTTONS
- HIGH PRECISION
- ULTRA COMPACT
- SWITCH DPI



- PC & MAC
- MW ERGONOMIC MOUSE

### TS UK

- HIGH PRECISION



- TS UK DESIGN

### TS NY

- HIGH PRECISION



- TS NY DESIGN

### KEYBOARD E-LUMINOUS



- PC & MAC
- KBLIGHT BACKLIGHT
- SOFT KEYS
- BACKLIGHT
- 10 MEMORIES TEST

### KEYBOARD BLUETOOTH



- PC & MAC
- KRBT PC1 UNIVERSAL IOS / ANDROID / WINDOWS
- SOFT KEYS
- BLUETOOTH WIRELESS

### HUB FLASH 3.0

- x4 PORTS USB
- 3.0 X10 FASTER
- 5 USB ULTRA SPEED



- PC & MAC
- HUB USB3 ULTRA SPEED

### TS BLACK UK

- HIGH PRECISION
- MOUSE INCLUDE



- BLUMERUK DESIGN

### TS ANTI-SLIDE

- ULTRA SLIM



- TS ANTI ANTI-SLIDE

### SPEAKERS MX 2.1

AVAILABLE IN 2 COLORS

- 16W RMS
- USB POWERED
- VOLUME CONTROL
- BASS CONTROL

- PC & MAC
- HPMX21BK (BLACK)
- HPMX21WR (WHITE)
- WOODEN SUBWOOFER WITH MAX SOUND



### CHARGER CHNBUN140

- 100W-20W
- 7 ADAPTORS
- 40W 40W MAX
- 13 UP TO 12"



### SURGE PROTECTOR STORM

- 240V-70°C
- PROTECT 400-100US
- USB X2 1A-2.1A



NEW! Product

### HUB ALU

- x7 PORTS USB
- USB 2.0
- CHARGER INCLUDE



- PC & MAC
- HUB USB2 ALU DESIGN

- PC & MAC
- HUB USB4 ALU DESIGN



- x4 PORTS USB





# Trevi

## Karaoke Produkte



# Trevi

[www.trevi.it](http://www.trevi.it)

## RADIOWECKER MIT DAB+/FM-RADIO UND USB LADEANSCHLUSS



### Trevi RC80D6 DAB

- DAB+ und FM-Radio
- USB-Anschluss mit Auflade-Funktion (Ausgangsleistung 1A)
- Programmierbarer Wecker mit Radio / Klingelton
- Großes LED-Display
- AUX-IN-Eingang
- SLEEP-Funktion
- SNOOZE-Funktion
- Spannungsversorgung: 5V 1,5A mit 230V ~ 50Hz
- Abmessungen: 155 x 63 x 79 mm

## MINI BLUETOOTH HEADSET

### HMP 1220 AIR



- Mini Bluetooth headset
- Listen and talk wirelessly, from smartphones, tablets ...
- BT V4.2 + EDR
- Built-in microphone for phone calls
- Case / rechargeable base by micro usb for earphones recharge
- Rechargeable lithium batteries

## BOOM BOXEN



■ 0054202  
■ 0054201  
■ 0054204  
■ 0054215

### CMP 542 USB

PORTABLE STEREO RADIO WITH CD / MP3 / USB PLAYER

- CD/CD MP3 Player
- USB input for connecting portable MP3
- LCD Display
- Stereo headphone jack
- AM / FM stereo
- Maximum power output: 6W
- Power Supply: AC 230V/50Hz - 6 Battery "C" size (UM2)
- Dimensions: 220 x 240 x 130 mm



■ 0057402

■ 0057404



■ 0065500  
■ 0065500  
■ 0065509

### CMP 550 USB

PORTABLE STEREO RADIO WITH CD/MP3/USB PLAYER

- MP3, CD, CD-R/RW Player
- USB input for connecting portable MP3
- LCD Display
- Stereo headphone jack
- Aux-in
- FM stereo
- Maximum power output: 2x1.2W
- Power Supply: Mains: 100-240V - 50/60Hz power supply 9V DC adapter
- Batteries: 6 "C" size (UM2)
- Dimensions: 220 x 240 x 130 mm



### CMP 574 USB

PORTABLE CASSETTE RECORDER RADIO STEREO WITH CD / MP3 / USB

- AM / FM stereo with digital frequency
- Stereo cassette player recorder with automatic recording level ALC and Autostop function
- CD/CD MP3 Player
- USB input for direct playback of MP3 files
- Stereo headphone jack
- Maximum Output Power: 20W
- Power Supply: AC 230V/50Hz - 8 batteries "D" size (UM1)
- Dimensions: 385 x 195 x 240 mm



■ 0063202



■ 0063205

■ 0063205



■ 0065300  
■ 0065302  
■ 0065303

433-18

### CMP 524 MP3

PORTABLE STEREO RADIO WITH CD/MP3 PLAYER

- CD Audio / MP3 player
- USB input
- AM/FM bands
- Headphone socket
- Maximum power output: 2.4W
- Power supply: AC 230V/50Hz
- 6 Batteries x "C" (UM2) not included
- Dimension: 228x207x112 mm



### CMP 532 USB

PORTABLE STEREO RADIO WITH CD/MP3/USB PLAYER

- CD/CD MP3 Player
- USB input for connecting portable MP3
- LCD Display
- Aux In
- AM / FM stereo
- Power Supply: AC 230V/50Hz - 6 Battery "C" size (UM2)
- Dimensions: 215 x 200 x 110 mm



## RADIO / MINI RADIO



**DR 750 BT** **BLUETOOTH** **HANDS FREE** **HIGH QUALITY SOUND**

RADIO FM / BLUETOOTH® / LETTORE MP3-USB-MICROSD

- Portable Radio FM SCAN with Autotune search
- Bluetooth®
- MP3 player from Micro SD card/USB
- Handsfree function for conversations
- Microphone built-in
- LED display and the frequency / function used
- Voice Announce for each functions (English Language)
- 3W max High Quality Sound
- Power supply: lithium battery rechargeable by mini-usb cable
- Dimensions: 97 x 97 x 66mm
- Weight: 300g

0075004  
0075001  
0075009



**RA 763 V** **VINTAGE DESIGN** **AC / DC** **PORTABLE**

PORTABLE RADIO DUAL BAND

- Portable radio dual band
- AM / FM
- Headphone jack
- Power Supply: AC 230V - 50Hz
- Batteries: 4x 1C (LM2)
- Dimensions: 210x140x80 mm

0076301  
0076302  
0076303  
0076305  
0076312



**RA 768 S** **AC / DC** **PORTABLE** **HIGH POWER**

RADIO PORTATILE 2 BANDE

- Portable radio dual band
- AM / FM
- High power
- Headphone jack
- Power Supply: AC 230V - 50Hz
- Batteries: 4x 1C (LM2)
- Dimensions: 210x140x80 mm

00A76801  
00A76802  
00A76809



**RA 762** **VINTAGE DESIGN** **AC / DC** **PORTABLE**

PORTABLE RADIO DUAL BAND

- Portable radio dual band
- AM / FM
- Headphone jack
- Power Supply: AC 230V - 50Hz
- Batteries: 4x 1C (LM2)
- Dimensions: 210x160x75 mm

0076204  
0076206



**RA 764** **AC / DC** **PORTABLE** **TRENDY**

PORTABLE RADIO DUAL BAND

- Portable radio dual band
- AM / FM
- Headphone jack
- Power Supply: AC 230V - 50Hz
- Batteries: 4x 1C (LM2)
- Dimensions: 207x110x62 mm

0076400



0076501

# Wraps

## BT Go Headphones

- Unique memory wire design
- Superior feel and secure fit
- Powerful 8 hour battery life
- Graphene drivers
- BT version 5
- Comfort auto fit

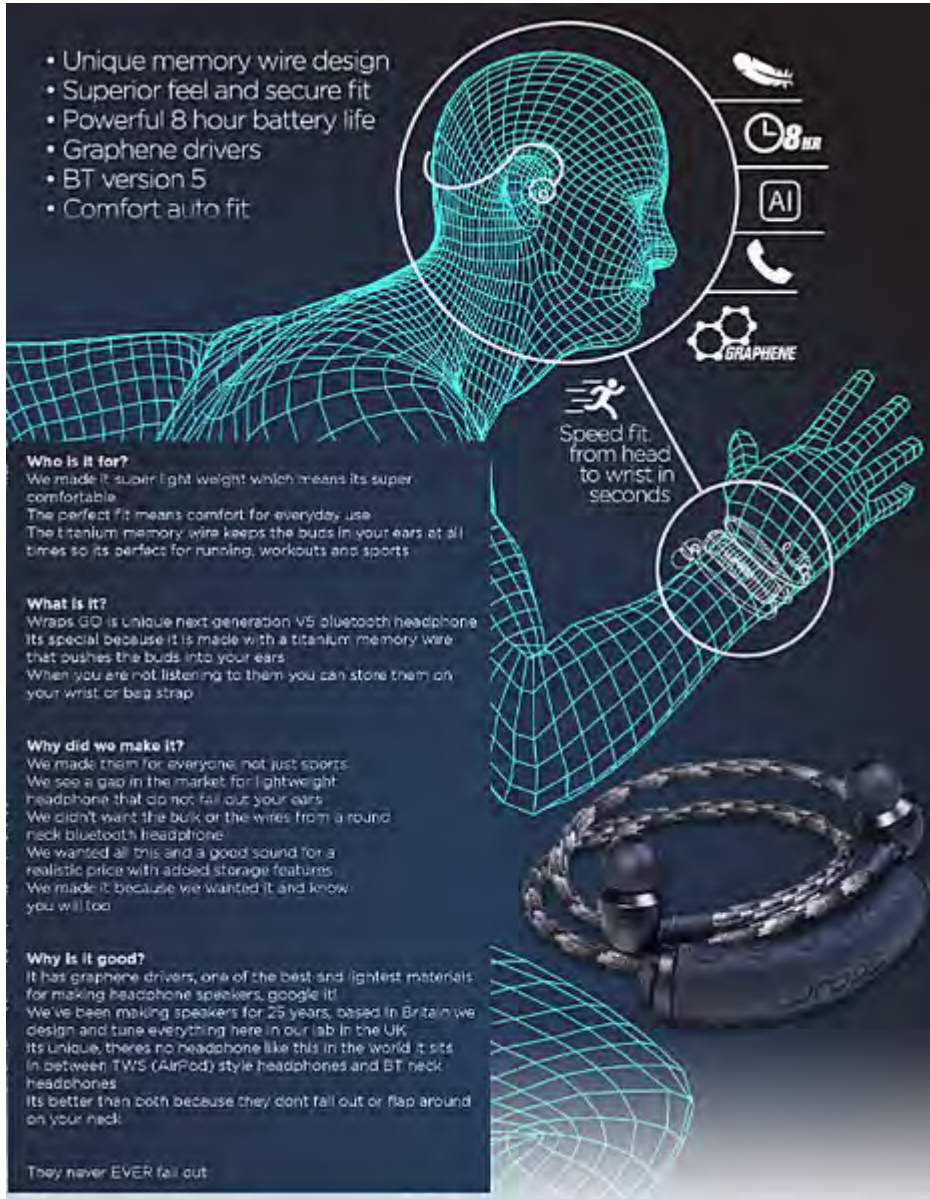

**Who is it for?**  
We made it super light weight which means its super comfortable.  
The perfect fit means comfort for everyday use.  
The titanium memory wire keeps the buds in your ears at all times so its perfect for running, workouts and sports.

**What is it?**  
Wraps GO is unique next generation V5 bluetooth headphone.  
Its special because it is made with a titanium memory wire that pushes the buds into your ears.  
When you are not listening to them you can store them on your wrist or bag strap.

**Why did we make it?**  
We made them for everyone, not just sports.  
We see a gap in the market for lightweight headphone that do not fall out your ears.  
We didn't want the bulk or the wires from a round neck bluetooth headphone.  
We wanted all this and a good sound for a realistic price with added storage features.  
We made it because we wanted it and know you will too.

**Why is it good?**  
It has graphene drivers, one of the best and lightest materials for making headphone speakers, google it!  
We've been making speakers for 25 years, based in Britain we design and tune everything here in our lab in the UK.  
Its unique, theres no headphone like this in the world. It sits in between TWS (AirPod) style headphones and BT neck headphones.  
Its better than both because they dont fall out or flap around on your neck.

They never EVER fall out

Speed fit, from head to wrist in seconds

8 HR  
AI  
GRAPHENE

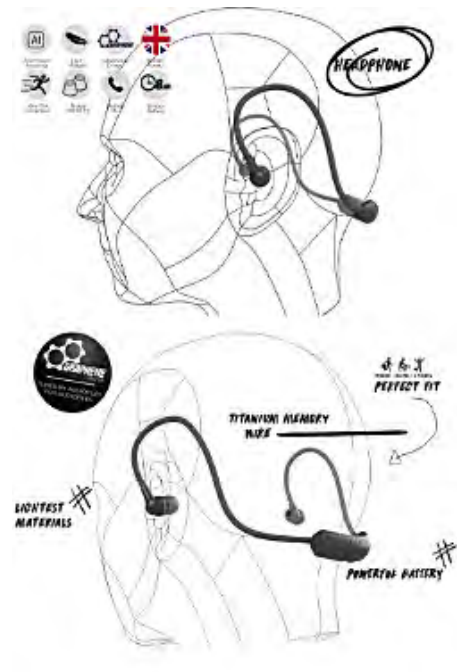

**wraps**  
WHISTBAND HEADPHONES

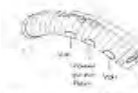

# Wraps

[www.mywraps.com](http://www.mywraps.com)

## PATENTED EARPHONES



- Wraps
- Patentiertes Verschlusssystem - nie mehr Kopfhörer verknoten oder suchen
  - Ein-Tasten Mikrofon (nicht bei Classic)
  - Kabellänge: 1,2 m
  - Frequenzbereich 20Hz - 20KHz
  - Impedanz: 16 Ohm
  - Empfindlichkeit: 80dV/1mW
  - Max Power: 10mW
  - Treiber: 10 mm
  - Stecker: 3,5 Klinke



# Wraps

[www.mywraps.com](http://www.mywraps.com)

## USB/LIGHTNING POWER CABLES

**POWER CABLES**  
with a twist

#WEAR YOUR POWER

**wraps**  
WEARABLE CHARGE CABLES

**KEY FEATURES**

WRAPS cables are rated over 2.4amps vs many inferior cables rated at just 1amp. Subject to your device, this allows safe, super fast charging.

**CONNECTORS**

Our audio connectors are custom moulded to the highest Apple MFi standards. USBs use high grade aluminium housing and robust quality components and feature a thumb grip.

**THE CLASP**

Our stylish clasp is what allows you to connect the two ends of your cable to wear as a wristband, wrap around your phone or power bank, or just keep things neat and tangle free. The patented design means this can be adjusted to fit any size wrist or object.



Made for **iPod iPhone iPad**

**USB → LIGHTNING CHARGE CABLE**

**SPEC**  
2.4amp fast charging  
MFi certified  
High grade aluminium housing  
Robust quality components  
Patented clasp design

Lightning Cable  
Lightning Cable  
Lightning Cable

**FAST CHARGE**

**LIGHTNING**

iPhone iPad iPod

Made for **iPod iPhone iPad**

**USB → MICRO CHARGE CABLE**

**SPEC**  
2.4amp fast charging  
MFi certified  
High grade aluminium housing  
Robust quality components  
Patented clasp design

Micro Cable  
Micro Cable  
Micro Cable

**FAST CHARGE**

**MICRO**

Made for **iPod iPhone iPad**

**USB-C → USB-C CHARGE CABLE**

**SPEC**  
2.4amp fast charging  
MFi certified  
High grade aluminium housing  
Robust quality components  
Patented clasp design

USB-C Cable  
USB-C Cable

**FAST CHARGE**

**USB-C TO USB-C**

Made for **iPod iPhone iPad**

**USB → USB-C CHARGE CABLE**

**SPEC**  
2.4amp fast charging  
MFi certified  
High grade aluminium housing  
Robust quality components  
Patented clasp design

USB-C Cable  
USB-C Cable

**FAST CHARGE**

**USB-C**

Made for **iPod iPhone iPad**

**USB → LIGHTNING CHARGE CABLE**

**SPEC**  
2.4amp fast charging  
MFi certified  
High grade aluminium housing  
Robust quality components  
Patented clasp design

Lightning Cable  
Lightning Cable  
Lightning Cable  
Lightning Cable

**FAST CHARGE**

**LIGHTNING COPE**

iPhone iPad iPod





MOBILE CHARGER

# Cygnett

## ChargeUp Edge+ 27k Powerbank

20K USB-C Power Bank + USB-C to USB-C Cable

### Specifications

- Battery type & Size: 27,000 mAh/ 99.99Wh
- Input: USB-C PD Input: 30W
- Output: USB-C PD Output 1 - 60W
  - USB-C PD Output 2 - 12W
  - USB-A PD Output 3 - 12W
- Wireless Output: 10W
- Total Output: 72W
- Integrated 10cm USB-C to USB-C cable



Charge 4 devices simultaneously



Supports 10W Wireless charging



Integrated USB-C to USB-C cable



Charge USB-C Laptops



## USB-C / POWER DELIVERY CHARGER

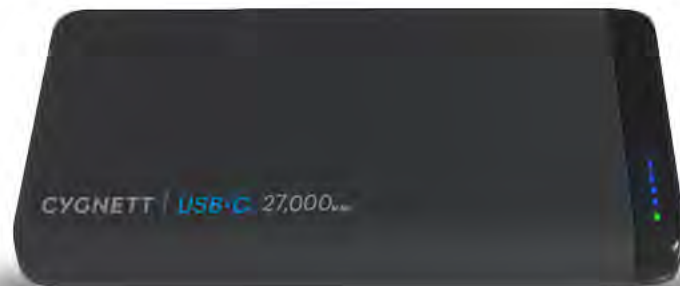

## ChargeUp Pro 27K with Power Delivery Laptop Power Bank 27K USB-C

### Product Specifications

Capacity: 27,000mAh/99.9Wh,

Lithium Polymer Battery,

Dimensions: 181x104x22.3mm

USB-C input: 5V-3A, 14.5V-2A,  
20V-1.5A (30W)

USB-C Output 1: 5V-3A, 9V-3A, 12V-3A,  
14.5V-3A, 20V-3A (60W)

USB-C Output 2: 5V-2.4A (12W)

USB-A Output 1: 5V-2.4A (12W)

**Total Output: 72W (Max)**

Minimum operating temperature: 25°C

Maximum operating temperature: 40°C



# Energizer Powerbanks

<https://www.energizer.com/>

## Powerbanks



**QE10012PQ** (28W)

**QE20007PQ**



**XP20002PD**  
(for laptops )



**UE20011PQ**



# Energizer Powerbanks

## Powerbanks



### Fast Charging

Smart USB-A 18W provides fast charge for Samsung, Huawei, and other Android devices.



### 3 Outputs

Two USB-A and one USB-C output that can charge 2 devices at once.



### Power Delivery

USB-C out/input port with Power Delivery that can provide fast charge to new iPhones from 0% to 50% in only 30 minutes, and other USB-C devices.



### Dual Inputs

1 USB-C and 1 micro-USB inputs can recharge based on your convenience. Fast recharge through USB-C and with compatible cable and adapter.



### PowerSafe

Guarantees against short circuit, and over-charging for your portable battery and devices.



# GP Batteries

## Trav O Save – LITHIUMFREIE POWERBANK

TRAV O SAFE enthält kein reaktives Lithium, das chemische Reaktionen eingeht.

# TRAV O SAFE



### Die IATA stuft Lithium-Akkus als Gefahrgut ein.



- Ersatz-Lithium-Akkus für alle Geräte (<160 W Energie) **können NICHT aufgegeben werden.**
- Geräte mit integrierten Lithium-Akkus (>160 W Energie) **sind überhaupt NICHT erlaubt**
- Tragbare PowerBanks **dürfen NICHT aufgegeben werden** sind nur im Handgepäck erlaubt (< 25.000 mAh)



Lithium-frei\*



Sicher



Zuverlässig



Energieversorgung mit ReCyko+ Nickel-Metallhydrid (NiMH)-Akkus. Die sicherere Alternative zu Lithium.

Vollständige Einhaltung der  **Gefahrgutvorschriften**, sicher für **aufgegebenes** und Handgepäck.

- Sicherheit und Schutz bei**
- Über- und Untertemperatur
  - Überstrom
  - Überladung
  - Tiefentladungsspannung
  - Kurzschluss



## ECO BATTERY

### ELARI EcoBattery

Real money saving

AA batteries with USB charging.  
No special wire or recharging device  
needed.

It's enough to find a free port of USB



Save your budget, saving the Planet!  
1 EcoBattery = 500 batteries  
500 batteries = 3 kg of toxic waste  
500 batteries = \$1000



ELARI  
EcoBattery

- Charges via any USB output
- Up to 500 charge/discharge cycles
- Built-in multicolor LED indicator
- Auto shut off at full charge
- Weight: 20 g, dimensions 14 x 50 mm
- Charging time: up to 3 hours
- Capacity 1200 mAh, 1.2 V (60-80% of usual disposable battery)\*
- Working conditions: from 0 to 45 °C
- Storage conditions: from -10 to 60 °C
- Charge current: up to 400 mA

\*Average capacity of usual Zinc-carbon (R6) and Alkaline (LR6) batteries is 1500-2000 mAh

AA EcoBattery with USB recharging: eco-friendly and cost effective AA battery alternative  
AA EcoBattery with USB recharging: eco-friendly and cost effective AA battery alternative  
ELARI EcoBattery solves the problem of powering any device requiring AA batteries. It withstands up to 500 charge cycles, so 1 EcoBattery replaces 500 disposable ones, which would harm the planet with their chemicals! To charge it just open the cap and insert ELARI EcoBattery into a USB port, and it will be fully charged within 3 hours or less.



# Platinet

www.platinet.eu

## PORTABLE CHARGER IN MANY DESIGNS AND SIZES

**Omega Power Bank**  
with Knitcorder built in

RECOMMENDED FOR Smartphones, Music Players, Tablet PCs and other TV devices

**1152 mAh CREDIT BANK**

Smartphone Full Charging Cycle

Lightning plug adapter

Capacity	Full Smartphone Charge
2200mAh	1
4400mAh	2
6600mAh	3
8800mAh	4
11000mAh	5
13200mAh	6
15400mAh	7
17600mAh	8
19800mAh	9
22000mAh	10

**Platinet POWER BANK**

RECOMMENDED FOR Smartphones, Music Players, Tablet PCs and other TV devices

**6000mAh LUXURY LEATHER PATTERNDISIGN**

2018 PC WORLD *Product*

READY TO USE

charging indicator

Capacity	Full Smartphone Charge
2200mAh	1
4400mAh	2
6600mAh	3
8800mAh	4
11000mAh	5
13200mAh	6
15400mAh	7
17600mAh	8
19800mAh	9
22000mAh	10

**Platinet POWER BANK**

RECOMMENDED FOR Smartphones, Music Players, Tablet PCs and other TV devices

**10000mAh POLYMER BATTERY**

READY TO USE

charging indicator

Capacity	Full Smartphone Charge
2200mAh	1
4400mAh	2
6600mAh	3
8800mAh	4
11000mAh	5
13200mAh	6
15400mAh	7
17600mAh	8
19800mAh	9
22000mAh	10

**Platinet POWER BANK**

RECOMMENDED FOR Smartphones, Music Players, Tablet PCs and other TV devices

**8000mAh POLYMER BATTERY**

READY TO USE

charging indicator

Capacity	Full Smartphone Charge
2200mAh	1
4400mAh	2
6600mAh	3
8800mAh	4
11000mAh	5
13200mAh	6
15400mAh	7
17600mAh	8
19800mAh	9
22000mAh	10

**Platinet POWER BANK**

RECOMMENDED FOR Smartphones, Music Players, Tablet PCs and other TV devices

**5200mAh LUXURY LEATHER PATTERNDISIGN**

60% FASTER CHARGING

READY TO USE

Capacity	Full Smartphone Charge
2200mAh	1
4400mAh	2
6600mAh	3
8800mAh	4
11000mAh	5
13200mAh	6
15400mAh	7
17600mAh	8
19800mAh	9
22000mAh	10

**Platinet POWER BANK**

RECOMMENDED FOR Smartphones, Music Players, Tablet PCs and other TV devices

**6000mAh LUXURY LEATHER PATTERNDISIGN**

60% FASTER CHARGING

READY TO USE

Capacity	Full Smartphone Charge
2200mAh	1
4400mAh	2
6600mAh	3
8800mAh	4
11000mAh	5
13200mAh	6
15400mAh	7
17600mAh	8
19800mAh	9
22000mAh	10

**Platinet POWER BANK**

RECOMMENDED FOR Smartphones, Music Players, Tablet PCs and other TV devices

**2000mAh**

READY TO USE

USB Charging Cable included

Capacity	Full Smartphone Charge
2200mAh	1
4400mAh	2
6600mAh	3
8800mAh	4
11000mAh	5
13200mAh	6
15400mAh	7
17600mAh	8
19800mAh	9
22000mAh	10

**Platinet POWER BANK**

RECOMMENDED FOR Smartphones, Music Players, Tablet PCs and other TV devices

**6000mAh**

READY TO USE

USB Charging Cable included

Capacity	Full Smartphone Charge
2200mAh	1
4400mAh	2
6600mAh	3
8800mAh	4
11000mAh	5
13200mAh	6
15400mAh	7
17600mAh	8
19800mAh	9
22000mAh	10

**Platinet POWER BANK**

RECOMMENDED FOR Smartphones, Music Players, Tablet PCs and other TV devices

**8000mAh**

FLASHLIGHT FUNCTION

READY TO USE

charging indicator

Capacity	Full Smartphone Charge
2200mAh	1
4400mAh	2
6600mAh	3
8800mAh	4
11000mAh	5
13200mAh	6
15400mAh	7
17600mAh	8
19800mAh	9
22000mAh	10



# Powertraveller

[www.powertraveller.com](http://www.powertraveller.com)

## PORTABLE CHARGER FOR TRAVELLERS



Die Reise dauert länger als gewünscht, am Platz keine Ladebuchse, der Laptop hat keinen Saft mehr.

### Die Lösung:

#### Powertraveller mini-G

klein, leicht, kraftvoll. Lädt Ihr Notebook schnell bis zu 50% auf. Das bringt 2-4 Stunden mehr Business-Power.



### MINI-G ROBUSTER 5V-19V HIGH-TECH CHARGER

12.000 mAh



### POWERGORILLA STARKER 5V-24V HIGH-TECH CHARGER



### 24.000 mAh DAS KRAFTPAKET FÜR STROMFREIE TOUREN

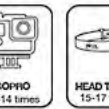
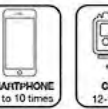
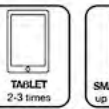

# Powertraveller

## POWER PACKS

### CONDOR 100

**MULTI -VOLTAGE POWER PACK WITH AC OUTLET T**  
**LADEGERÄT MIT MEHRFACHSPANNUNG + AC AUSGANG**

Highly-versatile, multi-voltage power pack with integrated AC outlet for charging laptops, SLR cameras, smartphones, and other 5V to 20V, 110V and 220V devices. Waterproof & Dustproof to IP65 Rating.

**SPECIFICATIONS:**

- Power pack with 27000mAh/99.9Wh
- Rugged, rubberised coating
- Waterproof & Dustproof to IP65 Rating
- 4 LED battery charge indicator
- 1x AC output: 110V/AC/60Hz or 220V/AC/50Hz
- 1x USB-C input/output: PD 45W
- 1x USB output: 5V/2.4A
- 1x USB output: 5V/3A Quick Charge
- Weight: 450g
- Size: 172mm x 85.5mm x 85.5mm

**KIT INCLUDES:**

- 1x Condor power pack
- 1x USB-C to USB-C cable
- 1x USB-C main charger, with 1 USB-C PD 45W port and 1 USB 5V/2.4A Smart Charger port.



### PHOENIX 90

**MULTI -VOLTAGE CHARGER**  
**MULTIPLA LADEGERÄT MIT MEHRFACHSPANNUNG**

Powerful, multi-voltage power pack for charging laptops, SLR cameras, smartphones, and any other 5V to 20V devices. Waterproof & Dustproof to IP65 Rating.

**SPECIFICATIONS:**

- Multi-voltage power pack with 22500mAh/83.3Wh
- Rugged design
- Waterproof & Dustproof to IP65 Rating
- 1x USB-C input/output: PD 45W
- 1x DC output: 12V, 16V, 19V - 4A Max
- 1x USB output: 5V/3A Quick Charge
- 1x USB output: 5V/2.4A
- 45W LED screen
- Size: 139mm x 139mm x 31.5mm
- Weight: 600g

**KIT INCLUDES:**

- Phoenix 90 power pack
- 1x USB-C to USB-C cable
- 1x USB-C main charger, with 1 USB-C PD 45W port and 1 USB 5V/2.4A Smart Charger port



### MERLIN 15

**POWER PACK**  
**LADEGERÄT**

Ultra-lightweight, rugged power pack for charging smartphones, action cameras, SAT phones, and other 5V devices. Smart charging technology detects when devices are connected, disconnected, or fully charged. Integrated 100 Lumens torch with SOS settings. Waterproof & Dustproof to IP65 Rating.

**SPECIFICATIONS:**

- Power pack with 3350mAh/12.4Wh
- Rugged design
- Waterproof & Dustproof to IP65 Rating
- Integrated 100 Lumens torch with SOS settings
- 1x USB-C input/output: 5V/1.5A
- 1x USB output: 5V/1.5A
- 4 LED battery charge indicator
- Weight: 100g
- Size: 107mm x 28mm x 38mm

**KIT INCLUDES:**

- 1 x Merlin 15 power pack
- 1 x USB-C to USB cable



### MERLIN 75

**MULTI -VOLTAGE POWER PACK**  
**MULTI-VOLTAGE LADEGERÄT**

Portable, rugged power pack for charging laptops, tablets, smartphones, and other 5V devices. Smart charging technology detects when devices are connected, disconnected, or fully charged. Integrated 100 Lumens torch with SOS settings. Waterproof & Dustproof to IP65 Rating.

**SPECIFICATIONS:**

- Power pack with 19200Ah/71Wh
- Rugged design
- Waterproof & Dustproof to IP65 Rating
- Integrated 100 Lumens torch with SOS settings
- 1xUSB-C input/output: PD 30W
- 1x USB output: 5V/3A Quick Charge
- 4 LED battery charge indicator
- Weight: 340g
- Size: 175mm x 42mm x 57mm

**KIT INCLUDES:**

- Merlin 75 Power Pack
- 1x USB-C to USB cable



# Powertraveller

[www.powertraveller.com](http://www.powertraveller.com)

## PORTABLE CHARGER FOR EXTREME SITUATIONS

Introducing the new  
**DISCOVERY**

**she can.**  
message from the mountain.



Award winning portable power solutions for all your devices.  
Stay off-grid longer.



Introducing the new  
**EXTREME SOLAR**

**they can.**  
tweet from the track.



Introducing the new  
**EXTREME**

**he can.**  
call from the kayak.



Introducing the new  
**MINI-G**

**you can.**  
talk from the trail.



**SOLARMOKEY  
ADVENTURER**

Made for  
iPod iPhone iPad

**POWERGORILLA**



**SOLARGORILLA**



Made for  
iPod iPhone iPad

YOU CAN CHARGE:



# Powertraveller

[www.powertraveller.com](http://www.powertraveller.com)

## TACTICAL RANGE

### EXTREME TACTICAL

#### SOLAR KIT

KIT PANNEAU SOLAIRE | KIT PANEL SOLAR | KIT PANNELLO SOLARE | SOLARPANEL KIT

Versatile power pack for charging smartphones, action cameras, SAT phones, and other 5V and 12V devices with the power of the sun. Dust tight and waterproof.

#### RECHARGES:

RECHARGE | RECARGA | RICARICA | LÄDT AUF



TABLET 1-2x  
SMARTPHONE 3-5x  
SAT PHONE 3-4x  
GPS 7-8x  
ACTION CAMERA 7-8x  
SLR CAMERA 2-5x  
SMARTWATCH 20-22x  
HEAD TORCH 5-7x

#### POWER PACK SPECIFICATIONS:

SPECIFICATIONS | ESPECIFICACIONES  
SPECIFICAS | SPECIFIKATIONEN

- Power pack with 12,000mAh /44Wh
- 1x Bi-directional USB-C input/output (5V 2A)
- 1x DC output (12V)
- 1x USB output (5V 1A)
- 4 LED battery charge indicator
- Automatic device detection
- Rugged outer casing
- Water-resistant
- Permanent on/off feature
- Weight: 274g
- Size: 136mm x 78mm x 22mm

#### SOLAR PANEL SPECIFICATIONS:

SPECIFICATIONS | ESPECIFICACIONES  
SPECIFICAS | SPECIFIKATIONEN

- 5W clamshell solar charge
- 1x USB output (5V 1A)
- 5 Watt
- 2-colour LED indicator to show power output strength
- Clamshell design
- MPPT Technology
- Opens to 220°
- Weight: 283g
- Size: 200mm x 114mm x 8mm (folded)



#### MULTI-VOLTAGE CHARGER

CHARGEUR MULTI TENSION | CARGADOR DE MULTIPLE VOLTAJE | CARICABATTERIE VOLTAGGIO MULTIPLO | LADEGERÄT MIT MÖHRFACHSPANNUNG

The ultimate, multi-voltage laptop charger providing an additional 2-5 hours of power to your laptop, and over 20 hours on various other electronic devices. Charges 5V, 12V, 16V, 19V, and 24V products. Made from hard-wearing, durable materials.

#### RECHARGES:

RECHARGE | RECARGA | RICARICA | LÄDT AUF



LAPTOP (<40W) 1x  
TABLET 2-3x  
SMARTPHONE 10x  
SAT PHONE 3-5x  
GPS 15-17x  
ACTION CAMERA 10-16x  
SLR CAMERA 4-6x  
SMARTWATCH 40x  
HEAD TORCH 15-17x

#### SPECIFICATIONS:

SPECIFICATIONS | ESPECIFICACIONES  
SPECIFICAS | SPECIFIKATIONEN

- Power pack with 24,000mAh /88Wh
- Input: 15-25V, 1.5-4A Max
- DC output: 12V, 16V, 19V, 24V
- USB output: 5V/2.4A Max
- UPS feature on 19V setting
- Weight: 700g
- Size: 215mm x 130mm x 17mm

#### KIT INCLUDES:

INCLUS DANS LE KIT | EL KIT INCLUDE  
IL KIT INCLUDE | KIT BEINHALTET

- Powergorilla portable charger
- 1x Universal 19V AC mains charger
- 1x DC extension cable (80cm)
- 1x Female 12V socket
- Laptop tip set (10 pieces)
- 1x USB to USB-C cable
- 1x USB-C to micro USB adaptor
- Neoprene case



# Powertraveller

## TACTICAL / CIVILIAN



**POWERTRAVELLER**

### SOLARGORILLA TACTICAL

Dur multi-voltage solar charger is capable of charging laptops under 40W.

**RECHARGES:**  
RECHARGE | RECARGA | RICARICA | LÄDT AUF



LAPTOP (<40W) | TABLET | SMARTPHONE | SAT PHONE | GPS | ACTION CAMERA | SLR CAMERA | SMARTWATCH | HEAD TORCH

**SPECIFICATIONS:**  
SPECIFICACIONES | ESPECIFICACIONES | SPECIFIKATIONEN

- 10W multi-voltage, clamshell solar charger
- 1x USB output: 5V /2A
- 1x DC output: 20V /0.5A
- Weight: 700g
- Size: 264mm x 200mm x 19mm (folded)

**KIT INCLUDES:**  
INCLUS DANS LE KIT | EL KIT INCLUDE | KIT BEIHALTET

- Solargorilla
- 1x DC extension cable (2m)
- 1x USB extension cable (2m)
- 1x USB-C to USB cable
- 1x USB-C to micro USB adaptor
- 1x Female 12V socket
- 1x laptop tips set (10 pieces)
- Velcro strap
- Neoprene case







## POWERTRAVELLER CIVILIAN



FALCON 40



FALCON 21



FALCON 7

**RECHARGES:**  
RECHARGE | RECARGA | RICARICA | LÄDT AUF



LAPTOP (<40W) | TABLET | SMARTPHONE | SAT PHONE | GPS | ACTION CAMERA | SLR CAMERA | SMARTWATCH | HEAD TORCH

# Prestigio

[www.prestigio.com](http://www.prestigio.com)

## Graphene Powerbanks

GRAPHENE PD  
10000 mAh

GRAPHENE PD PRO  
20000 mAh



CHARGE SEVERAL DEVICES SIMULTANEOUSLY



WIRELESS CHARGING WITH QI CERTIFICATION

The wireless charging feature makes Graphene PD Pro compatible with any devices that support the Qi standard. You don't need any cables to charge the battery, simply place your device over the portable power bank.

EUROPE'S FIRST EVER GRAPHENE POWER BANK

The Graphene PD Pro external power bank is set apart by its use of the most forward-thinking technology on the market: it is graphene-based, meaning that the battery will not overheat even during rapid charging and the device will exceed that of traditional external power banks threefold.

GRAPHENE PD AND GRAPHENE PD PRO  
CHARGES 3.5 TIMES FASTER

No more waiting the whole night for the power bank to charge.

CHARGER  
60W



# Promate

## MagSafe Power-Banks

- Transparent Design
- MagSafe Charging
- Multi-Device Charging
- USB-C input
- Airfree.



# Promate

## PD-20 POWER PACK

**20Watts POWER DELIVERY**

**Qualcomm Quick Charge 3.0**

**PowerPack-PD20**

USB-C  
Lightning

US

EU

UK

**Included**

Simplify your on-the-go charging experience with this versatile 15000mAh power bank. Forget the bulk of carrying extra cables as PowerPack-PD20 features USB-C and Lightning Connector cables and the AC input lets you charge the power bank quickly through the AC socket. Amazing charging compatibility in a portable package.

**USB-C Power Delivery**

USB-C 20W Power Delivery

**Built in kick stand** | Extend into a Stand for Your Devices

**20W Power Delivery**

High Speed Charging

**Battery Capacity 15000mAh**

**Compact Size**

**Simultaneously charge up to 4 devices**

 **Built-In Cables:** Forget the bulk of carrying extra cables as PowerPack-PD20 features USB-C and Lightning Connector cables

 **Universal Compatibility:** PowerPack-PD20 is compatible with all USB-powered devices.

 **Automatic Voltage Regulation:** PowerPack-PD20 features Automatic Voltage regulation that offers the optimum charge to your connected device

 **Charge 4 Devices:** Simultaneously charge up to 4 devices through the ports and built in cables

 **AC/DC Charging Input:** Charge quickly and easily through the AC socket or via the USB-C input

 **Safe & Reliable:** PowerPack-PD20 features short-circuit & over-charging protection that keeps all your connected devices protected



# Promate

## TITAN 30 POWER PACK



**PROMATE**  
Innovation and Excellence

### Titan-30

### 30000mAh

### High Capacity Power Pack

**18 Watts**  
Power Delivery

Qualcomm  
Quick Charge 3.0

USB-C<sup>™</sup>  
Input/Output

**PREMIUM QUALITY**  
**2 YEARS WARRANTY**

**12X** PHONE CHARGES  
**6X** TABLET CHARGES  
**12X** ANDROID CHARGES

**TITAN 30**

### FAST RECHARGING

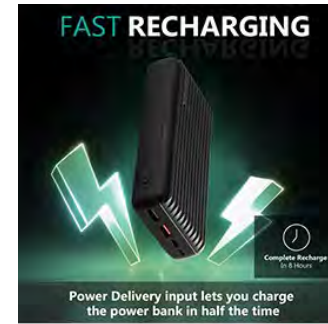

Power Delivery input lets you charge the power bank in half the time

### ULTRA FAST USB PORTS



- 18W Power Delivery Input/Output
- Quick Charge 3.0 Port
- 12.4A

Promate Intellicharge

### QUICK CHARGE TECHNOLOGY

Charging up 85% in 30 mins

Qualcomm Quick Charge 3.0 port offers 4X charging speed than a standard charger



### ULTRA-FAST POWER DELIVERY OUTPUT

Experience super fast charging with 18W PD USB-C port than standard chargers



# Promate

## AURA WATCH



### Ultra-Compact 6700mAh Power Pack for Apple Watch & iPhone

Apple MFi Certified • USB Charging Port • Built-In Lightning Connector



AuraWatch is not just a 6700mAh portable powerbank, the built in wireless charger provides a boost of power to your Apple Watch when on the go, while you can charge your iPhone via the built-in cable with Lightning Connector. Charge any other USB device via the 1A USB charging port on AuraWatch, making this powerbank the perfect companion to charge all your devices, anywhere on the move.

- Automatic Voltage Regulation
- Over-Charging Protection
- Over-Heating Protection
- Ultra-Portable
- Universal Compatibility

#### Specifications

- Battery Capacity: 6700mAh
- Battery Type: Lithium Ion
- Input: 5V, 2A
- Output: - USB Output: 5V, 1A  
- Lightning Connector Output: 5V, 1A  
- Wireless Charger: 5V, 1A
- Charging Time: 4.5 hours
- Wireless Charging Distance: 3-5mm

#### Available Colors



COMPATIBILITY	PACKAGING CONTENT	AVAILABLE COLOR	CERTIFICATION
Smartphones supporting charging USB and Lightning Connector, Apple Watch	AuraWatch Charging Cable UserGuide	Silver Black	CE RoHS FC



# Sandberg

<https://www.sandberg.world/>

## Outdoor Powerbanks



Outdoor Solar Powerbank 10000

420-53



Outdoor Solar Powerbank 16000

420-35



Outdoor Solar Powerbank 24000

420-38



Survivor Powerbank 20100

420-36



Solar 4-Panel Powerbank 25000



Solar Charger 13W 2xUSB



Solar Charger 21W 2xUSB+USB-C



Sport Armband LED 4.7"



Survivor CamperPowerbank 42000



Survivor Powerbank 10000



Survivor Powerbank 30000 PD45W



Survivor Torch Powerbank 10400

# Scosche

[www.scosche.com](http://www.scosche.com)

## Wireless BT-Speaker / Bottle opener

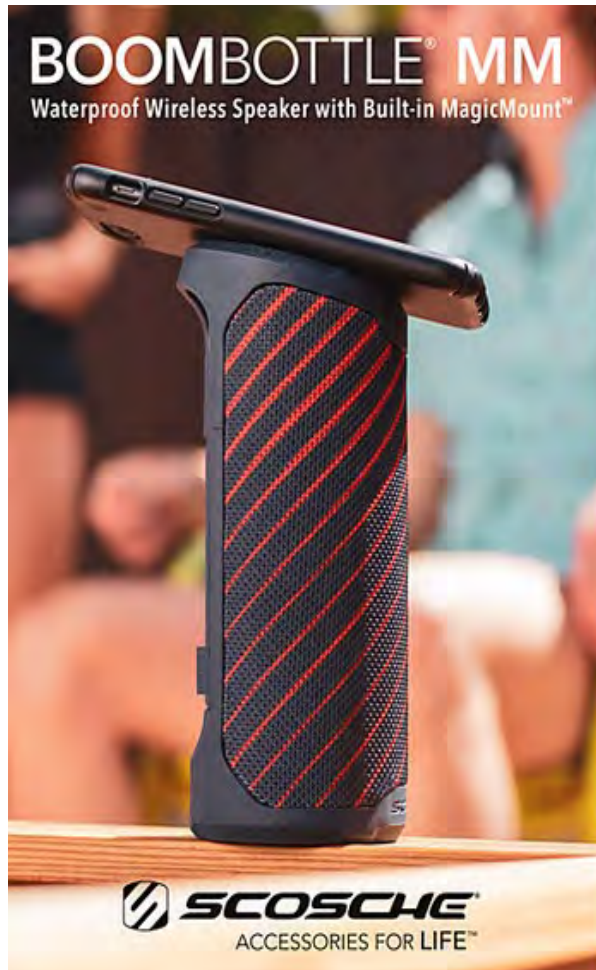

# Xtorm

## PORTABLE POWER-BANKS



OUTDOOR & SPORT

# August

## BLUETOOTH WINTER CAPS



Bluetooth Wintermützen mit integrierten Kopfhörern und Mikrofon.  
Tasten zur Steuerung von Musik, Lautstärke und Anrufen.  
Eingebauter Akku für bis zu 2 Stunden Musikgenuss.  
Wärmeisolierung für coole Tunes auf warmen Ohren.



# Bivvy Loo

<https://www.youtube.com>

## PORTABLE TOILET



**Passender Deckel** für die Bivvy Loo besonders nützlich, wenn die Toilette länger aufgebaut bleibt, z. B. auf dem Campingplatz



**Bivvy Loo Camping-Toilette**  
+ 40 biologisch abbaubare Wischtücher  
+ 12 biologisch abbaubare Innenbeutel  
+ 12 Einheiten Absorberpulver



### Nachfüllpack

- 40 biologisch abbaubare Wischtücher
- 12 biologisch abbaubare Innenbeutel
- 12 Einheiten Absorberpulver



# Bushcraft

## ECO-FRIENDLY COOKING FUEL



1 Litre



250 ml



27 g



cooker

- Non-toxic and odourless when burnt
- Easy and quick to ignite - use the flint, match or lighter.
- Low luminosity
- Very little soot given off, so doesn't dirty your cooking pot
- Easy to store and handle
- Safe to be packed with food
- High calorific value 29,000 (kj/kg)
- Potential for use as a hand sanitizer.
- Each block will burn for about 8 minutes.
- Suitable for all weather conditions
- Will light & burn even when wet
- Can be used with a variety of cookers
- Made from sustainable, natural biofuel
- Air transportable
- Patented



# Bushcraft

## FIRST AID KITS FOR SMALL AND LARGE TOURS



FIRST AID  
ON THE MOVE



# Bushcraft

[www.bcb.in.com](http://www.bcb.in.com)

## WINTER EMERGENCY KITS



### CONTENTS:

cooking tin • fire dragon fuel blocks x 2  
emergency sleeping bag • led torch  
folding cooker • distress whistle • button compass  
nightlight • poncho with hood • hypothermia blanket  
mini grip bag • matches • antiseptic wipes  
drinking pouch (400ml) • karabiner



### CONTENTS:

- Hypothermia Space Blanket
- 2 x 12 hour Green Lightsticks
- Loud distress whistle
- High Energy Bar (CHERRY)
- Large Fleece Blanket 120 x 150 cm
- A Pair of long lasting Hand Warmers
- UNICOM SQUEEZE TORCH



### CONTENTS:

- foil blanket
- 8-hour lightsticks
- howler whistle
- large wind-up torch
- Fleece blanket
- handwarmers
- energy bar

# Bushcraft

[www.bcb.in.com](http://www.bcb.in.com)

## ADVENTURE KITS

### FESTIVAL SURVIVAL TIN

**FEATURING:**  
 GLOW IN THE DARK WHISTLE//  
 //TOOTHBRUSH//  
 //MINI WORK TOOL//  
 //FOLDING SPORK//  
 //FOIL PONCHOS//  
 //EARPLUGS//  
 //TEABAG

WWW.BCBADVENTURE.COM

### Travel Survival Tin

**CONTENTS INCLUDE:**  
 INSECT REPELLENT STICK (40% DEET),  
 LED MICRO TORCH,  
 COMBINATION PADLOCK,  
 COIN TOWELS X2,  
 CAN OPENER,  
 FOLDING TOOTHBRUSH,  
 COFFEE AND SUGAR SACHET,  
 BARLEY SUGAR

WWW.BCBADVENTURE.COM

### THE B.E.S.T TIN

BACKPACKERS' ESSENTIAL SURVIVAL TIN

**BACKPACKERS' ESSENTIAL SURVIVAL TIN**  
 CONTENTS INCLUDE:  
 INSECT REPELLENT STICK  
 LED MINI TORCH  
 MINI WORK TOOL  
 FOLDING TOOTHBRUSH  
 COIN TOWELS  
 WATER PURIFICATION TABLETS  
 PADLOCK  
 FIRST AID KIT  
 PLASTIC SPOON  
 SAFETY SUGAR

WWW.BCBADVENTURE.COM

### MY FIRST ADVENTURE KIT

FOR EVERYONE'S SAFETY

TAKE PART IN YOUR FIRST ADVENTURE,  
 STEP AWAY FROM TECHNOLOGY AND  
 EXPLORE THE OUTSIDE, EVEN IF IT'S ONLY  
 IN YOUR BACK GARDEN.

WWW.BCBADVENTURE.COM

### My Dog Walking Handy Tin

**Contents include:**  
 1 Emergency dog lead in case yours breaks or is lost.  
 2 A super bright LED torch for the night time.  
 3 An extremely loud whistle to call for your dog.  
 4 Doggy bags so you're never caught out.  
 5 The tweezers are great also to remove any nasty thorns or ticks with.  
 6 Antiseptic wipes to help avoid any infections.  
 7 Waterproof sterile plasters for minor cuts & grazes.

WWW.BCBADVENTURE.COM

### HANGOVER RELIEF TIN

**INSIDE:**  
 COFFEE SACHET  
 MINT CAKE  
 PLASTERS  
 EAR PLUGS

**BARLEY SUGAR  
 TOOTHBRUSH  
 TWEEZERS  
 SICK BAG**

WWW.BCBADVENTURE.COM

### Fishing Survival TIN

**CONTENTS INCLUDE:**  
 FISHING ROD AND REEL  
 BLANKET  
 FIRST AID KIT AND STRIKER - WITH COMPASS,  
 MINI FISHING KIT,  
 WATER PURIFICATION TABLETS,  
 BARLEY SUGAR SACHET,  
 MINI WHISTLE,  
 TEALIGHT CANDLE

WWW.BCBADVENTURE.COM

### Golf Survival TIN

**Includes:**  
 Energy Sweet,  
 Small Pencil,  
 Handwarmer,  
 Vaseline,  
 Sun Cream,  
 Go Wipes Coin Towels,  
 Plasters,  
 Golfing Tees

WWW.BCBADVENTURE.COM

# Bushcraft

## LIFESAVER FIRST AID KITS

### Lifesaver #6 First Aid Kit



- Contents:
- Triangular bandage 90 x 127cm
  - No.8 medium dressing
  - No.2 ambulance dressing
  - Cotton gauze swabs
  - Extra large dressing No. 3
  - Elastic adhesive bandage 7.5cm x 4.5m
  - Paraffin gauze 10x10cm
  - First aid scissors
  - PE gloves
  - Burn bag
  - Assorted waterproof plasters
  - Zinc oxide tape
  - Lifesaver instruction leaflet
  - Pouch Size: 26 x 14 x 7cm
  - Made in Britain



### Elite Explorer's Kit



Elite Explorer's Kit - 32 Piece Kit the ultimate survival kit for the elite explorer! Jam packed with tools, medical, fire lighting and emergency signalling items. All packed inside our large vibrant red 500D nylon pouch with a waterproof resistant zip to keep your gear protected, which has an easy to find, hi visibility pull-tab. The new pouch opens up to multiple foldout compartments which are clear view for ease of browsing your desired kit! Carry handle on top and two belt loops on the rear. Clear pouch on the rear below the belt loops for quick easy access to survival/emergency instructions.

### Prepper's Pack



The Prepper's Survival Pack - 21 piece kit containing essential Prepper's Survival items - all packed inside our large, vibrant red, 500D nylon pouch with a waterproof resistant zip to keep your gear protected, which has an easy to find, hi visibility pull-tab.

The new pouch opens up to multiple foldout compartments which are clear view for ease of browsing your desired kit! Carry handle on top and two belt loops on the rear. Clear pouch on the rear below the belt loops for quick easy access to survival/emergency instructions.

### Hunter's Grab Bag



Hunter's Grab Bag - 20 Piece Kit - contains handy accessories designed to Grab'n/Go for hunters. Various kit to assist with noting, signalling in emergency situations & fire lighting.

All packed inside our compact, vibrant red, 500D nylon durable pouch with a waterproof resistant zip to keep your gear protected, which has an easy to find, hi visibility pull-tab.

### Travel Bag



Travel Bag - 14 piece kit grab and go on your adventure with the pre-packed travel essentials bag. All packed inside our large vibrant red 500D nylon pouch with a waterproof resistant zip to keep your gear protected, which has an easy to find, hi visibility pull-tab.

The new pouch opens to multiple foldout compartments which are clear view for ease of browsing your desired kit! Carry handle on top and two belt loops on the rear. Clear pouch on the rear below the belt loops for quick easy access.

# Bübi Bottle

[www.bubibottle.com](http://www.bubibottle.com)

- Roll up for easy storage
- Great for lunch packs, freeze night before.
- Easy to clean from the inside or in the dishwasher
- Stealthy, makes no noise
- Place over a fire to boil water
- Use as hot or cold compress
- Clip carabiner to backpacks or purses
- Microwavable safe\*
- BPA-Free, microbial free silicone material
- Store your valuables to keep dry
- Puncture-proof, will not break when dropped
- Also able to drink underwater when using the sport cap
  - \*Microwavable safe once carabiner is removed

# bübi

**Available in 2 sizes:**



14oz/415mL    22oz/650mL  
1000ml coming soon



**Comes in 8 different colors:**



# Bübi Bottle

[www.bubibottle.com](http://www.bubibottle.com)

## bübi *award-winning* **scrunchable** *multi-use bottle*



### features

- microwave-\* and freezer-safe
- mold-resistant
- bpa-free
- never releases harmful chemicals
- retains its shape
- dishwasher-safe
- lightweight
- foldable
- reversible to clean
- customizable
- great for gifting
- \*remove cap and carabiner before placing in microwave

### versatile

- hot or cold beverages
- hot or cold compress
- hot or cold pillow
- stress relief
- arthritis pain relief
- warming bed, hands, ski boots
- ice or hot pack
- hydration

### storage

- laundry detergent
- cleaning products
- dry or liquid medicine
- milk, juice, breastmilk
- dry goods like rice, oatmeal, tea
- matches
- bandages
- waterproofing electronics

### use everywhere

- hiking & outdoor sports
- at the beach or pool
- scuba diving
- water sports
- canoeing, camping, sailing
- toddlers and kids



# Coolado

[www.coolado.com](http://www.coolado.com)

## Two-Cylinder Mini Pump

- In just 12 seconds, you can inflate a bicycle tire from 0 to 3 bar
- Suitable for all SUV, Minibus, Camper, Caravan, Car, Motorbike, Bicycle, sport balls

....

Schrader Valve



Presta Valve



Plastic Nozzle



Ball Needle



### 5 Universal Valves

Every tire is different and requires a unique valve. With these five adapters, you are ready to go:

- ✓ Air tube with Schröder adapter for bike, motorcycle, car, caravan and camper
- ✓ Adapter for Presta (or French) and Dunlop (or Dutch) valve
- ✓ tClamp with air release button
- ✓ Pin needle adapter for sportballs
- ✓ Inflatables adapter



### The smart tire pump for intuitive, everyday use

With tire pressures up to 100 PSI or 6,9 BAR, the versatile tPump can handle just about any tire need. The digital LCD display shows pressure readings so you may accurately measure and set the correct tire pressure

- ✓ Have all types of tires inflated for you without effort
- ✓ Check tire pressure at home or on the road
- ✓ A semi professional tool

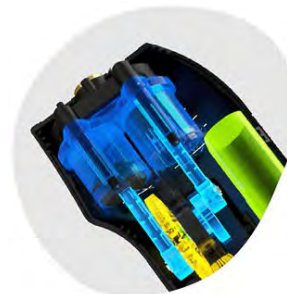

Two-cylinder engine with a powerful motor



# Coolado

[www.coolado.com/](http://www.coolado.com/)

Model X

# coolado

## Portable Tire Inflator tPump Model X

The tPump Model X is a high-quality portable air compressor that's suitable for all types of tires. With an inflation pressure of up to 10.3 BAR or 150 PSI, the tPump can handle all your inflation needs. The digital LCD touch screen provides pressure information so you can accurately measure and set the right tire pressure.



For Bike, Motorbikes, Cars & Sport Balls

## LCD Touch Screen & Metal Body

The tPump Model X is a portable high-pressure pump that can inflate all kinds of tires. With an inflation pressure of up to 150 PSI or 10.3 BAR. The tPump is perfectly suitable for all bikes, motorcycles, cars, and sports balls. The metal unibody provides a robust and premium design with longevity in mind.



Light & Compact



Cordless & USB-C



LCD Touch Display



Accessories  
4 Nozzles



2600 mAh Battery



Inflate Fast with Pressure

## Four Universal Valves

Every tire is different and requires a unique valve. With these four valves, you'll be set and ready to go: Schrader valve, Presta valve, plastic nozzle, and a sports needle. The tPump Model X comes with all valves included.

How many tires can the tPump inflate on one charge?



x6



x7



x9



x44

## FITNESS BANDS

DENVER  
denver-electronics.com

# FITNESS



### BFH-16 HIGHLIGHTS

- Fitnessband
- Colour display
- Bluetooth 4.0
- Heartrate sensor
- Blood pressure sensor
- Tracks your steps & sleep
- Shows caller ID and SMS notification



### SW-160 HIGHLIGHTS

- Smartwatch
- Bluetooth
- Heartrate sensor
- Tracks your steps & sleep
- Shows caller ID and SMS notification

### SW-170 HIGHLIGHTS

- Smartwatch
- Bluetooth
- Heartrate sensor
- Tracks your steps & sleep
- Shows caller ID and SMS notification



### BFH-250 HIGHLIGHTS

- Fitnessband
- Colour display
- Bluetooth 4.0
- Heartrate sensor
- Tracks your steps & sleep,
- Shows caller ID and SMS notificationn

# Floë

[keepfloeing.com](http://keepfloeing.com)

## CARAVAN & CAMPER DRAINAGE KIT



Wenn Sie einen Wohnwagen oder ein Wohnmobil mit einem nicht abschaltbaren Wasserspeicher an Bord haben, dann ist dies das Combo-Kit für Ihre Bedürfnisse.

Gewinner des Practical Caravan's Caravan Accessory of the Year 2012, unser Floë System ist eine einfache Möglichkeit, Ihren Wohnwagen oder Camper zu entleeren, um Platz für herrlich frisches Trinkwasser zu schaffen, oder als Vorbereitung für die kalten Winterfröste.

Floë wurde von der University of Ulster getestet und hat wissenschaftlich bewiesen, dass es mehr als 99,9 % des abgestandenen Wassers, der Bakterien und des Biofilms entfernt, so dass Ihr System frisch und leer für jede Reise ist (siehe Frischwasser-Floë). Es hat sich auch bei Winterfrost bewährt, um die komplizierten Komponenten Ihres Wassersystems wie Ihre Pumpe, den Wasserfilter, die Dusche und die Kunststoffarmaturen zu schützen (siehe Better Cash Floë).

Mit seiner patentierten Technologie schnappen und klicken Sie dieses Floë-Kit einfach neben Ihren Frischwassertank und mit Hilfe einer Fußpumpe oder eines 12-Volt-Reifencompressors können Sie das Wasser aus jedem Wasserhahn und jeder Armatur herausspülen und wissen so, dass Ihr System leer ist.

# Frendo

## VINTAGE BAGS

### VINTAGE



# Frendo

## Backpacks

AERO backpacks (tensed net back)



SAINTE BAUME backpacks (many accessories)



WATERPROOF backpacks (waterproof)



# Frendo

## RECHARGEABLE AND BATTERY-OPERATED LANTERNS

**AMBI'LIGHT-R**

ANSI - FL1 48 LUMENS	ANSI - FL1 6h10min	ANSI - FL1 6,5 m
----------------------------	-----------------------	---------------------

**AMBI'LIGHT +**

ANSI - FL1 25 LUMENS	ANSI - FL1 10 h
ANSI - FL1 7 LUMENS	ANSI - FL1 20 h

# Glowstone

## Flashlight

- Small
- Bright
- Versatile



Glowstone Flashlight Essential Pack

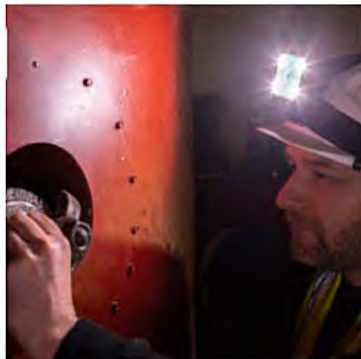

Glowstone Flashlight Professional Pack

**Glowstone™**

The World's Most Versatile Flashlight

60 hour battery life  
Incredibly Bright

A blue Glowstone flashlight with a grid of 180 small LEDs and a central circular logo. The flashlight is shown from a slightly elevated angle against a dark blue background.

## Accessories

What good is a flashlight if it's not practical for the job at hand? We've designed Glowstone Flashlight to be adaptable to your needs, interests and hobbies. It works with multiple attachments and mounts to be the perfect companion, whether you're a keen photographer, a DIY enthusiast or an outdoor explorer.



**Glowstone 4-in-1 handle**  
Our Glowstone handle is specially engineered to have multiple functions and uniquely transforms to suit your needs.



**Nano-suction technology**  
Uniquely, the flashlight can easily stick and unstick to most flat surfaces using our nano-suction pad. Without adhesive.



**Head-strap**  
With the flashlight's 180 degrees light spread, the head strap provides non-directional hands-free lighting. Simply attach to the head strap and turn night



**Belt clip**  
Hands-free lighting is a must when doing a hands-on job.



# Heat Holders

[www.heatholders.co.uk](http://www.heatholders.co.uk)

## THERMO SOCKS



**Mehr als 7 mal wärmer als ein basic Baumwolle Socke!**

<b>Heat Holders®</b>	<b>2.34</b>	
<b>Normale thermal Socke</b>	<b>0.89</b>	
<b>Basic Baumwolle Socke</b>	<b>0.33</b>	



Herren- und Damen ORIGINAL	Herren- und Damen GESTREIFT	Herren- und Damen ABS-SOHL	Herren- und Damen EXTRALANG	Damen FÜR GUMMISTIEFEL	Herren- und Damen SKI SOCKEN	Herren UNTERWÄSCHE	Damen STRUMPFHOSEN UND LEGGINGS	Damen Mützen und Handschuhe	Herren Mützen und Handschuhe
<ul style="list-style-type: none"> <li>• Fortschrittliches isolierendes Garn</li> <li>• Angenehm längere Innenfütter</li> <li>• Weichgeknüpfte Innenfütter</li> <li>• Klassischer Sockenrand</li> <li>• Streifen-Design</li> </ul>	<ul style="list-style-type: none"> <li>• Fortschrittliches isolierendes Garn</li> <li>• Langgestrichelter Thermofleece</li> <li>• Weichgeknüpfte Innenfütter</li> <li>• Klassischer Sockenrand</li> <li>• Streifen-Design</li> </ul>	<ul style="list-style-type: none"> <li>• Fortschrittliches isolierendes Garn</li> <li>• Langgestrichelter Thermofleece</li> <li>• Weichgeknüpfte Innenfütter</li> <li>• Klassischer Sockenrand</li> <li>• Halbhöhe</li> <li>• Elastischer Sockenrand</li> <li>• Heißer Support</li> </ul>	<ul style="list-style-type: none"> <li>• Fortschrittliches isolierendes Garn</li> <li>• Langgestrichelter Thermofleece</li> <li>• Weichgeknüpfte Innenfütter</li> <li>• Elastischer Sockenrand</li> <li>• Große Länge</li> </ul>	<ul style="list-style-type: none"> <li>• Fortschrittliches isolierendes Garn</li> <li>• Langgestrichelter Thermofleece</li> <li>• Weichgeknüpfte Innenfütter</li> <li>• Elastischer Sockenrand</li> <li>• Heißer Support</li> <li>• Große Länge</li> </ul>	<ul style="list-style-type: none"> <li>• Fortschrittliches isolierendes Garn</li> <li>• Langgestrichelter Thermofleece</li> <li>• Weichgeknüpfte Innenfütter</li> <li>• Elastischer Sockenrand</li> <li>• Heißer Support</li> <li>• Große Länge</li> </ul>	<ul style="list-style-type: none"> <li>• Gerippt</li> <li>• Nachhaltiger Body</li> <li>• Weichgeknüpfte Innenfütter</li> <li>• Baumwollmischung</li> <li>• Klassischer Sockenrand</li> <li>• Langarm-Weißer</li> <li>• Langarm-Weißer</li> </ul>	<ul style="list-style-type: none"> <li>• Fortschrittliches isolierendes Garn</li> <li>• Weichgeknüpfte Innenfütter</li> <li>• Klassischer Sockenrand</li> <li>• Heißer Support</li> </ul>	<ul style="list-style-type: none"> <li>• Fortschrittliches isolierendes Garn</li> <li>• Weichgeknüpfte Innenfütter</li> <li>• Klassischer Sockenrand</li> <li>• Heißer Support</li> </ul>	<ul style="list-style-type: none"> <li>• Fortschrittliches isolierendes Garn</li> <li>• Weichgeknüpfte Innenfütter</li> <li>• Klassischer Sockenrand</li> <li>• Heißer Support</li> </ul>





# Heat Holders

[www.heatholders.co.uk](http://www.heatholders.co.uk)

## CAPS & ABRASION SOCKS



# Heat Holders

## LICENSE SOCKS FOR ADULT AND CHILDREN



# Heat Holders

## CHRISTMAS SOCKS

### MENS HEAT HOLDERS CHRISTMAS SOCKS 6-11 • TOG RATING 2.3



### LADIES HEAT HOLDERS CHRISTMAS SOCKS 6-11 • TOG RATING 2.3



### HEAT HOLDERS LITE CHRISTMAS SOCKS 4-8 • TOG RATING 1.6



DON'T JUST TAKE OUR WORD OF WARMTH...

TOG (Thermal Overall Grade) is an independent laboratory tested standard. The higher the TOG rating, the better a product is able to keep you warm.

- OVER 15 MILLION PAIRS SOLD WORLDWIDE
- OVER 7X WARMER THAN A BASIC COTTON SOCK

We have never tested another thermal sock with a higher TOG rating than Heat Holders.

# HidrateSpark

[www.hidratespark.com](http://www.hidratespark.com)

Smart Water Bottle + App

Solution: Smart Water Bottle + App "Blink, Drink, Sync"



HidrateSpark Steel



- Vacuum insulated stainless steel. 24 hrs cold
- New & improved sensing accuracy (not exposed to water)
- Customizable glow colors
- Extensible sensor platform
- Rechargeable battery
- Straw & chug lid offerings
- 17 oz & 21 oz
- 4.3 stars on Amazon

**Blink**      **Drink**      **Sync**

- **Patent Application No:** 62/840,476
- **Load cell technology**, which measures minute stresses in an aluminum bar, to precisely measure the weight of the bottle and its contents.
- **Bluetooth Low Energy** communication transmits data and receives instructions from iOS and Android devices.
- **Accelerometer** detects bottle orientation to ensure accuracy. Weight measurements are only taken when the bottle is set on a flat surface upright and is still for several seconds.
- **10 full-RGB LEDs** create vibrant glow patterns that remind users to drink water, provide information about battery life, and more.
- **Internal clock** with wake and sleep-time settings ensure days are accurately tracked and glows occur at appropriate times.
- **Internal memory** on the sensor stores up to three days of drinking history if phone connection is interrupted.
- **Rechargeable Li-ion battery** provides 10 -14 days of use on a single charge (Magnetic USB charging cable included).
- **Sturdy**, high-engineered design withstands drops, hits and bangs.
- **Find My Bottle**, phone remembers the last synced location and shows a pin on the map.

**HidrateSpark Steel**      **Sensor**      **Bottle + Sensor**

# Highlander

[www.highlander-outdoor.com](http://www.highlander-outdoor.com)

## Outdoor Water filter

- Effective against 99.9% of protozoa, bacteria and viruses
- Environmentally friendly as one filter cleans up to 1000L of water
- Turns dirty water into drinking water immediately



# Lenovo

## Smart Watches

**LENOVO E1PRO**  
**MAKE GOOD TIMES BETTER**



**BLUTDRUCK & BLUTSAUERSTOFF MONITORING**  
 24 Std. HERZ- & SCHLAF-MONITORING  
 1,4" / 3,6cm FULL TOUCH HD SCREEN  
 3 ATM / IPX68 WASSERDICHT



### Lenovo E1 Pro Sport Smartwatch

#### Blutdruck und Sauerstoffsättigung

2 spezielle Funktionen zur Überwachung Ihrer Gesundheit mit genauer Analyse weiterer Körperparameter

**BLUTDRUCK & BLUTSAUERSTOFF MONITORING**



Lenovo R1  
**Global 1st**  
**DIY**



**Lenovo**

**Lenovo R1 SMART WATCH**

**Multi-strap to choose**  
 1.3" big colored screen with Full touch  
 7H toughened glass lenses  
 24H continue heart rate monitor  
 IP68 Waterproof  
 Normal use time 7-10days  
 Standby time for 30days

Screen type:	TFT
Screen size:	1.3" all touch screen
CPU:	Nordic 52832
Bluetooth version:	Bluetooth 4.0
Waterproof:	IP68 WaterProof
RAM:	64KB
ROM:	512KB
Battery capacity:	280mAh
Battery type:	Lithium Polymer Battery
Using time:	7-10 days
Charging time:	About 2-3hours
Standby time:	30 days
Strap material:	Silicone/ Steel strap
Strap colour:	black/ Black + Green/ Black Milanese
Case colour:	black
Compatibility:	Android 4.4 and iOS 8.0 and above
Functions:	Alert type, Smart reminder, Health tracker, Message
Retail box size:	16'16'3cm
Product weight:	0,231kg



# Mpowerd

[www.mpowerd.com](http://www.mpowerd.com)

## LUCI PRO



### LUCI PRO SERIES

Doppelte Akkukapazität  
Doppelte Helligkeit  
Die neue Luci Pro Serie bringt  
Sie weiter als je zuvor.

MPOWERD™



With a warm, natural glow, the Luci Lux Pro Series effortlessly combines versatility, durability and elegant design to make every adventure epic.

OFF GRID ADVENTURES  
CAMPING · HIKING · BOATING  
CLIMBING · KAYAKING

### LUCI® LUX PRO



- Frosted Finish
- Durchmesser: 12,7 cm
- Höhe: 10,2 cm aufgeblasenem 3,8 cm zusammengeklappt
- Gewicht: 156 g
- Inklusive Zwei-Wege-1A-USB-Anschluss
- Beinhaltet 1m USB zu USB Kabel
- 4 Modi: niedrig, mittel, hoch, 1 Sek. blinken
- 10 warmweiße LEDs, 150 Lumen
- 2000 mAh 5 V Lithium-Polymer-Akku
- hält bis zu 50 Stunden
- lädt in 14 Stunden durch direkte Sonneneinstrahlung
- lädt in 2-3 Stunden über USB auf
- laden Sie ein Smartphone 30-50% in 2-3 Stunden auf
- 4 LED Batteriestandsanzeige
- Wasserdicht: IP67-Einstufung
- Betriebstemperatur: -10°C - 50°C
- Überladungs- und Überladungsschutz
- Überstrom- und Kurzschlusschutz



Our toughest and longest lasting light yet, test your limits with the Luci Pro Series.

OFF GRID ADVENTURES  
CAMPING · HIKING · BOATING  
CLIMBING · KAYAKING

### LUCI® OUTDOOR 2.0 PRO



- Clear Finish
- Durchmesser: 12,7 cm
- Höhe: 10,2 cm aufgeblasenem 3,8 cm zusammengeklappt
- Gewicht: 156 g
- Inklusive Zwei-Wege-1A-USB-Anschluss
- Beinhaltet 1m USB zu USB Kabel
- 4 Modi: niedrig, mittel, hoch, 1 Sek. blinken
- 10 warmweiße LEDs, 150 Lumen
- 2000 mAh 5 V Lithium-Polymer-Akku
- hält bis zu 50 Stunden
- lädt in 14 Stunden durch direkte Sonneneinstrahlung
- lädt in 2-3 Stunden über USB auf
- laden Sie ein Smartphone 30-50% in 2-3 Stunden auf
- 4 LED Batteriestandsanzeige
- Wasserdicht: IP67-Einstufung
- Betriebstemperatur: -10°C - 50°C
- Überladungs- und Überladungsschutz
- Überstrom- und Kurzschlusschutz



# Mpowerd

[www.mpowerd.com](http://www.mpowerd.com)

## INFLATABLE SOLAR LIGHT



The go-anywhere do-anything light



### LUCII SPECIFICATIONS

#### Lucii® Color Color-changing inflatable solar light

10.8 cm height | 12.7 cm diameter | 2.5 cm collapsed

- 8 unique colors plus color cycling mode (red, green, blue, purple, yellow, cyan, orange, white)
- Fringed glittery finish
- No batteries needed, just the sun
- Battery charge indicator
- 1 year warranty



### SPECIFICATIONS

#### Lucii® Original Inflatable Solar Light

10.8 cm height | 12.7 cm diameter | 2.5 cm collapsed

- Lantern & flashlight
- Lightweight, durable & waterproof
- No batteries needed, just the sun
- Battery charge indicator
- 1 year warranty



#### Lucii® EMRG 3-in-1 Inflatable Solar Light

10.2 cm height | 10.2 cm diameter | 3.2 cm collapsed

- Lantern, flashlight, and emergency light
- SOS Morse code
- Lasts up to 10 years
- No batteries needed, just the sun
- 1 year warranty



#### Lucii® Outdoor Inflatable Solar Light

10.8 cm height | 12.7 cm diameter | 2.5 cm coll.

- Dual straps (top & bottom)
- Lightweight, durable & waterproof
- No batteries needed, just the sun
- Battery charge indicator
- 1 year warranty



#### Lucii® Lux Inflatable Solar Light

10.8 cm height | 12.7 cm diameter | 2.5 cm coll.

- Warm LED
- Fringed finish
- No batteries needed, just the sun
- Battery charge indicator
- 1 year warranty





# Mpowerd

[www.mpowerd.com](http://www.mpowerd.com)

## STRING LIGHTS

Luci SOLAR STRING LIGHTS



### Specifications:

- Patent Pending
- Battery: 3.7V 2000 mAh Lithium-ion Polymer battery (5V PCB)
- Solar Panel: High-efficiency solar panel
- Charge time: 2-3 hours via USB; 12-14 hours via solar panel
- Four light modes to choose from:
  - Front LED
  - String LEDs on low, up to 20 hours (15 lumens)
  - String LEDs on medium, up to 10 hours (50 lumens)
  - String LEDs on high, up to 5 hours (100 lumens)



### Product functions:

- 4 modes: low, medium, high, external flashlight
- 2 second quick shut off
- Battery level indicator

### Charge:

- Lasts up to 20 hours on a single charge
- Recharge via solar or quick-charge with USB (16 hours / 6-8 hours)
- Rechargeable 2000 mAh Li-ion battery
- Overcharge and over discharge protection
- Overcurrent and short circuit protection



### We've put the sun on a string.

Hidden inside the expandable unit, Luci Solar String Lights pack 100 lumens into 10 nodes on an 18ft/5,5m cord. Along with mobile charging capabilities, this is the perfect way to light up your space.

# Mr. Heater

[www.mrheater.com](http://www.mrheater.com)

The World's Most Popular Brand of Indoor Heaters



**LITTLE Buddy**



**Mr. Heater**

**Portable Buddy**



# Mr. Heater

[www.mrheater.com](http://www.mrheater.com)

The World's Most Popular Brand of Indoor Heaters



Mr. Heater



# Overboard

www.overboard.com

PROTECTS WHAT'S INSIDE BEFORE THE WATER FROM THE OUTSIDE



iPad COMPATIBLE



iPad mini COMPATIBLE



iPhone 7 COMPATIBLE



iPhone 7 Plus COMPATIBLE



## DRY BAGS

NEW



2

Waterproof Dry Pouch Multipack - 1 Litre



2

Waterproof Dry Pouch - 1 Litre



2

Waterproof Dry Pouch - 1 Litre



20 LITRES

30 LITRES

45 LITRES



NEW



2

Waterproof Dry Pouch - 1 Litre



3

Dry Bag Multipack Divider Set 3L + 6L + 8L



3

Dry Bag Multipack Divider Set - 20L + 20L



30 LITRES



NEW



3

Waterproof Waist Pack - 3 Litres



3

Waterproof Carbon Waist Pack - 3 Litres



3

Waterproof SLR Camera Bag



NEW

NEW

3

Ultra-Light Waterproof Duffel - 50 Litres

3

Ultra-Light Waterproof Duffel - 50 Litres

3

Waterproof Duffel Bag - 60 Litres



NEW



3

Waterproof Front Wheel Bike Pannier Set - 24 Litres



3

Waterproof Back Wheel Bike Pannier Set - 32 Litres



3

Waterproof Full Bike Pannier Set - 62 Litres

# Platinet

[www.platinet.eu](http://www.platinet.eu)

FLIEGENKLATSCHER

## MOSQUITO KILLER BAT

LED Lamp Function & Battery

### Electric mosquito trap

The lamp is equipped with a practical insecticide system (mosquitoes and other night insects work), which consists in passing current through a metal mesh that is part of the device. This tension is effective for insects and safe for humans.

### TECHNICAL SPECIFICATIONS

- Battery: 1200 mAh, lithium battery, type 18650
- Charger: DC 4.2V 500 mA (not included)
- Charging time: 4 hours
- Portable, powered by a built-in battery
- Charging with universal USB connector
- No noise and no harm
- High efficiency
- LED lamp function



LED LIGHT



BUILD-IN BATTERY



ULTRA-QUIET



ELECTRIC SHOCK

PRMB3839



2 in 1  
OUTDOOR  
RECHARGABLE



# Runlock

[www.runlock.se](http://www.runlock.se)

## THE INTELLIGENT ROPE



**RunLock®**

RunLock besteht aus zwei parallel laufenden Seilen, die verflochten sind, so dass sie regelmässige Schlaufen bilden. RunLock ist ein schwedisches Produkt von bester Qualität, hergestellt aus 100 % Polyester, verfügbar in sechs unterschiedlichen Grössen. Das Seil ist dehnbar und reisst nicht bei ruckartiger Belastung. RunLock muss nicht gespleisst oder verknotet werden und behält dafür in allen Situationen seine Stärke. Dank der genialen Konstruktion gibt es kein Verrutschen der Knoten, sie sind nie schwer zu öffnen, unabhängig von der Belastung. An jeder beliebigen Stelle am Seil kann eine lockere Schlinge, eine feste Schlinge oder ein Schnellverschluss gemacht werden - alle gleich leicht zu lösen und zu verschieben. RunLock bietet unbegrenzte Möglichkeiten und Verwendungsbereiche, nur die Phantasie des Benutzers setzt Grenzen.



# Schröter

[www.schroeter.de](http://www.schroeter.de)

## ELEKTRONISCHE FLIEGENKLATSCHER

**OHNE CHEMISCHE GIFTSTOFFE**  
**EINFACHE UND SICHERE ANWENDUNG**  
**SAUBER - SCHNELL - WIRKUNGSVOLL**  
DIE EFFEKTIVE ALTERNATIVE FÜR DIE  
BESEITIGUNG STÖRENDER INSEKTEN



# Scosche

[www.scosche.com](http://www.scosche.com)

## WATERPROOF ARMBAND HEART RATE MONITOR

### RHYTHM24™

Waterproof Armband Heart Rate Monitor



**RHYTHM 24**  
PerformTek with higher efficiency

- Features:**
- IP68 (Waterproof)
  - 24 Hour battery life
  - LED Battery Indicator
  - On Board Memory (ANT+ FIT file transfer)
  - NFC-A Tag
  - 5 Heart Rate Zones Indicators

**Connection Profiles**

- Bluetooth Smart
- ANT+

**Modes:**

- Heart Rate Variability Mode (R-R Interval)
- Stride Based Speed & Distance (ANT+)
- Running Speed & Cadence (Bluetooth Smart)
- Cycling Cadence (ANT+)
- Cycling Cadence (Bluetooth Smart)
- Updated Heart Rate Profile (ANT+)
- Swimming: Running, Cycling & Gym Mode Support



Works with Most Popular Fitness Apps

Connects With:

Universal Platform



Bluetooth SMART Devices



ANT+ Devices



Integrates With Countless Apps



Works with over 200+ fitness apps

**Must Haves**

- 24HR Battery Life
- Better visibility during the day
- Heart rate
- Heart rate variability
- Cycling cadence
- Step rate/running cadence
- Updated form factor
- IP68 (10m)
- Bluetooth Smart & Ant+
- On board memory, ant+ FS - fit profile
- 5-Color LED hear zone indicator
- 3-LED mouse-style battery strength indicator
- Bike cadence
- Step count

**Future Development**

- Temp sensor (with new ANT+ chip)
- Music controls monitor (place holder for further discussion)
- Muscle oxygen monitor
- Lactate Threshold/ Lactic Acid Level Monitor
- Blood pressure monitor
- Polar fitness assessment compatible

RHYTHM24





# Solar Technology

[www.solartechology.co.uk](http://www.solartechology.co.uk)

## SOLAR CHARGERS AND UNIVERSAL POWER SUPPLIES



**UNIVERSAL  
CAMERA CHARGER**  
Also **EIN** Ladegerät  
für **ALLE** Akkus!



# Stormsure

## REPAIR KITS



- S1B**
- Reparaturkleber
  - Inhalt: 15 Gramm
  - wasserdicht
  - Verwendbar für: Kleidung, Schuhe, Camping, Gartenmöbel, Holz, Keramikprodukte, Luftmatratze
  - abriebfest



- S3x5**
- Reparaturkleber
  - Inhalt: 3 x 5 Gramm
  - wasserdicht
  - Verwendbar für: Kleidung, Schuhe, Camping, Gartenmöbel, Holz, Keramikprodukte, Luftmatratze
  - abriebfest



- S3x5BK**
- Schwarzer Reparaturkleber
  - Inhalt: 3 x 5 Gramm
  - wasserdicht
  - Verwendbar für: Kleidung, Schuhe, Camping, Gartenmöbel, Holz, Keramikprodukte, Luftmatratze
  - abriebfest
  - für schwarze Flächen



- OPROOF 250**
- Imprägnierspray
  - Inhalt: 250 ml
  - ideal für Textilien und Schuhe geeignet



- TUFF 1.0**
- Klebeband
  - Länge: 1 Meter
  - Breite: 7,5cm
  - wasserdicht
  - geeignet für wasserdichte Kleidung, Kunststoff, Löcher in Stoffen wie Leder oder Nylon



- OSEAL**
- Wasserbasierte Naht-Dichtungsflüssigkeit
  - Inhalt: 100 ml
  - ideal für kleine Löcher, z.B. in Zelten oder Luftmatratzen



- ZIP 8A**
- Ersatz-Reißverschluss-Zipper
  - für 7-8mm breite Reißverschlüsse
  - Inhalt: 10 Stück
  - Ideal für Kleidung, Schuhe, Tauchanzüge, Zelte



- RKBOXTENT**
- Reparaturset für Zelte
  - Set bestehend aus:
    - 15g Stormsure Reparaturkleber
    - 1 Tuff Tape Streifen (50 x 7,5cm)
    - 1 Tuff Tape Circular Band (7,5cm)
    - 1 Paar Ein-Weg-Handschuhe
    - Alkohol



- RKBOXWATER**
- Reparaturset für Wassersportgeräte wie Luftmatratzen, Schlauchboote
  - Set bestehend aus:
    - 2x 5g Stormsure Reparaturkleber
    - 1 Tuff Tape Streifen (50 x 7,5cm)
    - Auswahl an versch. Tuff-Patches
    - Spreizspatel, 1 x Handschuhe



- RKROOF**
- Reparaturset für Cabrios, PVC oder Leinwände
  - Set bestehend aus:
    - 5g Stormsure Reparaturkleber
    - 2x Tuff Bandstreifen (15 x 3cm)
    - 2 Tuff Tape Patches (7,5cm)
    - Anleitung



- RKSAIL**
- Reparaturset für Segler, Kite-Surfer
  - Set bestehend aus:
    - 5g Stormsure Reparaturkleber
    - 2x Tuff Bandstreifen (15 x 3cm)
    - 2 Tuff Tape Patches (7,5cm)
    - Anleitung



- NQB**
- Neopren Wetsuit Reparaturset
  - Set bestehend aus:
    - 30g Neopren-Kleber
    - 5 kreisförmige Neoprenflecken in unterschiedlicher Größen
  - ideal für Surfer, Angler, Body Boarder, Segler

# Talon

## PIVOT CHAIR

**TALON PIVOT CHAIR**

**360° SWIVEL**

**ALL-IN-ONE**  
Integrated Frame Set

Technical patented in the USA and Korea  
Now on application for patents in Germany, Japan, Russia  
China and so on

**DURALUMIN 7001**



### LIGHT SWIVEL PIVOT CHAIR - SHORT

**360° SWIVEL**

**ALL in only 2.6 Lbs / 1200 g**



**S SHORT**

**SPECIFICATIONS**

**Materials** Fabric: Polyester 100% with PU coating & Water-repellent treatment  
Frame: Duralumin 7001 (Aluminum Alloy)

**Size(cm)** Fold-in) 11 x 11 x 32 Cm  
Fold-out) 48 x 50 x 74 Cm

**Weight** 1200g (except pouch bag)

**Load Capacity** 150 Kg (Suggested)  
210 Kg (Max)



### LIGHT SWIVEL PIVOT CHAIR - LONG



**TALON PIVOT CHAIR**



**360° SWIVEL**

**ALL in only 3.0 Lbs / 1400g**

### ULTRA LIGHT SWIVEL PIVOT STOOL - MINI

**360° SWIVEL**



**ALL in only 0.9 Lbs / 450 g**



# Texenergy

[www.texenergy.com](http://www.texenergy.com)

## OUTDOOR POWER

### INFINITE ORBIT

POWER GENERATING  
HAND CRANK  
INSTANT POWER 24/7.

The Infinite Orbit hand crank generates instant power direct to a device or battery. It is the ultimate survival tool for emergency situations. Perfect for charging smartphones, iPhones, GPS, satphones, headlamps and more.



#### SPECIFICATIONS

- Weight: 330g
- Dimensions: 150mm x 100mm x 45mm (with crank handle in position)
- Input: Human powered
- Output: 5V at 2 amps at steady speed
- Material: Aluminium case and crank handle
- Power generated: 10 Watts
- Gearing system: 32:1 sun and planet gears
- Operating temp: -40°C to +40°C
- Waterproof protection: IP65
- Warranty: Lifetime guarantee

#### FEATURES

- Lightweight, compact, efficient and durable
- Functions in extreme temperatures
- Compatible with USB chargeable devices
- IP65 rated: dust and splashproof

### INFINITE AIR

PORTABLE WIND TURBINE  
HARNESS THE WIND  
TO GENERATE POWER.

The Infinite Air harnesses the wind to generate instant power direct to a device or battery. Perfect for charging smartphones, iPhones, GPS, SLR cameras, medical equipment and more.



#### FEATURES

- Lightweight, compact efficient and durable
- Functions in extreme temperatures
- Compatible with USB chargeable devices
- Auto on/off sensing technology
- Universal camera mount attachment point
- Compact collapsing tripod with universal camera mount
- Anchor holes in tripod legs for securing with pegs or cord
- IP65 rated – dust and splashproof

#### SPECIFICATIONS

- Weight: 429g
- Dimensions:
  - Approx 200 x 140 x 80mm (in case)
  - Blade/turbine diameter when constructed 320mm
  - Max tripod height 380mm / Collapsed tripod 200mm
- Input: Wind power
- Output: 5V at 1.5-2 amps
- Material: Turbine housing aluminium/blades PP
- Power generated: 7.5 to 10 Watts in winds as light as 15mph
- Operating temp: - 20°C to + 40°C
- Waterproof protection: IP65
- Warranty: 2 Years



### TEX-FLEX RANGE

FLEXIBLE, WEARABLE,  
PORTABLE POWER

Texenergy have designed a range of flexible, wearable batteries that not only mould to your body/equipment but are also extremely lightweight, waterproof, durable, magnetic and capable of working at extreme temperatures.

RECHARGEABLE BATTERY  
LIGHT, FLEXIBLE  
AND WATERPROOF

### TEX-FLEX 3



### TEX-FLEX 3C



### TEX-FLEX 10



## TOWN BAGS



UMWATERBAG



WATER RESISTANT

IDEAL FOR :



UMPOCKETBAG

FOLDABLE BACKPACK



COMPACT  
Faible encombrement



LIGHT  
Léger



BPTRAVEL



SAC À DOS

## FITNESS TRACKER

### T-FIT 220 PLUS

HEALTH TRACKER

HEART RATE NOTIFICHE DA SOCIAL APP BIG DISPLAY A COLORI  
BLOOD PRESSURE BLOOD OXYGEN IP 67



### T-FIT 290 HBT

SMART TRACKER

TEMPERATURE 24h HEART RATE FULL TOUCH SCREEN ULTRA BRIGHT DISPLAY  
PPG BLOOD PRESSURE IP 67 METAL BODY 7 DAYS WORKING TIME



### T-FIT 260 PLUS

SMART TRACKER

ALWAYS ON 1.7" IPS ULTRA BRIGHT TEMPERATURE HEART RATE BLOOD PRESSURE  
BLOOD OXYGEN IP 68 SWIMMING METAL BODY 7 DAYS WORKING TIME



### T-FIT 320 GPS

SMART GPS TRACKER

GPS INSIDE HEART RATE SOCIAL APP NOTIFY FULL TOUCH SCREEN BRIGHT DISPLAY  
IP 68 SWIMMING METAL BODY 7 DAYS WORKING TIME



# Trevi

[www.trevi.it](http://www.trevi.it)

## Wireless Mic EM408R



The microphones wireless set contains:

- Receiver for universal connection Jack 6.3mm
- Transmitter with volume control and Jack 3.5 mm socket
- Microphone arch connectable in to transmitter
- Microphone clip connectable in to transmitter
- It allows to use the arch or clip microphone artenatively
- Frequencies band VHF / 174MHz - 216MHz
- Distance: until to 20m
- Power transmitter and receiver: 2x1,5V (type "AA") not included
- Dimension transmitter: 95 x 66 x 20 mm
- Dimension transmitter: 80 x 32 x 25 mm
- EU restrictions countries: UK, ES, FR, DK, MT, IE

# Walkstool

[www.walkstool.com](http://www.walkstool.com)

## COMPACT TELESCOPIC STOOL



- Two sitting positions

One with legs extended and one with legs retracted. Perfect when resting or working in low positions.

- Light weight

Aluminum construction.

- Compact & portable

Featuring telescopic legs and a practical carrying bag.

- Durable

High quality and load capacity. Made and invented in Sweden.

- Comfortable

Ergonomic with large breathable seats.

- Widely usable

From outdoor activities to professional users.

- Unique

telescopic legs, patents and trademark protections.

- Big rubber feet

For stability on softer surfaces.





# Wenger

## LUGGAGE

[www.wenger.ch](http://www.wenger.ch)

**WENGER**



### CityPatrol

Rolling 16" Laptop Backpack with Tablet Pocket

- Protective wheel cover and hideaway trolley handle
- RFID protection pocket
- Triple Protect padded compartment protects up to a 16" laptop
- Air-flow back padding keeps wearer cool

34w x 48h x 25d cm | 13.4"w x 18.9"h x 9.8"d  
2.71 kg | 5.97 lbs 24 | 1465 cu in



### Ero

16" Laptop Backpack with Tablet Pocket

- Padded 16" laptop compartment and dedicated tablet pocket
- Interior mesh accessories pocket
- Comfort-fit shoulder straps
- Mesh side pockets

30w x 44h x 15d cm | 11.8"w x 17.3"h x 5.9"d  
0.67 kg | 1.48 lbs 22 | 1343 cu in



### Priam

16" Laptop Backpack with Tablet Pocket

- Water-repellent exterior
- Comfort-fit shoulder straps
- CaseBase stabilizing platform keeps bag standing upright

33w x 44h x 25d cm | 13.0"w x 17.3"h x 9.8"d  
1.12 kg | 2.46 lbs 24 | 1464 cu in



### CityGo

16" Laptop Backpack with Tablet Pocket

- Quick Pocket for easy access to essentials
- RFID protection pocket
- Triple Protect padded compartment protects up to a 16" laptop

31w x 46h x 26d cm | 12.2"w x 18.1"h x 10.2"d  
0.90 kg | 1.98 lbs 23 | 1404 cu in



### Arundel

16" Laptop Backpack with Tablet Pocket

- Quick Pocket for easy access to essentials
- Essentials organizer with anti-scratch lining
- Triple Protect padded compartment protects up to a 16" laptop
- Air-flow back padding keeps wearer cool

32w x 44h x 25d cm | 12.8"w x 17.3"h x 9.8"d  
1.08 kg | 2.38 lbs 23 | 1404 cu in



### SunScraper

Double Flap Over 16" Laptop Business Case with Tablet Pocket

- Quick Pocket for easy access to essentials
- RFID protection pocket
- Triple Protect padded compartment protects up to a 16" laptop / Lockable zippers

48w x 30h x 18d cm | 18.9"w x 11.8"h x 7.1"d  
0.78 kg | 1.72 lbs 16 | 976 cu in



### WindBridge

16" Laptop Business Case with Tablet Pocket

- Quick Pocket for easy access to essentials
- Essentials organizer
- Padded compartment for up to a 16" laptop

43w x 15h x 25d cm | 17.0"w x 6.0"h x 11.5"d  
0.99 kg | 2.18 lbs 16.8 | 1147 cu in



### Mandria

Convertible 16" Laptop Backpack/Business Case with Tablet Pocket

- Triple Protect padded compartment protects up to a 16" laptop
- Quick Pocket for easy access to essentials
- Essentials organizer with anti-scratch lining

32w x 42h x 23d cm | 12.8"w x 16.5"h x 9.1"d  
1.06 kg | 2.33 lbs 22 | 1342 cu in

# Wenger

[www.wenger.ch](http://www.wenger.ch)

## LUGGAGE FOR BUSINESS TRAVELLER



### LUMEN BUSINESS

**Product Description** Expandable Hardside Luggage, 20" Dual Access  
**Product Category** Luggage  
**Article Number** Black 604345  
**EAN Code** Black 7613329050293

**Product Dimensions** 21w x 55h x 40d cm / 15.2" w x 21.7" h x 8.9" d  
**Product Weight** 3.2 kg / 7.05 lbs  
**Product Volume** 36 l / 2196 cu in  
**Color** Black  
**Material** 100 % PC (+10% pure / 30% recycle)  
**Carton Quantity** 1

- Key Benefits**
- Tru-fit packing system provides easy loading and unloading of your belongings
  - Built-in ID tray for name and address if the luggage is lost
  - 2 zippered interior pockets offer outstanding organization
  - Compression straps stabilize your belongings
  - Three dial combination lock on main compartment keeps your belongings safe

**Product Features**



### MATRIX 20

**Product Description** Expandable Hardside Luggage, 20" Carry-On  
**Product Category** Luggage  
**Article Number** 604352  
**EAN Code** 7613329050361  
**Product Dimensions** 40w x 55h x 20d cm / 15.2" w x 22.1" h x 7.8" d  
 Expands to 23.5d cm / 9.3" d  
**Product Weight** 2.8 kg / 6.2 lbs  
**Product Volume** 32 l / 1952 cu in  
**Product Volume** Expands to 38 l / 2318 cu in  
**Color** Black  
**Material** 100 % PC (+10% pure / 30% recycle)

- Key Benefits**
- Built-in ID tray for name and address if the luggage is lost
  - 2 zippered interior pockets offer outstanding organization
  - Removable laundry bag for dirty clothes
  - Compression straps stabilize your belongings
  - Three dial combination lock on main compartment keeps your belongings safe
  - Tru-fit packing system provides easy loading and unloading of your belongings

**Product Features**



### SYNERGY 20

**Product Description** Expandable Softside Dual Access 20" Carry-On Luggage  
**Product Category** Luggage  
**Article Number** 604377  
**EAN Code** 7613329050644  
**Product Dimensions** 40w x 55h x 20d cm / 15.4" w x 22" h x 7.8" d  
 Expands to 23d cm / 9" d  
**Product Weight** 2.85 kg / 6.27 lbs  
**Product Volume** 41.5 l / 2541 cu in  
 Expands to 48.4 l / 3218 cu in  
**Color** Black/Grey  
**Material** 100 % Polyester  
**Carton Quantity** 1

- Key Benefits**
- Padded laptop compartment for up to a 15.6" laptop with tablet pocket.
  - Fabric wrapped haul handle makes lifting easy and comfortable
  - Built-in ID tray to place Name and Address if the luggage gets lost
  - 2 zippered interior pockets offers an outstanding organization
  - Compression straps stabilizes your belongings
  - Lightweight aluminium trolley handle with 3 height adjustments
  - Three dial combination lock on main compartment keeps your belongings safe

**Product Features**



### IBEX

**Product Description** 125<sup>th</sup> Anniversary Ballistic 17" Backpack with tablet pocket  
**Product Category** 125<sup>th</sup> anniversary product  
**Article Number** 605501  
**EAN Code** 7613329060520  
**Product Dimensions** 37w x 47h x 28d cm / 14.6" w x 18.5" h x 11.0" d  
**Product Weight** 1.68 kg / 3.70 lbs  
**Product Volume** 26 l / 1587 cu in  
**Color** Black  
**Material** Polyester  
**Carton Quantity** 3 pieces

**Key Benefits**

- CaseBase stabilizing platform keeps bag standing upright
- Air-flow back padding keeps wearer cool
- Shock-absorbing shoulder straps

**Product Features**



## LUGGAGE FOR BUSINESS TRAVELLER



Artikel: 600662  
 Bezeichnung: Wenger PATRIOT  
 Notebookgröße: bis 12.5 bis 17.3" Zoll  
 EAN: 7613329008201  
 Abmessung: 43 x 37 x 26 cm  
 Gewicht: 4.85 kg  
 Volumen: 38 Liter  
 Farbe: schwarz  
 Material: hoch strapazierbares Polyester

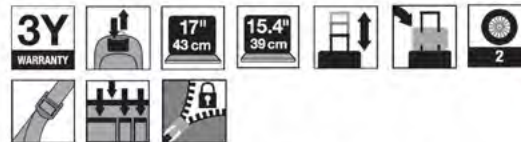

1. Stabiler und genieteter Tragegriff.
2. Großes Frontfach für Smartphone, Schlüssel, Visitenkarten, Stifte, kleines Zubehör und Dokumente.
3. Großzügiges und abschließbares Notebookfach für 17.3" inkl. separate 15.6" Notebooktasche.
4. Wechselbare Rollen.
5. Bodenplattenstabilisierung und Kantenschutz inkl. Standfuß.
6. Je zwei Zipperpuller an den Hauptfächern.
7. Leichtlauf Trolleygestänge, Gesamthöhe des Trolleygestänges 105 cm.
8. Trolley Band.
9. Schnelfach für z.B. Tickets.
10. Hinteres Fach für z.B. Kleider.



# ZAP-IT

[www.zap-it.info](http://www.zap-it.info)

## MOSQUITO BITE RELIEF

***Ouch!!!***

only one stitch  
then it hurts shortly  
then itches it very long.

**Unless you have  
ZAP-IT with you**

With ZAP-IT  
you stop the itching.



- Place ZapIt directly on top of the mosquito bite
- Press the button quickly 5 times
- After a few minutes the itching will ease
- No batteries needed



In 6 different colours!



E-MOBILITY

## E-Bikes



### bomber

The free spirit "Muscle Bike". It's foldable and can be carried everywhere, making the riding experience unique. Snow, sand, ground, asphalt... nothing can stop it. The "wow" effect for those who don't want to go unnoticed.

-  POWER  
250 W
-  6 SPEED CONTROLS  
25 KM/H MAX SPEED
-  FOLDABLE  
ALUMINIUM FRAME
-  FRONT  
SUSPENSION
-  MULTIFUNCTION  
LCD DISPLAY
-  LED  
LIGHT
-  10Ah  
BATTERY
-  FAT 20"  
TYRES
-  FRONT AND REAR  
DISC BRAKE



### Bomber F20 F

- Aluminium frame
- Foldable
- Front disk brake
- Rear disk brake
- 20" tyre
- 6 speeds Shimano derailleurs
- Multifunction LCD display
- 36V 10Ah frame integrated battery
- About 40 km max range
- 250W Motor power
- 25Km/h max speed
- 5 power assisted levels
- Front and rear LED lights
- Rear luggage rack
- Mechanical bell
- 150Kg max load capacity

Available in colours:

F20F01 - 8011000026428 ○ / F20F00 - EAN 8011000026411 ● / F20F03 - EAN 8011000026732 ●

## E-Bikes

### jammy

With its strong steel frame and ease-of-use, Jammy is the ideal bike for every city-rider: whether it's a ride, shopping or just a moment of freedom to experience the soft touch of the wind on you.

-  250 W POWER
-  6 SPEED CONTROLS  
25 KM/H MAX SPEED
-  26" TYRES
-  LED LIGHT
-  10AH BATTERY



#### jammy CY26









- Steel frame
- V Brake
- 6 speeds Shimano derailleurs
- 26" tyre
- LED Display
- 36V 10Ah horizontal rear battery
- About 50 km max range
- 250W Motor power
- 25Km/h max speed
- 3 Power assisted levels
- Front and rear LED lights
- Integrated padlock
- Rear luggage rack
- Mechanical bell
- 120Kg max load capacity

Available in colours: CY2601 - EAN 8011000026367  / CY2600 - EAN 8011000026374



### queen 28L

The maxi e-bikes suitable for everyone. Integrated battery, aluminium frame, front suspension, double disc brake, LCD display... the 28" wheel and the large frame offer a more comfortable pedaling.

-  250 W POWER
-  6 SPEED CONTROLS  
25 KM/H MAX SPEED
-  ALUMINIUM FRAME
-  FRONT SUSPENSION
-  MULTIFUNCTION LCD DISPLAY
-  LED LIGHT
-  10AH BATTERY
-  28" TYRES
-  FRONT AND REAR DISC BRAKE



#### Queen 28L CY28 ABI

- 19" Aluminium frame
- Front disc brake
- Rear disc brake
- Front suspension
- 28" tyre
- 6 speeds Shimano derailleurs
- Multifunction LCD display
- 36V 10Ah frame integrated battery
- About 60 km max range
- 250W Motor power
- 25K m/h max speed
- 5 power assisted levels
- Front and rear LED lights
- Rear luggage rack
- Mechanical bell
- 150Kg max load capacity

Available in colours: CY28LAB101 - EAN 8011000026695  / CY28LAB110 - EAN 8011000026725



# TnB, Urban prime

## E-Scooter Zubehör



URBAN MOOV

Rotary smartphone holder for bike/e-scooter



URBAN MOOV

Touch screen gloves with fleece warm lining



URBAN MOOV

Bell for bike/e-scooter



URBAN MOOV

Backpack reflective cover



URBAN MOOV

Pack of 36 reflective stickers



URBAN MOOV

Reflective jacket



URBAN MOOV

U-lock for bike/e-scooter



URBAN MOOV

Foldable segment lock for bike



URBAN MOOV

Frame lock for bike



Helmet foldable

Caschetto richiudibile, brevettato, per bici e monopattini

Per sicurezza in caso di collisione perché l'impatto viene dissipato in modo ottimale grazie al suo ampio movimento, che si distribuiscono su tutta la superficie. Occupa poco spazio perché richiude le sue dimensioni del 50% in pochissimo tempo. Ha il miglior rapporto qualità/prezzo qualunque borsa o zaino.



con Certificazione TÜV  
 codice prodotto: DUC-HLM-FOLD  
 codice EAN: 802270475242  
 codice prodotto: DUC-HLM-FOLD  
 codice EAN: 802270475242



E-scooter Bag

Borsa porta oggetti semplice e resistente

Fixaggio al manubrio del monopattino. Con sperone assicurante all'acqua. Profilo ribaltante per facilitare lo stoccaggio e la velocità di uscita.

codice prodotto: DUC-MOV-BAG  
 codice EAN: 802270475242





# Hammer

[www.hammer-international.de](http://www.hammer-international.de)

## E-Mofa K1 mit Strassenzulassung



	K1+
Motor (bürstenlos)	350 Watt
Akku	48V, 420WH, 8,7 Ah Li-Ion 48V, 504WH, 10,5 Ah Li-Ion optional
Räder	12,5 Zoll
Rahmen	Aluminium
max. Geschw.	20* / 25 / 30 km/h
max. Reichweite	30 - 40 km
max. Fahrergewicht	120 kg
max. Steigung	ca. 15°
Ladezeit	3 - 5 Stunden
Eigengewicht	18 kg
Farben	schwarz/weiß/weinrot/olivgrün/blue Jeans
Besonderheiten	Schnellwechsel-Akku, gesteigerte Leistung, integrierter Bluetooth-Lautsprecher, USB-Ladebuchse, Info-Display, Funkfernbedienung inklusive, wasserabweisend, Bremslicht, optional Transporttasche erhältlich



## BICYCLE ACCESSORIES



### LED BIKE LIGHT UMLED1

- Can be tightened to your handlebar and/or under your seat for you to see or to be seen while riding your bike / Scooter.
- 3 lighting modes are available : continuous + 2 blinking speeds.
- Water & dampness resistant for outdoor use
- This light includes 2 LEDs powered by CR2032 batteries (included).



### BIKE INDICATOR LIGHTS UMLED4

- Directional lights for bike.
- Indicator lights with tubular fixation system
- To be placed under your seat
- This product comes with 3 lighting modes:
  - Left lighting arrow : To inform you 're turning to the left
  - Right lighting arrow : To inform you 're turning to the right
  - SOS (CENTRAL RED LED BAR) to signal your position & inform that you have a problem.
- Comes with a remote controller to place on your bike's handlebar in order remotely & safely control the light signal while riding your bike.

### BIKE LIGHTS KIT UMLED2

- This kit is made up of 2 LED lights with handlebar fixation system.
- 1 Light is White for the front
- 1 Light is Red for the rear
- Both lights can work on continuous mode or blinking mode and are powered by LR03 - AAA batteries (not included).



### PHONE HOLDER FOR BIKE & SCOOTER UMBIKE2

You want to keep easy access to your Smartphone while you are cycling or motorcycling ? This handlebar holder is made for you. It must be fixed on the handlebar (max diameter 28mm) and thanks to its semi-rigid shell, it is protected from dust and water splash. Once closed, you can still access to your Smartphone thanks to the holder compatibility with tactile screens.



### 5-IN-1 BLUETOOTH SPEAKERS FOR BICYCLE UMHPBT51

This multifunction Bluetooth speaker is the perfect companion for all your travels. Equipped with a handlebar support, this speaker easily attaches to your bike. Connect the speaker to your smartphone in Bluetooth and listen to your music on the go. Equipped with the handsfree function, it also allows you to take calls without leaving your smartphone. This speaker also has the LED function to enlighten you during your night trips. Its built-in battery with a capacity of 1800mAh allows you to charge your Smartphone. Equipped with a micro SD card reader, this speaker will also allow you to listen to your music without a smartphone.



### SILICONE BIKE MOUNT UMBIKE1

You want to keep easy access to your Smartphone while you are cycling or motorcycling ? This handlebar holder is made for you. It must be fixed on the handlebar (max diameter 28mm).



# Trittbrett

[www.trittbrettoriginal.de](http://www.trittbrettoriginal.de)

## E-Scooter

- TÜV tested and with German road approval
- 30 - 35 km range thanks to high quality battery at 300 - 360 minutes charging time
- Foldable and easy to take along including cell phone holder



### **KALLE** DER SPORTLICHE E-SCOOTER

#### **Verbesserte Reichweite**

Kalle ist jetzt mit einem hochwertigen Hobbywing Controller ausgerüstet. Durch das optimale Zusammenspiel der Komponenten erreichen wir 20% mehr Reichweite als vorher. Bei unseren Tests mit 75 kg Fahrergewicht unter Vollgas wurde eine Reichweite von 30,6 km geschafft. Das entspricht der Reichweite, die wir mit dem 10.4 Ah Akku vorher erzielt haben.

#### **NEUES Licht**

Wir haben ein Upgrade auf die deutlich hellere Frontleuchte von PAUL vorgenommen. Die 30 Lux starke Lampe sorgt dafür, dass du bis zu 35 Meter beleuchtete Fahrbahn vor dir hast.

### **Trittbrett** DER E-SCOOTER

#### **Höhere Sicherheit**

Für größtmögliche Stabilität haben wir das Ver- schlussgelenk und die Form der Frontstange von PAUL auf Kalle übertragen und uns bei der Fertigung an Methoden aus Luft- und Raumfahrt bedient. Dadurch haben wir eine hohe Steifigkeit und ein verbessertes Gefühl beim Verschließen des Klappmechanismus erreicht.



#### **Feinfühligere Motorbremse**

Wir haben die on/off Motorbremse gegen die weiterentwickelte E-ABS Bremse von PAUL getauscht. Dadurch erreichen wir ein angenehmes Bremsverhalten bei voller Bremskraft.



FLASHLIGHTS

# Armytek

[www.armytek.com](http://www.armytek.com)

## FOR EVERY PURPOSE FLASHLIGHT

**BORN TO EXCEED**  
**ArmyTek®**



**MULTI-FLASHLIGHTS**  
10 in 1. Designed for your life.

No-Hassle  
**10 years**  
Warranty

**NEW** electronics, optics  
and construction!



- MULTI-FLASHLIGHT "10 IN 1"
- HEADLAMPS
- FOR FISHING



- FOR SHOTGUNS
- FOR RIFLED ARMS
- FOR HUNTING



- FLASHLIGHTS FOR TOURISM
- POCKET FLASHLIGHTS
- EDC FLASHLIGHTS

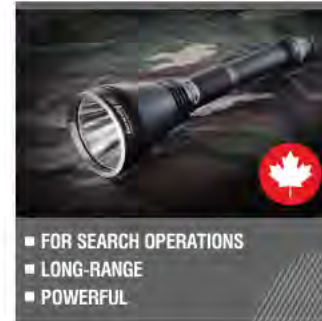

- FOR SEARCH OPERATIONS
- LONG-RANGE
- POWERFUL



### PERSONALLY FOR YOU

For many years we've been accumulating experience and thoroughly investigated the real requirements of the end customers who wanted to obtain a quality and reliable light. We speak about military officers and Special Forces, hunters and divers, rescuers and firemen, speleologists and bikers - all the enthusiastic and demanding people.

Now our product line consists of 32 models and 12 kinds of original accessories which are represented in 52 countries of the world, but in the nearest future 21 new models of flashlights will be released, which altogether will cover every significant sphere

### EXTREMELY ROBUST

We decided to implement in our products only the best LEDs and cutting-edge electronics made in Japan and the USA to obtain the revolutionary and unprecedented results.

You are able to throw almost all our flashlights from 10th-floor height and submerge them at 50 meters. Why? We've just put in such great margin of safety.

10 years no-hassle warranty.

We bust myths.

No more compromises.

Forget everything you've known about flashlights before.

### WHAT DISTINGUISHES US

Canadian manufacturer and own factory.

Designed especially for your needs.

The team of scientists and engineers engaged in military and space industry.

The best and tried-and-true components by the USA and Japan.

Particular attention to durability and technologies, not only to external design.

# Armytek

[www.armytek.com](http://www.armytek.com)

## FOR EVERY PURPOSE FLASHLIGHT

**Multi-flashlights**

**NEW** electronics, optics and construction

**No Hassle 10 years Warranty**

### Wizard PRO Magnet USB

**MULTI-FLASHLIGHT**  
Modes: 11 • Length: 110 mm • Head: 29 mm • Body: 24.5 mm • Weight: 65 g

**LED Cree XHP50**  
White or warm light

**2300 lumens**  
1x18650 Li-Ion (included, 3200 mAh)

**130 meters**

**What's included:**  
1 - clip  
2 - plastic holder  
3 - magnet USB charger  
4 - 2 spare O-rings  
5 - handband  
6 - 18650 Li-Ion battery  
7 - headband



**Multi-flashlights**

**NEW** electronics, optics and construction

**No Hassle 10 years Warranty**

### Tiara C1 PRO Magnet USB

**MULTI-FLASHLIGHT**  
Modes: 10 • Head: 29 mm • Body: 24.5 mm

**Cree XP-L LED**  
White or warm light

**1050 lumens • 106 meters**  
Length: 79 mm • Weight: 60 g  
1x18350 Li-Ion (included, 900 mAh)

**What's included:**  
1 - clip  
2 - plastic holder  
3 - 2 spare O-rings  
4 - headband  
5 - 18350 Li-Ion battery (900mAh)  
6 - magnet USB charger

**Superb light of amazing brightness** due to powerful electronics.

Rechargeable flashlight with magnet USB charger.

Efficient TIR-optics and no "tunnel vision" effect even after continuous use.

Multicolor State Indication and ultra low current drain in OFF-state – more than 25 years.

Multi-flashlight "10 in 1" for many activities: car, fishing, hunting, home, work, city, picnic, bike, outdoor, travel.

Total protection from water, dirt and dust penetration – flashlight continues to work even at the depth of 10 meters.



**Multi-flashlights**

**NEW** electronics, optics and construction

**No Hassle 10 years Warranty**

### Tiara C1 Magnet USB

**MULTI-FLASHLIGHT**  
Modes: 10 • Head: 29 mm • Body: 24.5 mm

**Cree XP-L LED**  
White or warm light

**1050 lumens • 106 meters**  
Length: 83 mm • Weight: 60 g  
1x18350 Li-Ion (included, 900 mAh)

**What's included:**  
1 - clip  
2 - plastic holder  
3 - 2 spare O-rings  
4 - headband  
5 - 18350 Li-Ion battery (900mAh)  
6 - magnet USB charger



**Chargers & Batteries**

**NEW** electronics, optics and construction

**No Hassle 10 years Warranty**

### Universal charger with power supply inside

**Armytek Uni C2 with Car adapter**

**with CAR ADAPTER**

**2100 lumens**  
1x18650 Li-Ion (included, 3200 mAh)

**192 meters**



**Every Day Carry Lights**

**NEW** electronics, optics and construction

**No Hassle 10 years Warranty**

### Prime C2 PRO Magnet USB

**BRIGHTEST FOR CITY**  
Modes: 11 • Length: 122 mm • Head: 24.5 mm • Body: 24.5 mm • Weight: 62 g

**LED Cree XHP35**  
White or warm light

**2100 lumens**  
1x18650 Li-Ion (included, 3200 mAh)

**192 meters**

**What's included:**  
1 - holster  
2 - clip  
3 - 2 spare O-rings  
4 - 1



## Taschenlampen

**Unverwüstliche Taschenlampe**

- Alu
- Strapazierfähiges Flugzeugaluminium
- 2m Stoßfestigkeit

**Aufladbar über USB und lange Betriebszeit**

- 40 Stunden Betriebszeit
- Mit Li-Ion 16650-Batterie im Lieferumfang
- Verblockschutz

**Einstellbar für breites Ausleuchten und Sicht in die Ferne**

Einstiche Öhrung: Um den Fokus von Punkt- auf Flutlicht zu ändern

**GP DISCOVERY**

### Ideales Notlicht im Taschenformat

**GP CK11**

12,6 mm x 37 mm

**Langlebige Taschenlampe**

- Alu
- Langlebiges Aluminiumgehäuse
- Rutschfester Körper
- 1m

11,5g

**IPX7 wasserdicht**

Witterungsbeständig

**GP**

Hochwertige LED-Technologie

1000

**Müheleise Lichtsteuerung**

Einstache Bedienung mit einer Hand

- Einknopf-Bedienung
- Rutschfeste Ritzelung
- Limbringebänd

**Leistungsstarkes Licht in einer kleinen Taschenlampe**

- 85
- Green LED
- 35m

**GP C31**

**Einfacher Ein-/Auswechsler**

Einfacher Lichtschalter

**GP DISCOVERY**

**C34**

**Kompaktes Leichtgewicht**

148 g

27mm x 193mm

ohne Batterien

**Unverwüstliche Arbeitslampe**

- Strapazierfähiges Flugzeugaluminium
- 1m Stoßfestigkeit
- IPX4 wasserdicht

**Müheleise Lichtsteuerung**

Einstache Bedienung mit einer Hand

- Einknopf-Bedienung
- Rutschfeste Ritzelung

**Langlebiges Licht für den Alltag**

- Alu
- 1m
- 64g

Langlebiges Aluminiumgehäuse

IPX 4

**Maximale Laufzeit 2 Stunden**

Bis zu 2Std

1 x AA Batterie

Akkubatterie enthalten

**GP**

85

85

**Freihändiger Komfort**

Taschenlampe

1-Mikroskop-Endleuchte

**4 Lichtstellungen für jede Situation**





















2 Haltepositionen:

- Seitliche COB-Lampe:
  - Hoch 850 lm
  - Niedrig 165 lm
- Vorderseitenlampe:
  - Hoch 350 lm
  - Niedrig 85 lm

\* Kompatibel mit sowohl Alkali-Batterien als auch mit wiederaufladbaren Batterien

# Mactronic

## PROFESSIONAL LIGHTS FOR EVERYBODY

 <b>NIPPO 1.8</b> AHL0012 D 08	 <b>NIPPO 1.9 RC</b> AHL0013 D 09	 <b>NIPPO 1.9 RCO</b> AHL1013 D 09	 <b>NIPPO 3.3 RC</b> AHL0014 D 09	 <b>PHOTON</b> AHL0011 D 10	 <b>SOLIS</b> ABS0011 D 27	 <b>WALLE</b> L-BPM-25L D 30	 <b>WALLE 2</b> L-BPM-65L D 30	 <b>RED EDGE</b> ABR0011 D 31	 <b>RED LINE</b> ABR0021 D 31	 <b>M-FORCE 2.1</b> THH0102 D 09
 <b>CAMO</b> AHL0015 D 10	 <b>PHANTOM</b> AHL0016 D 11	 <b>M-FORCE 630</b> THL0011 D 12	 <b>M-FORCE 550</b> L-MR-T550-HL D 13	 <b>M-FORCE 100</b> L-MR-T110-HL D 13	 <b>MILESTONE WIRELESS</b> L-BPM-08WL D 33	 <b>THUNDER XTR</b> L-LM001-HL/L2300-444C D 35	 <b>EVS 780</b> L-MR142L-RC, THH0042 D 36	 <b>EVS 420</b> L-MR322L-RC, THH0041 D 36	 <b>EVS MINI</b> L-MR512L D 37	 <b>MCT-GLAUBERTY</b> THH0151 D 15
 <b>NOMAD 02</b> THL0021 D 14	 <b>K5 MINI</b> L-HLS-1AGL-RHS D 15	 <b>ULTIMO</b> PHL0011 D 15	 <b>SHERPA</b> L-LT-400L D 17	 <b>RAMBLER</b> L-LT-250L D 17	 <b>NU TRAIL 02</b> PHH0041 D 37	 <b>Sniper</b> L-BPM-25L D 38	 <b>SNIPER 02</b> THH0011 D 38	 <b>X-PISTOL RC 02</b> PSL0021 D 39	 <b>ACCESSORIES</b> D 43	 <b>BLACK EYE 1300</b> THH0044 D 23
 <b>M-ZARD</b> ACL0011 D 18	 <b>WARLOCK</b> ACL0021 D 19	 <b>NOISE XTR 03</b> ABF0041 D 22	 <b>NOISE XTR 04</b> ABF0042 D 22	 <b>ROY.01</b> ABF0051 D 23	<b>Mactronic® &amp; Buck® Knives combination gift packs</b>					 <b>SNIPER 3.1</b> THH0041 D 29
 <b>ROY.02</b> ABF0032 D 23	 <b>STREET.01</b> L-AL-015F D 24	 <b>SCREAM</b> L-BPM170L D 25	 <b>SCREAM 02</b> ABF0051 D 25	 <b>Galaxy</b> L-BPM-2L1-3L D 27	 <b>RED NOISE SET</b> GPR0022 D 41	 <b>BLACK BANTAM SET</b> GPR0021 D 41	 <b>FORCE BACK SET</b> GPR0013 D 41	 <b>FLARE</b> L-F-12-AMBER D 79		
 <b>M-FIRE 03</b> PHH0012 D 36	 <b>M-FIRE 02</b> L-PL-011-01-4H D 37	 <b>M-FIRE AG</b> PHH0021 D 38	 <b>M-FIRE HL</b> PHL0021 D 39	 <b>DURA LIGHT 200</b> L-PL-001H D 40	 <b>DURA LIGHT 500</b> L-PL-002H D 41	 <b>M-FORCE 3.1</b> THH0103 D 10	 <b>DEFENDER 02</b> THH0121, THH0123 D 11	 <b>NIGHT HUNTER 02</b> THH0131, THH0132 D 12	 <b>UV BEAM</b> THH0141 D 13	 <b>POLARIS SYSTEM</b> PUL-P00011 D 86
 <b>DURA LIGHT 2.1</b> PHH0121 D 42	 <b>DURA LIGHT 2.2</b> PHH0122 D 43	 <b>DURA LIGHT 2.3</b> PHH0123 D 44	 <b>DURA TOOL</b> PHL0011 D 45	 <b>M-FLARE 4</b> P500011 D 45	 <b>NU TRAIL 02 UV</b> PHH0062 D 47	 <b>PATROL CHARGER+</b> THH0062 D 18	 <b>EXPLORER</b> L-MR322LR5-RC D 19	 <b>EXPERT 02</b> THH0021 D 20	 <b>EXPERT 03</b> THH0031 D 21	 <b>MONSTER LIGHT</b> PFL0041 D 95



# Olight

## Marauder Mini

- Dual-beam with flood and spot features a 600-meter round spotlight beam and a 7,000 lumens floodlight beam from 9 surrounding LEDs
- Uniformly distributed RGB LEDs
- Easy toggle switch
- 3D rotary knob
- Large battery capacity
- IPX8 waterproof

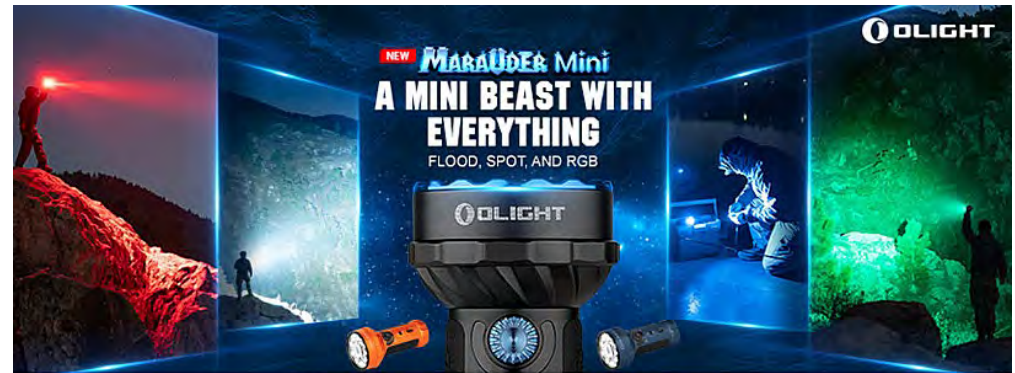

# Olight

## Imini

- Magnetic mini flashlight that turns on when pulled off
- Instant activation: To switch on, simply pull the housing off the magnetic cap.
- Hands-free operation: The tiny lamp features a magnetic base that allows it to be attached to metallic surfaces, making it "hands free"

**INSTANT ON/OFF**  
Quickly release the light when you need it in a hurry.

**SUPER MINI**  
Tiny size body weighs only 0.4oz, easily carry it wherever you go.

1.38in/3.5cm

**REPLACEABLE BUTTON CELLS**  
Powered by 3 LR41 button cells that you can easily replace.  
3 additional batteries are included.

**imini**  
**TINY, MAGNETIC AND INSTANT LIGHT**

**OLIGHT™**

 MAX OUTPUT <b>10 LUMENS</b>	 MAX RUNTIME <b>30 MINUTES</b>	 MAX THROW <b>10 METERS</b>
 BATTERY <b>3 LR41 BUTTON CELLS</b>	 DROP TEST <b>1.5 METERS</b>	 WATER RESISTANT <b>IPX6</b>

# Olight

[www.olightworld.com](http://www.olightworld.com)

## Marauder 2

**14,000 LUMENS** **800 METERS**

**NEW MARAUDER 2**  
**ADAPT AND CONQUER**  
 THROW · FLOOD · POWERBANK

BLUE BLACK

**SPECTACULAR DUAL BEAMS IN YOUR HAND**  
 14,000-lumen floodlight powered by 12 high-performance LEDs.  
 800-meter rectangular spotlight beam, the world's first.

**LARGE BATTERY AND REVOLUTIONARY TWO-WAY 30W CHARGING**  
 Three 3.6V 5000mAh batteries built-in. Fully charge in **2.5 hours** with a 30W adapter. As a power bank, charge your phone several times at a noticeably fast speed.

**SMART LOCKOUT AND UNLOCKING**  
 Gets locked out automatically after **30 seconds** of non-operation when the light is already off.  
 To unlock, rotate the knob switch over **90 degrees** quickly.

**SAFEST IN ITS CLASS**  
 The first turbine-like cooling fins for flashlight and the built-in thermal and proximity sensors keep the beast in check.

Cooling Fin  
 Thermal Sensor  
 Proximity Sensor

**IMPACT-PROOF, WATERPROOF, DUSTPROOF**  
 Durable aluminum alloy body that survives a **water drop**. **IP68** waterproof USB-C charging port shielded against dust by the port cover.

WATERPROOF  
**2 METERS**

**LIGHT SOURCE**  
 High Performance Cool White LEDs

**DIMENSIONS**  
 Length: 5.51in/140mm  
 Head Diameter: 3.11in/79mm  
 Body Diameter: 2.09in/53mm

**WEIGHT**  
 26.5oz/750g (Including Batteries)

**BODY MATERIAL**  
 Aluminum Alloy

**POWERED BY**  
 Customized Three 3.6V 5000mAh 21700 Rechargeable Lithium-Ion Batteries (Built-in)

**WARRANTY**  
 Olight's 5-Year Warranty  
 Visit: <https://olightworld.com/olight-warranty>

**INTUITIVE OPERATION AND INDICATORS**  
 Rotary knob to circle through 7 brightness levels and a simple indicator dashboard.

Brightness Level Indicator  
 Charging Status Indicator  
 Battery Level Indicator

Shake Bezel  
 Cooling Fin  
 Rotary Knob Switch  
 Toggle Switch  
 Hidden Lanyard Hole

USB-C Charging Port  
 Silicone Body Surface  
 Battery Level Indicator  
 Low Battery Indicator  
 Charging Status Indicator

Output Level Indicator

TIR Lens  
 Covering Lens

Dustproof Cover

USB-C Charging Cable

# Olight

[www.olightworld.com](http://www.olightworld.com)

## Javelot Turbo

**OLIGHT** NEW Javelot Turbo  
**EXTEND THE POSSIBILITIES**  
ULTRA-BEAM DISTANCE FLASHLIGHT

**1,300 LUMENS** | **1,300 METERS**

LIMITED  
DESERT TAN | BLACK

MAX OUTPUT	MAX RUNTIME	MAX THROW	BATTERY	DROP TEST	WATERPROOF
<b>1,300 LUMENS</b>	<b>318 HOURS</b>	<b>1,300 METERS</b>	<b>10000mAh 3.6V BATTERY PACK (INCLUDED)</b>	<b>1 METER</b>	<b>IPX8</b>

**1,300 LUMENS** | **1,300 METERS**

**LONGEST BEAM DISTANCE IN ITS CLASS**

A high-performance LED offers an excellent beam distance of 1,300 meters (4,265ft), making it the new king of throw flashlights species.



**COMPACT SIZE WITH SUPERSIZED BATTERY**

10000mAh large-capacity battery pack guarantees 318 hours of runtime and can quickly be replaced. Always ready to get back in the action.



# Olight

[www.olightworld.com](http://www.olightworld.com)

## M2R PRO

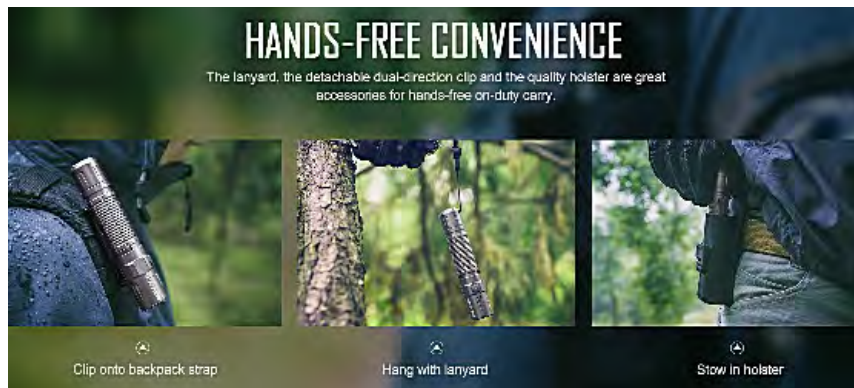

 MAX OUTPUT <b>1,800 LUMENS</b>	 MAX RUNTIME <b>50 DAYS</b>	 MAX THROW <b>300 METERS</b>
 BATTERY CUSTOMIZED 5000mAh 21700 RECHARGEABLE LITHIUM BATTERY (INCLUDED)	 DROP TEST <b>1.5 METERS</b>	 WATERPROOF <b>IPX8</b>

# Olight

[www.olightworld.com](http://www.olightworld.com)

## Baton 3 Premium

**NEW Baton 3** Black | Red

### DESIGNED TO STAND OUT

UPGRADE YOUR POCKET FLASHLIGHT EXPERIENCE

**1,200 LUMENS**

CHARGE 3.7 TIMES

Standard Edition Premium Edition

<b>MAX OUTPUT</b>	<b>MAX THROW</b>	<b>STANDARD</b>	<b>PREMIUM</b>	<b>DROP TEST</b>	<b>BATTERY</b>	<b>WATERPROOF</b>
1,200 LUMENS	166 METERS	20 DAYS	94 DAYS	1.5 METERS	CUSTOMIZED BATTERY	IPX8

**NEW TEXTURE, BETTER GRIP**

The same tiny 2.48-inch-long body comes with a finely-milled new texture.

Still utterly portable, but looks more exquisite with enhanced grip.

**IMPROVED EFFICIENCY AND RUNTIME**

The Baton 3 boasts a max runtime of 20 days and 3.7 times more with the Premium Edition.

Baton II	8 Days
Baton 3	20 Days
Premium Edition	94 Days

**A CUSTOMIZED POWER BANK FOR BATON 3**

Tailor-made for the Baton 3. It takes in power via the popular Type-C port and pumps out power via a magnetic port, making charging a breeze.

**HANDS-FREE CONVENIENCE**

Clip it onto a cap brim or backpack strap in either direction, or attach its magnetic tail onto any iron surface. Rugged enough to survive occasional water immersion and falls.

**TAKE YOUR POCKET LIGHT UP A NOTCH**

**1,200 Lumens** | **166 Meters**

A meaningful upgrade from the S1R Baton II, our currently most popular pocket light.



# Olight

[www.olightworld.com](http://www.olightworld.com)

## OPEN 2



### FINELY DETAILED BOLT ACTION MECHANISM

One push of the small bolt to access or retract the pen tip. Smooth bolt action for fast and precise writing.



### SEPARABLE AND DEPENDABLE

Ideal for nighttime writing and reading.



### ADDED SECURITY AND CONFIDENCE

Rechargeable LED light, only 55 minutes to be fully charged. Up to 10 hours of runtime.



### ONLY 1.34oz/38g WITH SECURE POCKET CLIP

Lightweight EDC light with a durable pocket clip for secure grip on shirt pockets, bags, and more. Perfect for outdoor use.



MAX THROW  
16 meters

### AN EXCELLENT GIFT

Especially for ones who need to jot down notes in low light conditions. The added refill gives you extra assurance.



Rechargeable LED Light

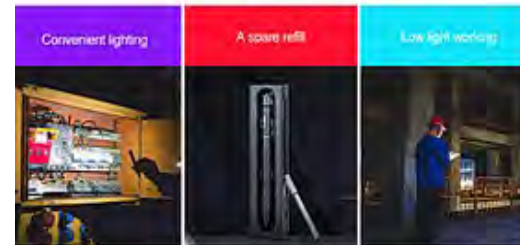

Convenient lighting

A spare refill

Low light working

MAX OUTPUT  
120 LUMENS

MAX RUNTIME  
10 HOURS

BATTERY  
3.7V 110mAh/407mWh  
RECHARGEABLE LITHIUM  
POLYMER BATTERY  
(DUK1-00)

PRODUCT WEIGHT  
1.34oz/38g  
(INCLUDING BATTERY AND REFILL)

# Olight

[www.olightworld.com](http://www.olightworld.com)

## Obulb

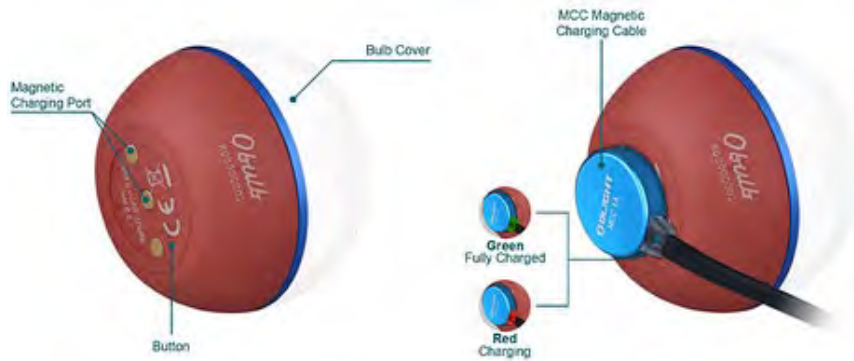



# Olight

## Olantern

[www.olightworld.com](http://www.olightworld.com)

**GESTALTEN SIE IHRE GLÜCKLICHEN MOMENTE**  
 ein warmes Abendessen, ein romantisches Date,  
 ein leckeres Barbecue, eine fröhliche Hausparty ...

mit dem austauschbaren LED-Modul "flackernde Kerze"



**JUST PLAY HAVE FUN**

- 1 Cover to detach
- 2 LED modules: white light & flaming
- 3 Brightness levels: 30-120-360 lumens



MAX BRIGHTNESS	MAX RUNTIME	PROP. TEST	BATTERY	WATERPROOF	WEIGHT
360 LUMENS	80 HOUR	✓	1800mAh (3000mAh)	IPX4	0.24kg/5.3lb

Leichtes Wackeln an der Laterne in der Nacht, lässt die LED am Einschaltknopf leuchten. So lässt sich der Schalter auch bei völliger Dunkelheit finden.



**ERHELLEN SIE IHREN CAMPINGPLATZ**  
 Holen Sie sich das richtige Licht gehen Sie nach draußen, um ein Abenteuer zu erleben  
 Park, Garten, Wohnmobil-Camping...  
 Machen Sie Ihre Reise hell!

mit dem austauschbaren LED-Modul "High-Performance 360° LED"



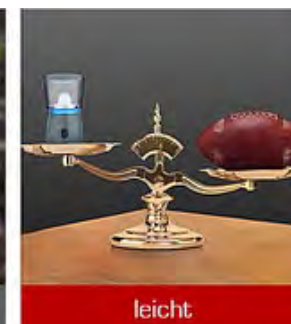

# Olight

[www.olightworld.com](http://www.olightworld.com)

## i5UV

**NEW i5UV EOS**  
**MONO-OUTPUT**  
**EDC ULTRAVIOLET**  
**LIGHT**

WAVELENGTH	OPTICAL POWER	MAX. BATTERY	WEIGHT	BATTERY	DROP TEST	WATERPROOF
365 nm	1,500 mW	45 MINUTES	2.22oz / 63g	1.5V AA ALKALINE BATTERY (INCLUDED)	1.5 METERS	IPX8

**ONE AND ONLY**  
 Custom laser etching with specialized magnetic film. Each flashlight is unique.

**STRONGER FLUORESCENCE**  
 365nm LED emits a dull, bluish-white light. NO interruption. Stronger visibility. Get a better look at what you could not see before!

**MAKING THE INVISIBLE VISIBLE**  
 Reveal hidden stains and pet accidents on the carpet. Keep the house clean!

Detect House Stains

Check Counterfeit Currency

IPX8 Waterproof

Double Hex Knurling  
 Patented Reflector  
 High Efficiency UV LED  
 Anti-slip Tail Switch  
 Three-way Pivot Cap



### LIGHT SOURCE

High Efficiency 365nm UV LED

### DIMENSIONS

Length: 3.74in/95mm  
 Head Diameter: 0.70in/17.8mm  
 Body Diameter: 0.70in/17.8mm

### WEIGHT

2.22oz/63g (including Battery)

### BODY MATERIAL

Aluminum Alloy

### POWERED BY

AA Alkaline Battery (Included)

### WARRANTY

Olight's 5-Year Warranty  
 Visit: <https://olightworld.com/olight-warranty>

### IN THE BOX

Flashlight i5UV EOS (Battery Included) x 1  
 User Manual x 1

<p>WATERPROOF IPX8</p>	<p>DROP TEST 1.5m</p>	<p>COMPLIANCE CE RoHS</p>
----------------------------	---------------------------	-----------------------------------



# Olight

www.olightworld.com

## X9R MARAUDER

**OLIGHT™**  
**MASTERPIECE**  
 THE ULTIMATE TORCH **X9R MARAUDER**

**25,000**  
**LUMENS**

**SHOULDER STRAP FOR HANDS FREE CARRY**

**IPX7 WATERPROOF RATING**

**EFFECTIVE VENTILATION FOR POWERFUL HEAT CONTROL**

The X9R includes a custom heat dissipation system featuring a fanless heat sink and design and optimized fan-based producing increased airflow and a highly reflective surface area. The heat sink is made of aluminum and is safe to hold for long periods of time.

**8-LEVEL OUTPUT & POWER DISPLAY**

**OUTPUT SELECTION:** Light and beam color change

**POWER INDICATION:** Always remaining battery level

**FAST CHARGING**

Included DC adapter that fully charges the X9R in 4 hours.

**ERGONOMIC PADDED FINGER GROOVES**

When pushing an extremely comfortable grip, the X9R's finger grooves also help you locate the push button easily in the dark.



**X9R MARAUDER INTRODUCTION**

With an incredible 25,000 lumens output, the X9R is the most powerful Olight ever produced. This beam is equipped with the Cree XP672 LEDs and is powered by a removable battery pack that contains 5 high-capacity 18650s that are easily recharged simply by plugging it in. The X9R features a tactile side switch surrounded by 8 blue LEDs on each side displaying output level, remaining power level, or charging status. It also comes in a hard case including charging cable and a shoulder strap for convenient carry. The X9R Marauder is the best option for intense output, long runtimes, and maximum use for work to life.

**HEAVY DUTY CASE**

Waterproof, dustproof, and shock proof carrying case. Perfect for outdoor and commercial carry.

<p><b>MAX</b></p> <p><b>25,000</b> lumens</p>	<p><b>TOTAL</b></p> <p><b>27</b> hours</p>	<p><b>THROW</b></p> <p><b>630</b> meters</p>	<p><b>CANDELA</b></p> <p><b>99,200</b> cd</p>	<p><b>WATERPROOF</b></p> <p><b>IPX7</b></p>
---	--	--	---	---

# Olight

www.olightworld.com

## I1R EOS

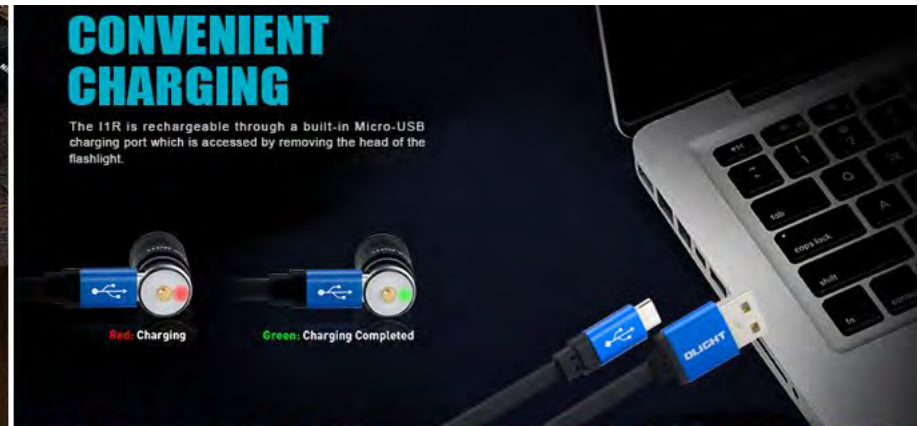

	MODE 1	MODE 2
<b>OUTPUT</b>	130 lumens	5 lumens
<b>RUNTIME</b>	20 minutes	7 hours
<b>THROW</b>	54 meters	13 meters
<b>BEAM INTENSITY</b>	730 cd	40 cd
<b>LIGHT SOURCE</b>	Philips LUXEON TX LED	
<b>MATERIAL</b>	Aluminum Alloy	
<b>WEIGHT</b>	0.42 oz/12g	
<b>DIMENSION</b>	(L)1.61 in/41mm x (HD)0.55 in/14mm x (BD)0.55 in/14mm	
<b>CGT</b>	6500K	

# PowerTac

## FLASHLIGHTS

www.powertac.com

### Some Clients for your reference:

- US Law Enforcement: FBI, CIA, Secret Service that protect President, State Police, Sheriff.
- IACP (International Association Chief of Police) Members
- Israel Police & Military.
- Forensic Flashlights Clients from Canada, Australia, UK.

- We offer Life-time Warranty for all of our Flashlights.
- PowerTac flashlights has been qualified by military, law enforcement and outdoor customers in the US.
- **Approved and purchased in large quantity by Israel military in 2018.**
- More dealers/customers in other European countries are in progress.
- R&D and designed in the USA, making sure the product concepts are coming from end customers.
- Manufactured in China, to guarantee more competitive prices.



### E20 EVERY DAY CARRY FLASHLIGHT

**1800 MAX LUMENS**

**NEW PRODUCT 2018**

Reverse On/Off Reversible Clip, Striking Bezel, Magnetic Torpedo, On/Off / Mode Change Button, MACHINED ALUMINUM with anti-slip knurling, Anti-Fog, Waterproof sealed Glass.

LED Type: Cree XM-L2 U3 White LED  
Battery: (2) CR123A or (1) 18650 Rechargeable Li-Ion

Size: Length: 115 mm, Rear Diameter: 25.4mm, Body Diameter: 23.8mm  
Weight: 64g (without battery)

ILLUMINATION FUNCTIONS	Flash	Low	Medium	High	Turbo	Strobe
(2000 mA) Max Output:	81 lm	50 lm	200 lm	400 lm	1180 lm	1180 lm
Battery:	20 Days	20 hrs	10.5 hrs	5.3 hrs	2.8 hrs	3 hrs
2 x CR123A Max Output:	1.8 m	40 lm	180 lm			
(20) Runtime:	35 Days	40 hrs	10.5 hrs			

Max 1180 Lumens, Max 25 Days, Max 130 Meters, Impact Resistant, Waterproof and Submersible IPX3

### E5 TACTICAL FLASHLIGHT

**1800 MAX LUMENS**

**NEW PRODUCT 2018**

Striking Bezel, Secondary Mode Change Button, Heavy Duty Reversible Clip, MACHINED ALUMINUM with anti-slip knurling, Anti-Fog, Waterproof sealed Glass.

LED Type: Cree XM-L2 U2 White LED  
Battery: (2) CR123A or (1) 18650 Rechargeable Li-Ion. NOT compatible with RCR123A / 16340

Size: Length: 128.5mm, Bezel Diameter: 25.4mm, Body Diameter: 22mm  
Weight: 69g (without battery)

ILLUMINATION:	2 Lumens	82 Lumens	416 Lumens	500 Lumens	600 Lumens	600 Lumens (Strobe)
Runtime:	706 hrs	16 hrs	3 hrs	1.5 hrs	3 hrs	3 hrs

Max 910 Lumens, Max 706 Hours, Max 240 Meters, Impact Resistant, Waterproof and Submersible IPX3

### E9R USB RECHARGEABLE TACTICAL FLASHLIGHT

**1000 MAX LUMENS**

**NEW PRODUCT 2018**

Micro On/Off Reversible Clip, Direct to Stroke / Secondary Mode Change Button, Striking Bezel, Pressure Sensitive Rear On/Off Button, MACHINED ALUMINUM with anti-slip knurling, Anti-Fog, Waterproof sealed Glass.

LED Type: Cree XM-L2 U3 White LED  
Battery: (1) 18650 Rechargeable Li-Ion. NOT COMPATIBLE WITH RCR123A / 16340

Size: Length: 140mm, Bezel Diameter: 25.4 mm, Body Diameter: 23 mm, Weight: 82.7g (without battery)

ILLUMINATION:	1 Lumens	150 Lumens	415 Lumens	1020 Lumens	1020 Lumens (Strobe)
Runtime:	305 hrs	5.3 hrs	5.3 hrs	2.4 hrs	5 hrs

Max 1020 Lumens, Max 305 Hours, Max 226 Meters, Impact Resistant, Waterproof and Submersible IPX3

### M5 USB / MAGNETIC RECHARGEABLE FLASHLIGHT

**900 LUMENS**

**NEW PRODUCT 2018**

Micro On/Off Reversible Clip, Heavy Duty Reversible Clip, MACHINED ALUMINUM with anti-slip knurling, Pressure Sensitive Rear On/Off Button, LOW VOLTAGE HOLDUP MOTOR CHARGING SYSTEM, BATTERY OVERHEAT PROTECT.

LED Type: Cree XM-L2 U3 White LED  
Battery: (1) 18650 Rechargeable Li-Ion, NOT COMPATIBLE WITH RCR123A / 16340

Size: Length: 135 mm, Rear Diameter: 25.4mm, Body Diameter: 23mm  
Weight: 64g (without battery)

ILLUMINATION FUNCTIONS	Low	Medium	High	Turbo	Strobe
(2000 mA) Max Output:	30 lm	100 lm	400 lm	1000 lm	1000 lm
Battery:	30 Days	30 hrs	15 hrs	8 hrs	3 hrs
2 x CR123A Max Output:	20 lm	60 lm	200 lm	400 lm	400 lm
(20) Runtime:	30 Days	30 hrs	15 hrs	8 hrs	3 hrs

Max 900 Lumens, Max 706 Hours, Max 240 Meters, Impact Resistant, Waterproof and Submersible IPX3

### SCHOLAR TACTICAL FLASHLIGHT PEN

**1800 MAX LUMENS**

**NEW PRODUCT 2018**

Striking Bezel, Stainless Steel Clip, On / Off Button, Fine Gel Tip Pen.

LED Type: Cree XP-C2  
Battery: 1 AAA - Alkaline, NiMH (Batteries NOT included)

Size: Length: 150 mm, Body Diameter: 14.5 mm  
Weight: 35g (without battery)

ILLUMINATION: 1xAAA 3 Lumens, 140 Lumens, 140 Lumens (Strobe), 1.2 hrs, 1.2 hrs

### THE PATHFINDER RECHARGEABLE MULTI COLOR FLOOD LIGHT

**6,000 MAX LUMENS**

**NEW PRODUCT 2018**

MACHINED ALUMINUM with anti-slip knurling, Heavy Duty Reversible Clip, On / Off Button, Mode Change Button, RECHARGEABLE CHARGE PORT, BATTERY INDICATOR, USB Output Port, 12V Input Port, Battery Level Indicator Light.

LED Type: Cree XP-C2 (White), Cree XP-C2 (Red), Cree XP-C2 (Blue), Cree XP-C2 (Green)

Battery: Custom 4 Cell 18650 (2400mAh)

Size: Length: 160 mm, Rear Diameter: 88 mm, Body Diameter: 80 mm, Weight: 770g (with battery)

ILLUMINATION:	Low	Med/Low	High	Strobe	S.O.S
White Output / White Runtime:	400 Lumens / 3.5 hrs	800 Lumens / 1.5 hrs	1000 Lumens / 1.1 hrs	1000 Lumens / 2.3 hrs	1000 Lumens / 2.3 hrs
Red Output / Red Runtime:	-	-	100 Lumens / 18 hrs	100 Lumens / 20 hrs	-
Green Output / Green Runtime:	-	-	100 Lumens / 18 hrs	100 Lumens / 20 hrs	-
Blue Output / Blue Runtime:	-	-	100 Lumens / 18 hrs	100 Lumens / 20 hrs	-

Max 11,000 Lumens, Max 0.55 Hours, Max 468 Meters, Impact Resistant, Waterproof IPX3

### X10000 RECHARGEABLE FLOOD LIGHT

**10,000 MAX LUMENS**

**NEW PRODUCT 2018**

MACHINED ALUMINUM with anti-slip knurling, Mode Dial, Heavy Duty Reversible Clip, On / Off Button, Heat Sink & Ball in Waterproof Cooling Fan, USB Output Port, 12V Input Port, Charge Port, SNAK Indicator, Battery Level Indicator Light.

LED Type: (1) X10-010, (8) X10-012  
Battery: Custom 4 Cell 18650 (2400mAh)

Size: Length: 300 mm, Rear Diameter: 90 mm, Body Diameter: 60 mm, Tripod Diameter: 10 mm

ILLUMINATION: Max 15 Hours, Max 675 Meters, Impact Resistant

\* Actual test is done with one 18650 mAh 3.6V battery in PowerTac Kit.

# PowerTAC

[www.powertac.com](http://www.powertac.com)

## M5 & E9R-G4

### POWERTAC M5

#### EXTREMELY PORTABLE

#### 1300 LUMENS · 220 METERS

DUAL SWITCH

HIGH OUTPUT

COMPACT SIZE

MAGNETIC CHARGING

**NEW 100% T3 LED**  
Lifetime: 50,000hrs

**NEW 100% T3 LED**  
Excellent Light Transmission & Scratch-resistant

**EASY USER INTERFACE**  
KEEP 8 SWITCHES (5/6/7/8/9) FOR TACTICAL OPERATION  
LONG PRESS SYSTEM  
ONE CLICK TO ACCESS EACH MODE

**INTELLIGENT SAFETY SYSTEM**

- Over Charging Protection
- Over Discharging Protection
- Reverse Polarity Protection

**SMART SIZE FOR EASY CARRY**  
Most Compact in the Class yet 1300  
With 100% Output, Best Performance & Longevity

**MAGNETIC CHARGING**  
M5: 100% T3 LED & 50,000hrs Charging System  
M5: 100% T3 LED & 50,000hrs Charging System  
M5: 100% T3 LED & 50,000hrs Charging System

Red Charging    Blue Charging

**IPX8 WATER PROOF**

### E9R-G4

#### EXTREMELY POWERFUL/TACTICAL

DUAL CHARGING SYSTEM (MAGNETIC + Micro USB)

HIGH OUTPUT, DUAL SWITCH SYSTEM

## 2550 LUMENS

NO HASSLE LIFETIME WARRANTY

NEW

**LOW PROFILE OUTLINE DESIGN EASY TO OPERATE**

- Low Battery/Charging Indicator
- Pocket Clip
- Head
- Micro USB Charge Port
- Magnetic Charge Port
- Side Switch
- Back Switch: Main on/Off

**AMAZING LONG RUNTIME**  
FIREFLY MODE: 0.6-4LM/50 DAYS

1\*18650 ≈ 1 MONTH

**UNIQUE DIGITAL CIRCUIT TECHNOLOGY**

- Upgrade LED Circuit System
- Intelligent High Output Technology
- Unique Thermal Protection System
- Unique Quick Charging System (Magnetic + Micro USB)
- Over Current Protection
- Over Charging Protection
- Over Discharging Protection
- Reverse Polarity Protection

**EXTREMELY HIGH OUTPUT: 2550LM**  
**LONG DISTANCE: 97M**

**CREE XHP50 LED**  
LIFETIME: ≥ 50000HRS

**DUAL CHARGING SYSTEM (MAGNETIC + Micro USB)**  
EASY TO USE, CONVENIENT

RED: MICRO USB CHARGE PORT  
BLUE: MAGNETIC CHARGE PORT

**DUAL CHARGING SYSTEM (MAGNETIC + Micro USB)**  
EASY TO USE, CONVENIENT

RED: MICRO USB CHARGE PORT  
BLUE: MAGNETIC CHARGE PORT

# PowerTAC

[www.powertac.com](http://www.powertac.com)

## WATCHDOG

**WATCHDOG OD-XLT**  
**SEARCH & RESCUE LONG THROW LIGHT**  
**CAN ALSO WORK AS BATON ("2 In 1")**

DUAL SWITCH SYSTEM   
 MAGNETIC CHARGING SYSTEM   
 DUAL LIGHT SOURCES SYSTEM (FOCUSED/DIFFUSED LIGHT)  
 MULTI-COLOR OUTPUT 



**1050M**  
**2300LM**

NO HASSLE LIFETIME WARRANTY  **NEW** 

**LOW PROFILE OUTLINE DESIGN**  
**EASY TO OPERATE**



Magnetic Charging Port  
 Tail Cap  
 Battery Tube  
 Power Switch/Low Battery Indicator  
 Mode Change  
 Head

**EXTREMELY HIGH OUTPUT: 2300LM**  
**LONG DISTANCE: 1050M**

**AMAZING LONG RUNTIME**  
**LOW MODE: 10 LM/14 DAYS**



**LIFETIME: ≥ 50000HRS**

(1) White Focused Light:  
 Cree XHP35 HI White LED

(2) Color Diffused Light:  
 White: Cree XQE-R3  
 RED: Cree XQE-RED  
 Green: Cree XQE-Green  
 Blue: Cree XQE-Blue

White Focused Light							
ANSI/NEMA FL1	FL 1 STANDARD 1000 LUMENS	FL 1 STANDARD 00h	FL 1 STANDARD 0000cd	FL 1 STANDARD 100m	FL 1 STANDARD 0m	FL 1 STANDARD 00m	
Mode	Max Output	Run Time 32650-6500mAh(3.6V)*2 Built-in Li-ion Battery Pack		Beam Intensity	Beam Distance	Impact Resistant	Water Resistant
High	2300LM	2.96HRS		275625CD	1050M	2 M	IPX8
Medium	760LM	5.32HRS					
Low	160LM	28.4HRS					
Firefly	10 LM	14 DAYS					
Strobe	2300LM	6HRS					
SOS	2300LM	6HRS					
Color Diffused Light							
	White	Red	Green	Blue			
	180 LM/12 HRS	50 LM/630nm/14 HRS	140 LM/530nm/12 HRS	30 LM/460nm/12 HRS			

**UNIQUE DIGITAL CIRCUIT TECHNOLOGY**  
 Unique LED Driving System:  
 Intelligent High Output Technology  
 Unique Thermal Protection System  
 Dual Switch System  
 Over Current Protection  
 Over Charging Protection  
 Over Discharging Protection  
 Reverse Polarity Protection

**MAGNETIC CHARGING SYSTEM**  
**EASY TO USE, CONVENIENT**



RED: BATTERY CHARGING  
 BLUE: BATTERY CHARGING

**Perfect Size: Can work as Baton**

**Size:**  
 Head Diameter: 80mm  
 Body Diameter: 37.4mm  
 Length: 287.3mm  
 Weight: 880g (Battery Included)



**IPX8** Waterproof  
 (2m submersible)

T1



**SPERAS**

**T1 1300 METERS**

**1300M 1200LM**

OSRAM LED  
+  
Unique Drive Circuit & High Efficiency Optical System  
▼  
Break the Darkness, Extend the limits

**T1**

## Super Beam Distance Beyond Your Limits

SPERAS T1 has a super beam distance of 1300m and a high performance of 1200lm, a customized OSRAM LED, a synchronous step-down circuit with high efficiency up to 92% and a special optical system. It is an excellent long-rang flashlight. The tail button has mode memory function and can switch between ON, momentarily-ON and quick strobe functions. LED breathing function with 7 changing colors gives you a different experience. T1 is suitable for the police and military, law enforcement, search and rescue, hunting and other outdoor activities.



**SPERAS**

**T1 1300 METERS**

**Over-Discharge Protection Function**

Automatically downshift when the battery is low, preventing battery over discharge.



**SPERAS**

**T1 1300 METERS**

**Standard Waterproof IPX8**

\*Applicable for severe environment

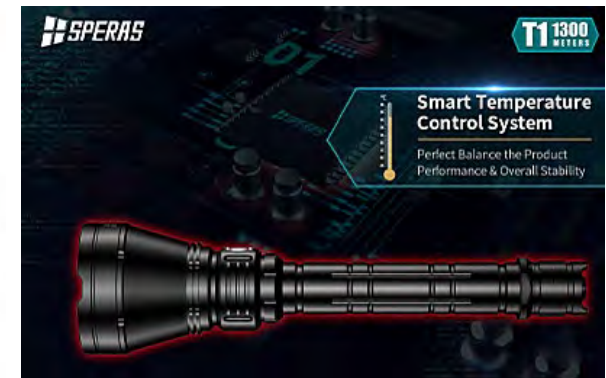

**SPERAS**

**T1 1300 METERS**

**Smart Temperature Control System**

Perfect Balance the Product Performance & Overall Stability



SMART HOME / SECURITY

## Smart Heating Management

- Comfort control
- Controlled by Smartphone
- Easy installation

**eco ENERGY SAVING**

**bimar** SINCE 1974  
LIVE + SMART

Customise the desired temperature in each room via App.

19.0°C LIVING ROOM

20.5°C BATHROOM

18.0°C BEDROOM

amazon alexa ENABLED

works with the Google Assistant

**Bimar Live Smart**

Remotely controlled through the Bimar Live Smart App. Set the desired temperature (5-30)°C in each room for you well-being, where, how and when you want: Bedroom at 18°C, Living room at 19°C and bathroom at 20.5°C.

Powered by **tuya** Intelligence Inside



### Wifi + Zigbee Thermostatic Radiators Valve

- Easy to install and control remotely via the Bimar Live Smart App.
- Battery-operated (2x1,5V type AA). Included in the box.
- Set of adaptors, compatible with most radiators, included in the box (Caleffi, Giacomini, M28x1,5), RAVL, RA, RAV).
- App compatible with iOS and Android, Wifi 2,4GHz+ Zigbee.
- Many preset programs (Eco, Comfort, Holiday, etc).
- With APP the thermostatic valve can be automated, programmed daily and weekly.
- Voice control compatible with Amazon Alexa and Google Assistant.
- Additional function: in combination with the door/window sensor automatically interrupts heating by interacting with the Gateway.
- Set the customised temperature (5-30)°C in each room for your comfort, where, how and when you want. Example: bedroom at 18°C, living room at 19°C and bathroom at 20.5 °C.
- Energy saving e comfort control.
- Functions: "Child Lock" and "Defrost".



**COMFORT ROOM FOR ROOM**

**OPEN WINDOW DETECTION**

**CONTROLLED BY SMARTPHONE**

**EASY INSTALLATION**

### Gateway Zigbee Wireless

- Network device connecting thermostatic valve and door and window sensor to the Wi-Fi (2.4)GHz home router.
- Zigbee 3.0 is a wireless technology for connecting smart devices.
- Connects up to 60 devices at once.
- App Bimar Live Smart compatible with iOS and Android for the control.
- USB cable included.
- Easy to install.



# Canyon

[digital.canyon.eu](http://digital.canyon.eu)

## Smart Band for Seniors



### KEY FEATURES

- Location tracking with GPS / LBS / WI-FI
- SOS button (telephone connection)
- Two-way telephone communication
- Voice chat
- IP67 waterproof
- Voice assistant
- Handsfree function
- Heart rate monitor (with data transfer)
- Pedometer
- Economical energy consumption
- Compatible with Android 4.4+ and IOS 8.5+
- Hypoallergenic strap



# Dreiklang

## Bluetooth Tracker

Nichts mehr verlieren Dreiklang – be smart® Bluetooth Tracker Tag mit Anhänger

Wiederfinden leicht gemacht



App für iOS und Android



außer Reichweite Alarm



Laut: 90 db, wasserabweisend



CR 2032 Batterie: ca. 1 Jahr



Ausstattung: Band + Ersatzbatterie

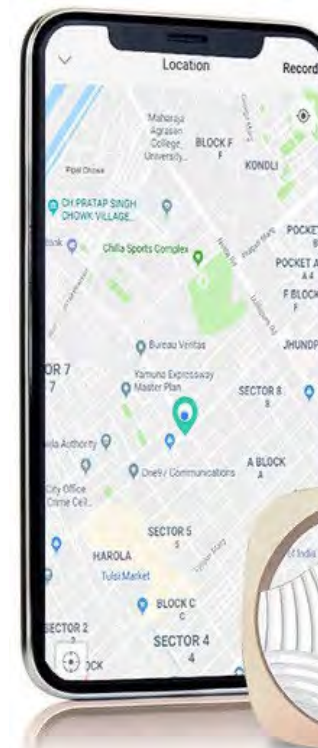
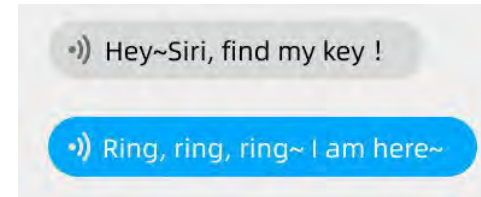

# Fixed

## Smart Tag

- Unique Bluetooth tracker
- Monitors movement, temperature and humidity and also controls smart home!

### MODERN TECHNOLOGY, COMPACT DESIGN

FIXED Sense packs in the latest technology including motion, temperature and humidity sensor, location recording and connectivity with smart devices from a variety of manufacturers.

- ✔ **Minimalist**  
4 cm in diameter
- ✔ **Smart buttons**  
Customizable functions, up to 8 combinations
- ✔ **Bluetooth 5.0**  
Low Energy profile with a range of up to 60m
- ✔ **Multipoint**  
Sharing one Sense to multiple users
- ✔ **Replaceable battery**  
CR2032 with 1 year battery life
- ✔ **OTA updates**  
Continuous software upgrade
- ✔ **Polyphonic ringtone**  
10 different melodies
- ✔ **LED diod**  
for discrete search
- ✔ **Universal compatibility**  
Android 5.0+ and iOS 12.0+



### LOOKS AFTER, PROTECTS, ANALYZES, CONTROLS.

FIXED Sense is a revolutionary smart pendant that looks after your personal belongings, protects them from theft, detects ambient temperature and humidity and controls your smart home.

**Looks after your belongings**  
thanks to Bluetooth connection with your phone or tablet

**Finds lost item**  
with radar, beeping, flashing or marking its location on a map

**Motion sensor**  
when activated, it alerts you whenever Sense moves

**Family sharing**  
allows one Sense to connect to multiple devices simultaneously



**Temperature and humidity sensors**  
monitor and record readings in the SMART app

**Controls a smart home**  
e.g. Phillips Hue lighting

**Smart buttons**  
for customizing Sense features

**FIXED Smart**  
an app developed in the Czech Republic for Sense control

# Fixed

[www.fixed.zone/](http://www.fixed.zone/)

## Smile Pro BT-Locator

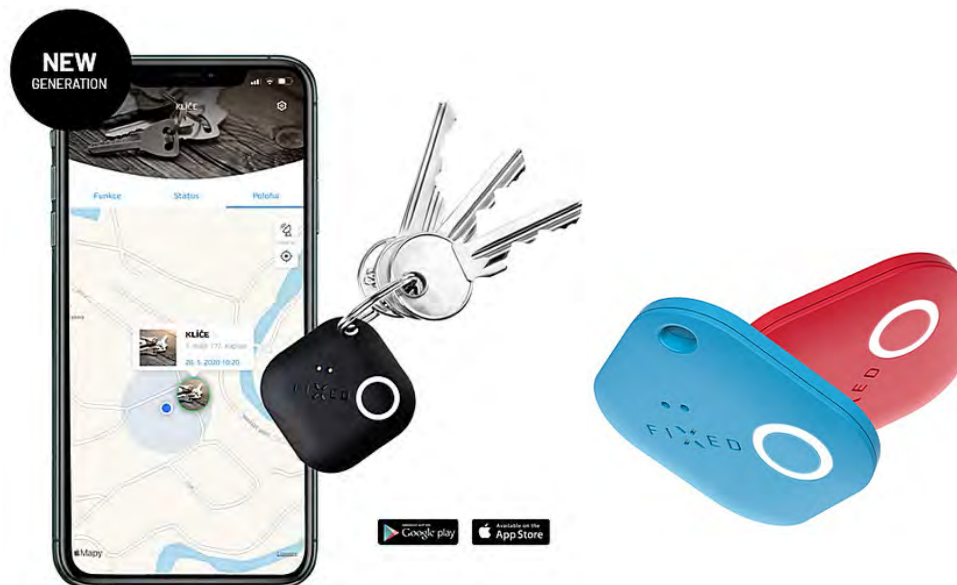

### Tracking

Simply attach FIXED Smile PRO to the item you want to keep an eye on. Pair it with your phone via Bluetooth and with the help of the app, you have immediately everything under control.



### Motion sensor

Smile PRO has an integrated motion sensor that, when activated, alerts you to unintended or unwanted movement. You will be immediately notified via the app and the tracker will set off a loud alarm.



### Family sharing

Are you afraid that your child will stray on his/her way to school? If your children have shared Smile PRO attached to their phones, you can check that they are where they are supposed to be in a second.

#### MULTICONNECTION

The possibility to connect to multiple devices at the same time.

### Last tracked position

The paired tracker works via Bluetooth. If it is disconnected, it will record the location where it happened. You can then see the exact position, where Smile PRO has disconnected, on the map.



# Fixed

## Smile Pro BT-Locator Wallets

Unlike a classic wallet, the FIXED Smile Pro Bluetooth locator is hidden inside the FIXED smart wallet to keep it safe.

Just pair it with your mobile phone and you'll always have a clear view of your wallet's whereabouts at the click of a button



Leather hand-sewn wallet with smart locator



### WALLET

A modern minimalist wallet made of genuine leather that you won't even feel in your pocket.

The Smile Wallet holds the essentials - your credit card, documents and a few banknotes.



### WALLET XL

A luxurious hand-sewn genuine leather wallet that easily fits all your essentials for everyday life.

Inside you will find two pockets for larger documents, smaller compartments for credit cards and ID cards, and two pockets for small coins.



### CLASSIC WALLET

A luxurious genuine leather wallet that fits everything important for holidays and business trips.

Inside you will find 4 credit card pockets, a large bill pocket, a zippered coin pocket, an inside hidden pocket and a small pocket.



### TINY WALLET

A modern minimalist wallet made of genuine leather that you won't even feel in your pocket.

Tiny Wallet can hold a credit card, documents and a few banknotes.



# Fixed

## Apple AirTag Wallets & Keychains





# Lamax

[www.lamax-electronics.com](http://www.lamax-electronics.com)

## DashCam S9

### Die (fast) unsichtbare Dashcam

AUTO BILD hat die Lamax S9 getestet. Sie ist Dashcam, Rückfahrkamera und smarterer Rückspiegel in einem. Im Test kann sie voll und ganz überzeugen. Vor allem die Sprachsteuerung fällt positiv auf.



# Nedis

[www.nedis.com](http://www.nedis.com)

## SmartLife



Cameras • Video Doorbells • Plugs • Wall Switches • Lighting • Detectors, Sensors & Remote • Cooling • Heaters • Flora & Fauna • Personal Care • Cleaning • Zigbee



### Wall Switch

- Connects directly to your router via Wi-Fi - no separate hub required
- Replace your wall switch to control your existing traditional lighting?
- Use voice control (in combination with Amazon Alexa or Google Home)
- Combine with other Nedis SmartLife products or set a schedule



## Smart Radiator Control

- SmartLife Radiator Control | Zigbee 3.0 | Battery operated | LCD | Android™ / IOS



## Zigbee Gateway WIFIZB10WT

Wi-Fi / Zigbee 3.0 | 40 Geräte | Stromversorgung über USB | Android™ / IOS | Weiss

## Smart Klimasensor

Zigbee 3.0 | Batteriebetrieben | Android™ / IOS | Weiss



# PE-SOS

## EMERGENCY SMART FINDER

**Alleine unterwegs - trotzdem sicher!**

Falls doch mal was passiert -

**Knopfdruck genügt, um Hilfe zu holen.**

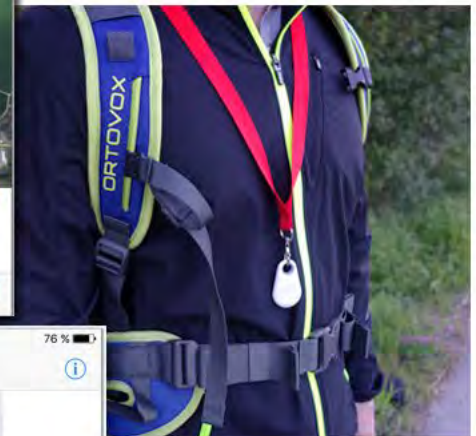

**Wenn telefonieren  
nicht mehr  
möglich ist**

**Notfallknopf  
für  
Smartphones**

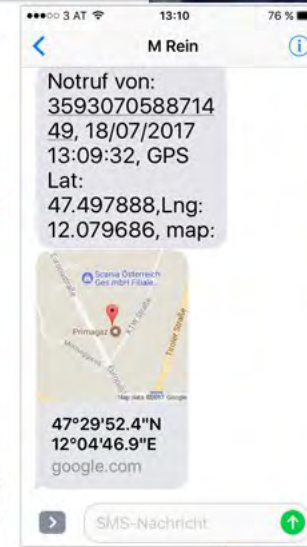

Mi 10.08.2016 08:31  
admin@transport-inside.com  
ALERT Device 160198237645108  
An admin@transport-inside.com  
Cc r.mairhofer@transport-inside.com  
  
SOS call from Device  
Betr./Ref. Alert Object: Test Julia iPhone,  
Gerät: 160198237645108  
  
Status: 3  
Uhrzeit: 10.8.16 06:30 UTC  
A service of ticom internetservices Kufstein/Austria  
  
[View on Google Maps](#)



# Plegium

[www.plegium.com](http://www.plegium.com)

## COMBO PEPPER SPRAY

**It screams** with 130dB volume

**It flashes** like a bright stroboscope

**Its spits** 10 foot pepper spray

**AND ALL AT THE SAME TIME!**



**PRESS THE TRIGGER  
TO SIMULTANEOUSLY ACTIVATE THREE FUNCTIONS**

### Pepper Spray

Maximum strength pepper spray,  
with up to 10 bursts and 3 meter range

### Personal Alarm

Ear-piercing 130 dB personal alarm signals for help -  
stronger than many standalone personal alarms

### Strobe LEDs

Triple strobe LEDs illuminates the scene which helps you aim,  
and their 19 times-per-second blinking disorients the attacker



## COMBO Pepper Spray



SAFETY LID  
AND TRIGGER

STROBE LEDs



ALARM  
SPEAKER



### SABRE Red Pepper Spray

**4-Year No-Charging Battery Life**

(Batteries included and built-in)



# Qnect

## Smart WiFi plugs



Smart WiFi plug | 16A | EU type  
QN-WP01 | QN-WP01 DUO

- Connects directly to your home Wi-Fi network
- 16A - 3600W
- Schuko Type EU
- With ON/OFF button
- Set timers and schedules
- Create actions and automations
- Control by voice
- ø 60 x 65 mm



Smart WiFi outdoor plug | 16A IP44 | type F and E  
QN-WP06

- Connects directly to your home Wi-Fi network
- 16A - 3680W
- With ON/OFF button
- IP44 waterproof
- Set timers and schedules
- Create actions and automations
- Control by voice
- 60 x 95 x 75 mm



Switch - Timer - Schedule



Energy monitor



Smart WiFi plug | 16A | Energy monitor | EU type  
QN-WP01E

- Connects directly to your home Wi-Fi network
- 16A - 3600W
- Schuko Type EU
- With ON/OFF button
- With energy monitor
- Set timers and schedules
- Create actions and automations
- Control by voice
- ø 60 x 65 mm

# Radarcan

[eu.radarcan.com](http://eu.radarcan.com)

## PROTECTION AGAINST INSECTS AND MORE

### PORTABLE MOSQUITO REPELLER



### FOR CATS AND DOGS



The **DOG BARKING SILENCER PRO** is designed to prevent your dog from barking for no reason when left alone.

This prevents problems with neighbors and helps you train your dog in a harmless way.

### RODENT | COCKROACH REPELLERS



**PORTABLE MOUSE | COCKROACH REPELLER.** Minimalist design. Protects your home by emitting ultrasound waves that are unbearable to mice and cockroaches, driving them away from the area protected by the repeller. Battery operated. Can be taken with you anywhere, even to places where no electrical outlets are available.

**MOUSE | COCKROACH REPELLER HOME.** This is the plug-in version of the previous model, made even smaller to get rid of these little pests.

**RODENT | COCKROACH | BAT REPELLER PRO** is the industrial version. It's more powerful, with double **INSonuerit 3.0** technology to repel rats, mice, cockroaches and bats.

Reaches more corners and covers larger areas than the smaller versions.

### PEST COMPLETE REPELLER HOME



The **PEST COMPLETE REPELLER HOME** is the most complete model we have ever manufactured. It is no longer necessary to have more than one of our products to be free of annoying animals and insects, such as ants, flies, mosquitoes, mice and cockroaches. This model offers all the technologies necessary to fight them all.

#### TECHNICAL SPECIFICATIONS

Reference: R-200  
 Coverage area: 40 m<sup>2</sup> | 430 sq. ft. **INSonuerit 1.0** (Mosquitoes)  
 150 m<sup>2</sup> | 1,615 sq. ft. **INSonuerit 3.0** (Mice and Roaches)  
 250 m<sup>2</sup> | 2,691 sq. ft. **Magneticæ** (Ants)  
 Power source: 240 V AC  
 Energy consumption: 7W  
 Size (mm): 50 x 120 x 50  
 Free of chemicals: No refills

**INSonuerit 1.0 2.0 3.0**



### MOSQUITO REPELLERS



#### MOSQUITO REPELLER HOME TECHNICAL SPECIFICATIONS

Reference: R-102  
 Coverage area: 25 m<sup>2</sup> | 269 sq. ft. (Indoors)  
 Power source: 100 / 240 V AC  
 Energy consumption: 0.35 W  
 Size (mm): 50 x 50 x 28  
 Free of chemicals: No refills



At **RADARCAN**™, we have worked to develop a simple product that is attractive, minimalist and effective. Feel more protected than ever with the new **MOSQUITO REPELLER HOME**.

With the **PORTABLE MOSQUITO REPELLER HOME** you will be able to carry it anywhere without power source, even at camping tents or vehicles.

#### PORTABLE MOSQUITO REPELLER HOME TECHNICAL SPECIFICATIONS

Reference: R-107  
 Coverage area: 25 m<sup>2</sup> | 269 sq. ft. (Indoors)  
 Battery: 4 x AAA (not included)  
 Duration (battery): 3 months (24h/day)  
 Size (mm): 50 x 50 x 50  
 Free of chemicals: No refills



### FLY REPELLER HOME



### PIGEON & OTHER BIRDS REPELLER PRO



# Safety Reflector

[www.safetyreflector.fi](http://www.safetyreflector.fi)

COREFLECT®



..and more

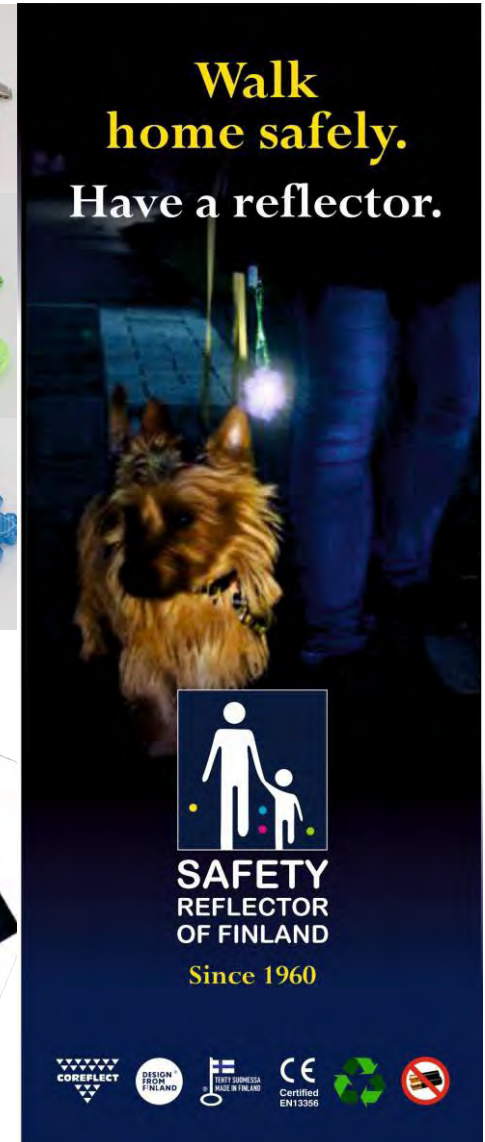



# Softreflector

[www.softreflector.com](http://www.softreflector.com)

## REFLECTING AND GLOWING STICKERS

**SHOW YOUR MOODS!**

# EMOJI!

**Rückstrahler In Love RH-001.10**  
**Rückstrahler Glad RH-001.11**  
**Rückstrahler Crazy RH-001.12**  
**Rückstrahler Naughty RH-001.13**

**Armband EMOJI AB-019.1**  
**Step-Strap EMOJI SW-018.1**

**Damit Sie sicher durch die Nacht kommen!**

**Microfiber CLEANING PAD**

1. Clean the screen
2. Store on the back side of the phone
3. Handwash when dirty

**HAPPY MC-003.3**  
**ANGRY MC-003.2**  
**IN LOVE MC-003.1**  
**GRAZY MC-003.4**

**PACKAGE VIEW**

**REFLECTOR**  
**SHOW YOUR MOODS!**

**REFLECTOR**  
**SHOW YOUR MOODS!**

**CLEANING PAD**  
**SHOW YOUR MOODS!**

**CLEANING PAD**  
**SHOW YOUR MOODS!**

### HANGING REFLECTORS

CE EN 13356

All Hanging Reflectors come with two attachment types inside the package. Pin, string and a metal ball chain.

**Pilot Snoopy RH-466.1**  
**Snoopy and Flowers RH-464.3**  
**Flying Ace Snoopy RH-465.3**  
**Snoopy with Station RH-464.1**  
**Snoopy Peeking RH-458.2**  
**Woodstock RH-458.1**  
**Snoopy Comics RH-464.2**

**NEU 2017!**

**Loop Strap Swallows LS-001.5**  
**Rückstrahler Butterfly RH-794.2**  
**Rückstrahler Love RH-792.2**  
**Rückstrahler Flower RH-795.2**  
**Rückstrahler XO RH-793.2**  
**Loop Strap Crown LS-001.1**

**BE VISIBLE IN THE DARK!**

**Anzeigen Box Für 40 Produkte**

**Damit Sie sicher durch die Nacht kommen!**

Hängender Reflektor  
 Dringender Reflektor als Warnung in einem dunklen "neutrale" Produkt in all EU-weit  
 Das Modell kann jedoch neue produktive life.

- CE standard
- EN 13356 zertifiziert
- 100% recycelbar
- Made in ESTONIA

Hängender Reflektor  
 Ein quadratischer Reflektor, der in der Regel für den Einsatz in dunklen Umgebungen geeignet ist. Dieser Reflektor ist ein Produkt aus hochwertigem Folienmaterial.

- CE Standard
- EN13356 zertifiziert
- 100% recycelbar
- Made in ESTONIA

**Das RH-464.5**  
**Call RH-458.4**  
**Butterfly park RH-458.5**  
**King Thrush RH-458.6**  
**Martha RH-458.5**

**Reflective MAGNET TAGS**

**MT-029.1-D**  
 100x100 mm

ENERGY

# Ecosavers

## ShowerTimer

Kürzer duschen



2 Min. kürzer

25% weniger Verbrauch

**NUR 2 MINUTEN AM TAG**  
**KÜRZER DUSCHEN**  
**SPART WASSER**  
**UND ENERGIE**  
**UM DAS WASSER ZU ERWÄRMEN**

Beispielrechnung: verbraucherzentrale.de



# EcoSavers

## Energy Meter

- The EcoSavers Energy Meter is a high quality measuring device which gives you more control on your electricity use.
- Simply plug in the energy metre in the mains and plug the device you want to measure into the energy meter.

### EcoSavers® Energy Meter Mini



#### Display information

By pressing the MODE-button, you can switch the display to

W	Watts of energy used
V	Voltage
Total kWh	Total energy used in kWh
Total €	Totale energy used in €
€ kWh	Price of energy in € per kWh

#### Technical details:

Operation voltage:	230V~50Hz
Operation current:	max. 16A / 3.680W
Voltage working range:	200V - 276V
Voltage accuracy:	+/- 2%
Power display range:	0.1W - 3.680W
Power accuracy:	+/- 2%
Total kWh display:	0.000 kWh - 9.999 kWh
Total costs display:	€ 0,00 - € 9.999
Price display range:	€ 00.00 - € 99,99

#### Working condition:

Working Voltage:	175Vac~276Vac
Voltage Frequency:	45 - 65HZ
Working Current:	≤16A
Working Temperature:	0 ~ 50°C



### EcoSavers® Energy Meter



#### Working condition:

Operation voltage:	230Vac/50Hz
Width voltage range:	150Vac ~ 276Vac
Operation current:	max. 16A
Wattage display range:	0.0W ~ 9.999W (max. 16A/3.680W)
Voltage display range:	0.0V ~ 9.999V (max. 276V)
Current display range:	0.000A ~ 9.999A (max. 16A)
Price display range:	00.00€/KWh ~ 99.99€/KWh
Total KWH display range:	0.000KWh ~ 9.999KWh
Total cost range:	0.00€ ~ 9.999€
CO2 display range:	0.00 ~ 9.999 kg

The EcoSavers® Energy Meter is a high quality measuring device which gives you more control on your electricity use.

Simply plug in the energy metre in the mains and plug the device you want to measure into the energy meter. The energy meter gives you all the important information, like energy consumption in kWh and EUR/currency, energy use at this moment (Watt), measuring time etc.

Measuring = knowing. This product contributes to the awareness of energy use and gives you exact information about the use of energy, so you can decide how to save energy.



# Energizer Powerbanks

<https://www.energizer.com/>

## Power Station



### PPS240W2



#### SPECIFICATIONS

Model Name : PPS240W2

Battery : Lithium iron phosphate

Capacity : 12.8V, 230.4Wh(Max.)

DC Input : 16V/3A

AC Output : 220Vac/50Hz 150W(Max.)

DC Output X 2 :12V/10A (10A Max)

USB Output X 1 :5V/2.4A

USB Output X 1 : 5V2.4A 9V2A 12V 1.5A

USB C Output X 1: PD60W 5V3A 9V3A

12V3A 15V3A 20V3A

Solar Panel Input :15~20V 48W

Dimensions : 202 ( L ) x 168 ( W ) x 130 ( H

) mm

Weight: 4000+/-100g

#### FEATURES

- Excellent gear to power up your life.
- Premium Battery cell.
- Ultra-Bright LED Flashlight
- MPPT technology for solar power
- High safety performance: Smart design for protecting electric circuit.
- 150W AC output
- LCD screen accurately show Battery Meter/ 12V DC indicator/ USB Output Indicator/AC Output indicator/Inside Temperature



# Njoy

## UPS



Agent on

UPS Status	
System Summary	
UPS	
Status	Normal
Information	
Configuration	Voltage: 232.1 V
Diagnostics	Frequency: 5.00 Hz
Load	
Output	
Status	Normal
Voltage	229.7 V
Settings	Frequency: 0 Hz
Load	0 %
Battery	
Status	Normal
Capacity	94 %
Voltage	27.5 V
Remaining Runtime	3hr.4min.
System	
Status	Normal



# Omnicharge

## Powerbank



### STROM FÜR ALLES, ÜBERALL

Die Omni 20+ ist eine Powerbank, die die meisten Geräte intelligent und gleichzeitig mit Strom versorgen kann. Sie kommt ausgestattet mit einem 100-W-AC-Anschluss, einem leistungsstarken 60W-USB-C-Anschluss und schnellem, zuverlässigem kabellosem Laden. Außerdem bietet sie Echtzeit-Energieverwaltungsfunktionen, mit denen Sie alles, was mit Ihrem Omni 20+ passiert, überwachen können.

- AC/DC AUSGANG
- SCHNELLLADE USB-ANSCHLÜSSE
- DC AUSGANG
- USB-C ANSCHLUSS
- KABELLOS LADEN
- 33.000 mAh
- VOLL GELADEN IN 2 STUNDEN
- PATENTIERTES SCHUTZSYSTEM
- KOMPAKTE GRÖSSE
- PASS-THROUGH AUFLADUNG

#### What You Can Charge

- LAPTOPS UP TO 3 CHARGES
- SMARTPHONES UP TO 6 CHARGES
- TABLETS UP TO 2 CHARGES
- DSLR'S UP TO 4 CHARGES
- ACTION CAMERAS UP TO 7 CHARGES
- GAMING DEVICES UP TO 3 CHARGES



### LEISTUNG FÜR PROFIS

Das Omni Ultimate bietet ein Ladeerlebnis wie kein anderes. Es vereint das Beste aus allen Omnicarge Produkten, bietet einen unvergleichlichen Funktionsumfang und eine Kapazität, mit der Sie alle Ihre tragbaren Geräte aufladen können.

- AC/DC AUSGANG
- SCHNELLLADE USB-ANSCHLÜSSE
- DC AUSGANG
- USB-C ANSCHLUSS
- VOLL GELADEN IN 3 STUNDEN
- 33.000 mAh
- WASSERGESCHÜTZT NACH IP-LEVEL IP54
- AUSTAUSCHBARER AKU-PACK
- PATENTIERTES SCHUTZSYSTEM
- PASS-THROUGH AUFLADUNG



#### What You Can Charge

- LAPTOPS UP TO 2 CHARGES
- SMARTPHONES UP TO 12 CHARGES
- TABLETS UP TO 4 CHARGES
- SPEAKERS UP TO 12 CHARGES
- ACTION CAMERAS UP TO 12 CHARGES
- GAMING DEVICES UP TO 3 CHARGES



# Powerplus

[www.powerplus.nl](http://www.powerplus.nl)

## ENERGY SAVING PRODUCTS

POWERplus  
DYNAMO - SOLAR  
LED FLASHLIGHT  
WATERPROOF



 **BARRACUDA**

POWERplus  
DYNAMO  
3 LED FLASHLIGHT



 **BLACKBIRD**

POWERplus  
SOLAR - USB POWERED  
FM RADIO - MP3 PLAYER



 **CROW**

POWERplus  
STAINLESS STEEL  
SOLAR CANDLELIGHT



 **FERRET**

POWERplus  
DYNAMO - SOLAR - USB  
24 LED CAMPING LANTERN  
USB OUTPUT



 **HIPPO**

POWERplus  
DYNAMO - AC - DC  
LED SEARCHLIGHT  
3W POWERLED



 **LION**

POWERplus  
FLICKERING EFFECT  
SOLAR CANDLE



 **NIGHTMOTH**

POWERplus  
DYNAMO - SOLAR - USB  
FM SCAN RADIO / LED LIGHT  
POWERBANK - CHARGER - ALARM



 **PANTHER**

POWERplus  
SOLAR - USB  
FLASHLIGHT - POWERBANK  
WATERPROOF 3W LED



 **SALAMANDER**

POWERplus  
WATERPROOF  
DYNAMO LED FLASHLIGHT  
EMERGENCY CHARGER



 **SHARK**

POWERplus  
DYNAMO - SOLAR  
3 LED FLASHLIGHT  
CARABINA CLIP



 **SEAHORSE**

POWERplus  
SOLAR-USB POWERED  
WATER BOTTLE LED LANTERN  
TRITAN MATERIAL



 **TUNA**



# Powerplus

[www.powerplus.nl](http://www.powerplus.nl)

## ENERGY SAVING PRODUCTS

 <p><b>ANACONDA</b> Mini Lighting &amp; Power System</p> <p>Power generation: Solar - USB Battery: Li-Ion 18650 3.7V/2.600mAh Size: 18,0 x 9,5 x 5,5 cm Weight: 384 gr EAN: 8717853704116</p> 	 <p><b>PYTHON</b> Foldable Charger Case 18V/40W</p> <p>Power generation: Solar Size: 53 x 38 x 8 cm (folded in case) Weight: 6,9 kg (incl. case) EAN: 8717853704611</p>	 <p><b>CROW</b> FM Scan Radio / MP3 Player in EVA Pouch</p> <p>Power generation: Solar - USB Battery: Li-Ion 18650 3.7V/1.200mAh Size: 19,0 x 9,5 x 5,5 cm Weight: 336 gr EAN: 8717853704635</p> 
<p><b>CAMEL</b> Solar Charger 3W</p> <p>Power generation: Solar Size: 21,5 x 12,5 x 2cm Weight: 190 gr EAN: 8717853703898</p> 	<p><b>JAGUAR</b> Powerbank - Speaker - Pouch</p> <p>Power generation: Solar - USB Battery: Li-Po 3.7V/800mAh Size: 18,5 x 10 x 4,8 cm Weight: 290 gr EAN: 8717853702778</p> 	
 <p><b>COLIBRI</b> Charger Powerbank / Mini Lighting</p> <p>Power generation: Solar - USB Battery: Li-Po 3.7V/800mAh Size: 9 x 4,5 x 1,2 cm Weight: 110 gr EAN: 8717853702653</p> 	 <p><b>TIGER</b> Charger 5W - 5V &amp; 12V Output</p> <p>Power generation: Solar Size: 18,4 x 15 x 4,2 cm Weight: 302 gr EAN: 8717853703379</p>	 <p><b>STORK</b> DAB+FM Radio in EVA Pouch</p> <p>Power generation: Solar - USB Battery: Li-Ion 3.7V/800mAh Size: 15 x 10 x 5 cm Weight: 360 gr EAN: 8717853704383</p> 
<p><b>CROCODILE</b> Solar Charger 5W / Powerbank</p> <p>Power generation: Solar - USB Battery: Li-Ion 18650 3.6V/1100mAh Size: 32 x 17 x 4cm Weight: 620 gr EAN: 8717853704741</p>  	<p><b>ZEBRA</b> Powerbank / LED Light</p> <p>Power generation: Solar - USB Battery: Li-Ion 3.7V/2.000mAh Size: 6,5 x 3,8 x 2,3 cm Weight: 62 gr EAN: 8717853703960</p> 	<p><b>TOUCAN</b> MP4/MP3 Player</p> <p>Power generation: Solar - USB Battery: Li-Ion 3.7V/620mAh Size: 8,8 x 5 x 1,7 cm Weight: 72 gr EAN: 5080087090559</p> 

# Sangean

[www.sangean.eu](http://www.sangean.eu)

## DAB+ / FM Multi-Powered Radio

- Powered by Hand Crank / Solar Panel / DC-in to rechargeable Lithium Battery
- Pretty Darn Tough
- Last Line of Defense
- Built-in Speaker, Clock & Headphone Jack
- Safe & Sound
- Bright LED Light



# Sandberg

## Hand-Crank-Powerbank

- 20000 mAh
- Handcrank
- LED lamp and flashlight
- Charge multiple devices
- Supports power through



## Privat Solar Power



**Solar Charger 10W / 2 x USB**  
 Artikelnr.: 420-69

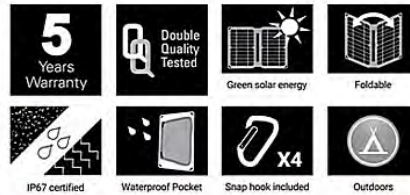

Solar panel output: 10 W / 6.3 V  
 Solar cell: Monocrystalline. High efficiency 22% transfer rate  
 Connectors: 2 x USB A female 5 V / 1 A  
 USB Output: 2 x 5V/1A (Total 10W Max)  
 Dimensions (unfolded): 32.5 x 25.2 x 0.3 cm  
 Dimensions (folded): 16.1 x 25.2 x 1.8 cm  
 Weight: 0.36 kg

Lieferumfang:  
 1 Sandberg Solar Charger 10W 2 x USB  
 4 Snap hooks, 1 Quick guide



**Solar Charger 21W / 2 x USB**  
 Artikelnr.: 420-70



Solar panel output: 21 W / 7.6 V  
 Solar cell: Monocrystalline. High efficiency 22% transfer rate  
 Connectors: 2 x USB A female 5V / 2A  
 USB Output: 2 x 5V/2.1A (Total 21W Max)  
 Dimensions (unfolded): 53.9 x 27.8 x 0.3 cm  
 Dimensions (folded): 19.6 x 27.8 x 3.1 cm  
 Weight: 0.68 kg

1 Sandberg Solar Charger 21W 2xUSB  
 4 Snap hooks  
 1 Quick guide

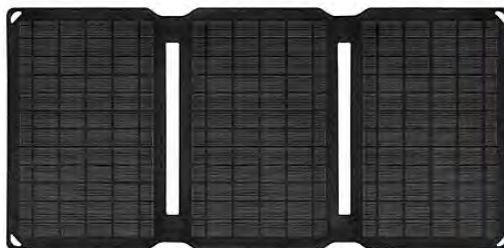

**Solar Charger 40W / QC3.0+PD+DC**  
 Artikelnr.: 420-67

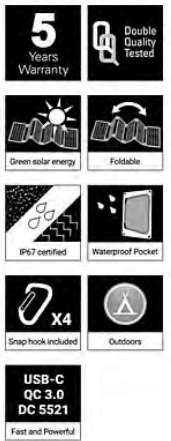

Solar panel output: 40W  
 Solar cell: Monocrystalline, High efficiency 22% transfer rate  
 Connectors: 1 x USB-A QC 3.0 female, 1 x USB-C, 1 X DC 5521  
 Dimensions (unfolded): 124 x 28.2 x 0.3 cm  
 Dimensions (folded): 20,7 x 28.2 x 4.4 cm  
 Weight: 1.4 kg

Lieferumfang  
 1 Sandberg Solar Charger 40W QC3.0+PD+DC  
 4 Snap hooks  
 1 Quick guide

# Xtorm

## Portable Power Stations

- Hours of Power
- Recharge in 4 ways
- Universal Compatibility

Provide your fishing trip, working weekend, festival or camping trip with **MoreEnergy**

**1.5d** a LED light 30W  
**12.5h** a small TV 30W  
**9.5h** a small coffee 40W  
**13h** a small coffee 40W

4PIN CHP  
 CHARGE 9 DEVICES  
 PASS THROUGH CHARGING

\* Via 12V Carling output.

The freedom of AC power. Anywhere you go.

2x AC (MAX) 500W/220V  
 1x USB-C PD 60W  
 2x DC 5.5V/5A 60W  
 1x USB QC3.0 18W  
 2x USB 18W  
 1x 12V CAR 120W

**BIG PORTABLE POWER STATIONS**

XP300U XP500

**Recharge in 4 ways**  
 Even when recharging, you can still use all the outputs.

WALL SOCKET  
 VIA USB-C PD  
 VIA SOLAR PANEL  
 VIA 12V CAR CHARGER

\*1x Power Station comes with a PCIe Smartwire Cable for Solar Panels. Solar Panel not included.

**300W Off-Grid Power**  
 The Freedom of AC Power. Anywhere you go.

300W OUTPUT  
 78,000 mAh BATTERY  
 1 BUILT IN AC SOCKET

300W / 240W AC Output  
 78,000mAh Capacity

**In the Box**  
 Discover the Xtorm experience.

User Manual  
 Xtorm Support Headset  
 1x PC4  
 1x MC4 to DC 6,5mm converter cable  
 1x AC Adapter, 1 Power Cable  
 1x Power Station 300

SUPPORT XTORM EU  
 SOCIALS XTORM



WELLNESS, WEATHER, WATCHES

# ArmourLite

[www.armourlite.com](http://www.armourlite.com)

## WATCHES PROFESSIONAL SERIES



### ArmourLite Professional Series (2nd Generation)

Shatterproof Armourglass Crystal

Steel Bands



AL1401



AL1402



AL1403



AL1404

Rubber Bands



AL1411



AL1412



AL1413



AL1414

# ArmourLite

[www.armourlite.com](http://www.armourlite.com)

## WATCHES FOR ACTIVE PEOPLE

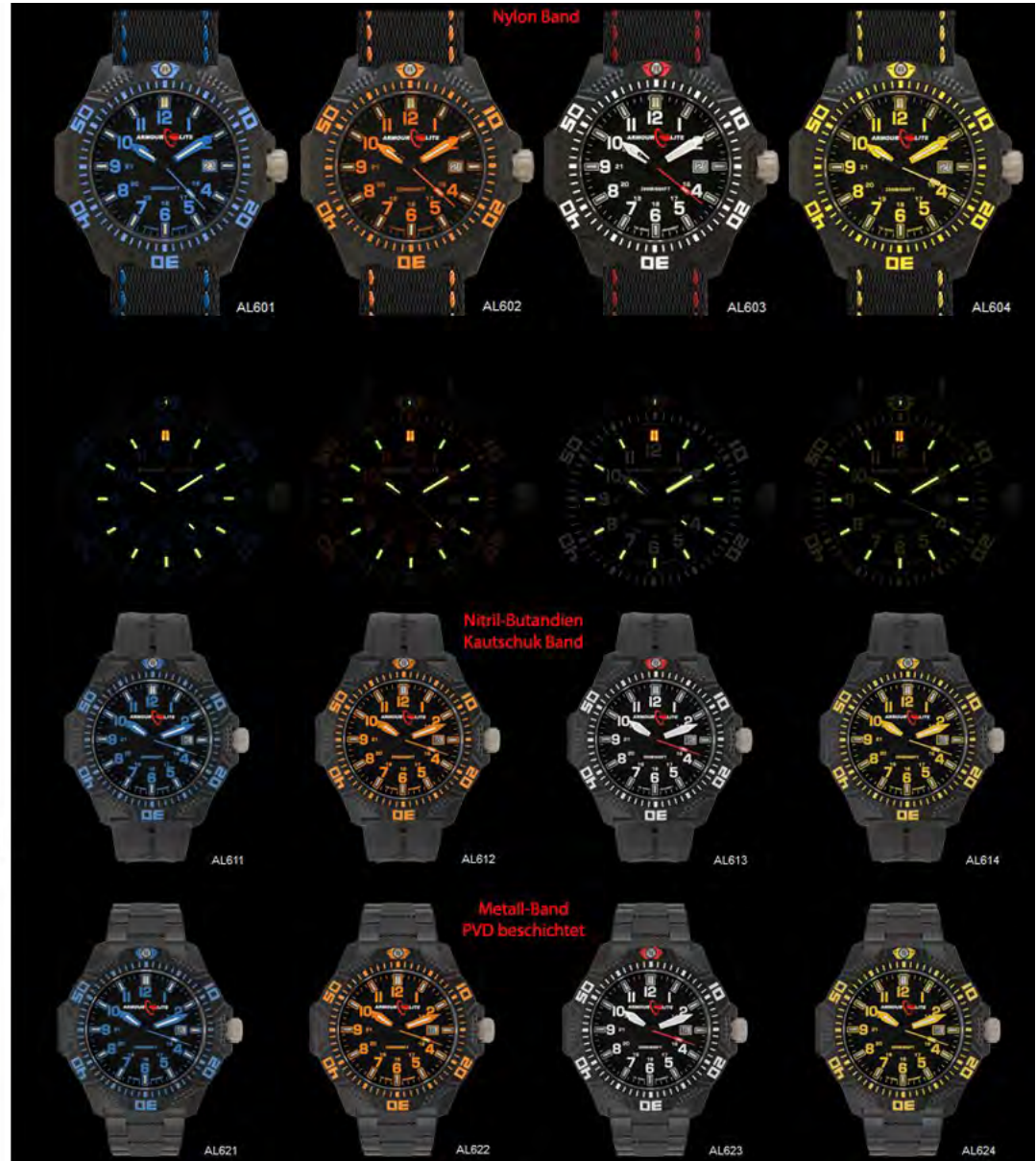



# ArmourLite

[www.armourlite.com](http://www.armourlite.com)

## WATCHES FOR ACTIVE PEOPLE

ArmourLite Alarm Clock Pocket Watch ALPW02



ArmourLite Alarm Clock Pocket Watch ALPW01



### Specifications

Movement: Alarm clock movement

Features: Date & alarm clock function

Crystal: Anti-reflective scratch-resistant sapphire crystal

Case Material: 316L Stainless Steel

Case Color: Stainless Steel

Case Diameter: 46mm

Case Thickness: 12.8mm

Crown: Push

Bezel: Stationary

Dial Color: White

Hands Color: Black & red

Tritium Markers: Green and orange  
T25 Swiss tritium markers

Water Resistance: Dustproof Only

Battery: 60-months

Warranty: 2 years

# Atmotube

[www.atmotube.com](http://www.atmotube.com)

## PERSONAL AIR QUALITY COACH – ATMOTUBE PRO

# ATMO<sup>®</sup> TUBE

**PRO**



Our most advanced solution for both indoor and outdoor air quality tracking. It detects PM1, PM2.5, and PM10 pollutants, such as dust, pollen, soot, and mold spores. It can also measure VOCs concentration, atmospheric pressure, temperature, and humidity - all in real time!



### How it works









The sensors inside Atmotube keep constant track of air parameters and send the data to your mobile phone via Bluetooth Low Energy (LE).

The Atmotube mobile app is free and available for iOS 9 and Android 4.3+ smartphones with Bluetooth LE support.

If the air quality gets below certain point, you will immediately receive an alert notification.

You can access all your measurements, an air quality map, and your personal air score from your mobile phone, which will help you to make the right choices and live healthier.

For PM1, PM2.5, and PM10, readings on Atmotube Pro just press the button one time to start measuring the (PM1, PM2.5, PM10) pollution.

-   
VOLATILE ORGANIC COMPOUNDS
-   
PARTICULATE MATTER 1µg
-   
PARTICULATE MATTER 2.5µg
-   
PARTICULATE MATTER 10µg
-   
HUMIDITY
-   
TEMPERATURE
-   
ALTIMETER
-   
ATMOSPHERIC PRESSURE

### Comparison

	 PLUS	 PRO
PM SENSOR		✓
BAROMETER/ALTIMETER	✓	✓
TEMPERATURE	✓	✓
HUMIDITY	✓	✓
HARMFUL GASES & VOCs SENSOR	Upgraded MEMS TVOC + gases sensor with automatic calibration	Upgraded MEMS TVOC + gases sensor with automatic calibration
BLUETOOTH	Bluetooth 5.0, improved antenna performance	Bluetooth 5.0, improved antenna performance
BATTERY LIFE	7 days	7 days if PM sensor is used about 10 times a day for 10-15 minutes

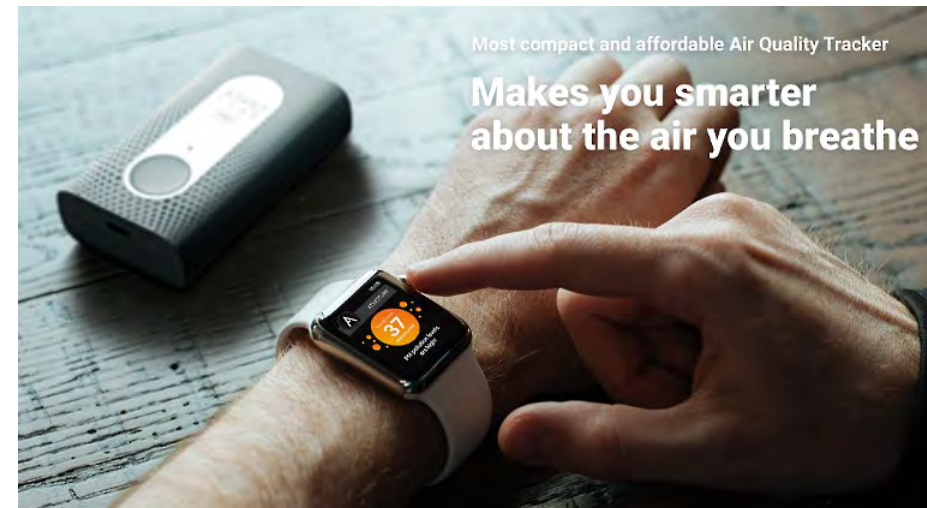

Most compact and affordable Air Quality Tracker

## Makes you smarter about the air you breathe

# Balmuda

[www.balmuda.com](http://www.balmuda.com)

## THE GREENFAN



**BALMUDA**  
The GreenFan

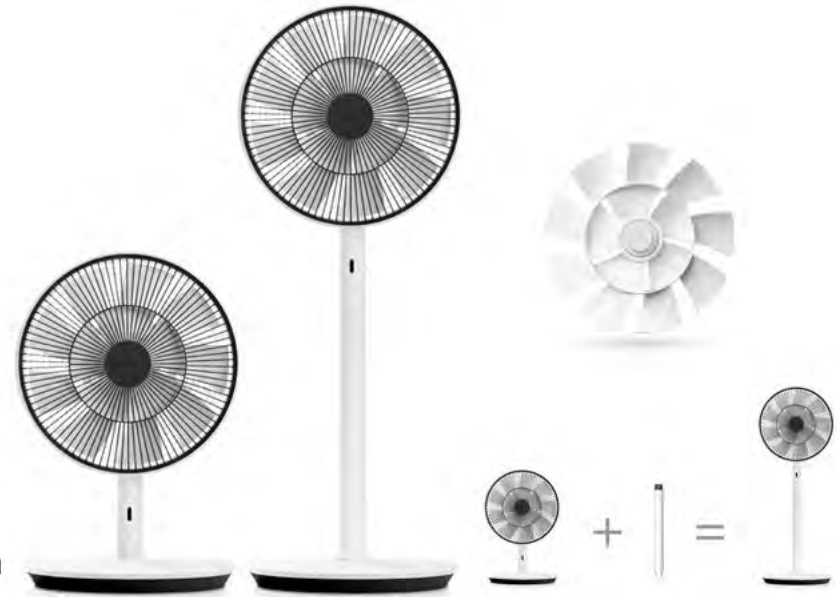

GreenFan Airflow

- 1.5 W Energy consumption (in low mode)
- 13dB Noise Level (in low mode)
- Free Oscillating angle from 30° to 150°
- Remote controller
- Made in Japan



Einstellung des Schwingungswinkels im Bereich ist verfügbar

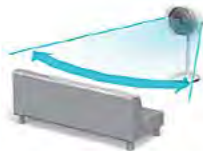

Breiter Schwenkbereich für den gesamten Raum



Enger Schwenkbereich für Ihren Sitzplatz



**GreenFan Cirq**

GreenFan has the air circulator reinvented

15m

3w



# Bimar

## FANS

- RIGHT/LEFT OSCILLATING
- ADJUSTABLE HIGH / LOW
- 3 SPEED
- 3-BLADE
- PLUG & PLAY
- FLEXIBLE EVA BLADES



- Zzri SLEEP FUNCTION
- PURIFICATION FUNCTION
- NATURE FUNCTION
- REMOTE CONTROLLER INCLUDED
- CONTROLS WITH LED LIGHT
- 7.5 H TIMER
- NANOCELLULOSE FILTER
- 2 PACKAGES OF ICE
- 3 SPEED
- 4L TANK



# Canyon

[digital.canyon.eu](http://digital.canyon.eu)

## Smart Watches



# DENVER

## SMART WATCHES



# DENVER

[www.denver-electronics.com](http://www.denver-electronics.com)

## SMART WATCHES

### DENVER SW-500

With GPS  
Bluetooth smartwatch with GPS function for running, biking etc.  
1.3" IPS display - perfect for showing notifications, calls etc.  
IP-66 water splashproof



### DENVER SW-450

Basic  
Bluetooth smart watch with built-in heartrate sensor  
1.3" IPS display, track your sport, get notifications, sms, email etc. on watch, take calls on the watch



### DENVER BFH-14

Basic  
Fitnessband with heartrate monitor & colour display  
Track your activity & sleep. Free app for Android and iPhone.



### DENVER BFA-15

Basic  
Fitnessband with Bluetooth 4.0 function  
Free app for Android and iPhone.



## KIDPHONE WATCHES

**ELARI KidPhone 4G**   
Created for kids



New children's 4G watches with Camera, bright Red or strong Black colors of straps and IP67 class of protection

- Up to 4 non stop working days;
- GEO-fence;
- GPS/Wi-Fi/Bluetooth;
- Build in Camera;
- Water\* and dust resistant;

By installing the Elari SafeFamily app on their smartphones, parents will be able to:

- Customise the watch contact list
- Track the kid's location
- Set the geolocation update frequency
- Set the alarms remotely
- Listen to what's going on around the child through the remote audio monitoring function
- Set the allowed geo zones, i.e. virtual areas around your child's habitual locations (kindergarten, school, etc.). Parents will be notified if the child leaves the safe geo zone
- Invite family members or authorized people to track the child's location and exchange voice messages
- Receive SOS notifications from the watch in case of emergency: together with the alarm signal, parents will get data on the child's current geolocation and an audio recording from the watch's microphone
- As well as many other options!

**ELARI KIDPHONE 2**  
KIDS' WATCH-PHONE WITH GPS/GLONASS/LBS TRACKING, BRIGHT TOUCHSCREEN AND VOICE CHAT



**ELARI KIDPHONE 3G**  
KIDS' 3G WATCH-PHONE WITH GPS/LBS/WIFI TRACKER AND VIDEO CALL FUNCTION



- Video call function
- Colorful high resolution touchscreen
- 2 MP front camera
- Two-way voice communication
- Voice monitoring, safe zone function
- GPS/LBS/WiFi tracking
- SOS function with dedicated button
- IP65 protection class
- Slot for nanoSIM card
- GPRS Class12
- Bluetooth 4.0
- G-sensor
- Emoji
- Class time mode, alarm clock, voice chat with photo, pedometer



# G3Ferrari

## FANS



# GeoSmartPro

[www.geosmartpro.com](http://www.geosmartpro.com)

## Smart Fans – AirGo und AirLit



**GeoSmartPro**  
**AirGo Smart Fan**  
 Go with the flow, the smart way

Ok Google, Turn on the Fan!

works with the Google Assistant!

AirGo Smart Fan can be controlled via the free GeoSmartPro app from anywhere, anytime.

Feature-packed app, allowing users to adapt all their GeoSmartPro products to their lifestyle.

Compatible with leading voice assistance: **Amazon Echo and Google Home.**

Speed, Oscillating, Timer, SmartHub, Sleep, Customization

Available on the App Store and Google Play.



**AirLit**

- SMART RING LIGHT
- SMART FAN
- MIRROR
- PORTABLE

Ok Google, turn the AirLit on!

GeoSmartPro is proud to announce AirLit. The UK's 1st all in one, a smart fan, ring light and mirror.

Fitting into your lifestyle seamlessly. The smart companion for your live streaming, work from home or makeup.

The feature-packed GeoSmartPro app gives you complete control over your figure tips!

4 speeds, 3 colors, Magneto Mirror, Hand free Phone Holder, Rechargeable Portable, Sensors, Touch Control

# Lenovo

## Smart Watches

**LENOVO E1PRO**  
**MAKE GOOD TIMES BETTER**



**BLUTDRUCK & BLUTSAUERSTOFF MONITORING**  
 24 Std. HERZ- & SCHLAF-MONITORING  
 1,4" / 3,6cm FULL TOUCH HD SCREEN  
 3 ATM / IPX68 WASSERDICHT



### Lenovo E1 Pro Sport Smartwatch

#### Blutdruck und Sauerstoffsättigung

2 spezielle Funktionen zur Überwachung Ihrer Gesundheit mit genauer Analyse weiterer Körperparameter

**BLUTDRUCK & BLUTSAUERSTOFF MONITORING**



97%  
LOADING...

110/68  
LOADING...

Lenovo R1  
**Global 1st**  
**DIY**



**Lenovo**

**Lenovo R1 SMART WATCH**

**Multi-strap to choose**  
 1.3" big colored screen with Full touch  
 7H toughened glass lenses  
 24H continue heart rate monitor  
 IP68 Waterproof  
 Normal use time 7-10days  
 Standby time for 30days

Screen type:	TFT
Screen size:	1.3" all touch screen
CPU:	Nordic 52832
Bluetooth version:	Bluetooth 4.0
Waterproof:	IP68 WaterProof
RAM:	64KB
ROM:	512KB
Battery capacity:	280mAh
Battery type:	Lithium Polymer Battery
Using time:	7-10 days
Charging time:	About 2-3hours
Standby time:	30 days
Strap material:	Silicone/ Steel strap
Strap colour:	black/ Black + Green/ Black Milanese
Case colour:	black
Compatibility:	Android 4.4 and iOS 8.0 and above
Functions:	Alert type, Smart reminder, Health tracker, Message
Retail box size:	16*16*3cm
Product weight:	0.231kg







# Marathon

[www.marathonwatch.com](http://www.marathonwatch.com)

Zeit und Wetter



# NASA

## Zeit und Wetter



# Platinet

## Ventilatoren + Pocket Fans



**16" STAND FAN**

**40W**

Model: PSF1616B

- 3 Speed Adjustable
- Right and Left Oscillation
- Mesh Grill
- Power 40W



**45 cm**

**140 cm**

Model: G50037

- 3 Speeds
- Automatic oscillation
- Metal Body
- 50W Motor
- Adjustable height



**NIGHT LIGHT**

**DESK FAN**

10 Hours of Work  
3 Speed Levels

PRDF0326



**MOBILE DESIGN**

**POCKET FAN**

4 Hours of Work  
Micro USB Connector  
Stylish Design

BUILT-IN BATTERY  
1200mAh

micro USB

**Pocket fan with built-in battery**  
The powerful 1200mAh battery allows 4 hours of fan operation. The device's battery is charged with a microUSB connector, thanks to which the fan can be charged with the same cable and charger that is used to charge smartphones.

**TECHNICAL SPECIFICATIONS**

- Battery: 1200mAh,
- 3.7V lithium ion
- Charger: 5V/1A (not included)
- Working time: up to 4h (fan)
- LED status indicator
- MicroUSB connector

PRDF6108

# Platinet

## Air Diffuser

### USB AIR HUMIDIFIER

Compact Construction

Efficiency 20ml/h  
Capacity 250ml

PAHCZ01

#### USB AIR HUMIDIFIER

Changes the water into a fine mist providing fresh and humidified air. The moisturizing effect is visible in the form of a fine mist coming out of the device nozzle. Maintaining the proper air humidity by applying a humidifier cleanses and refreshes the air in the rooms in which it is located.

#### Product features

- 250ml capacity
- efficiency 20ml/h
- weight 165g
- compact construction
- safe to use
- Improves well-being and psychophysical fitness
- automatic protection against water shortage



### OZONE AIR PURIFIER

Working Time Up To 15h

Ozone Emission: 5 mg/h  
Emitted anions:  $5 \times 10^3$  pcs/m<sup>3</sup>  
Coverage:  $\leq 0.35$ m<sup>3</sup>



### ULTRASONIC DIFFUSER

PADYM025

Humidifier and Air Ionizer

Essential Oil Diffuser  
Colorful LED Lighting  
Efficiency 30ml/h  
Capacity 500ml

#### ULTRASONIC DIFFUSER

Turns the water into a fine mist, acting as a humidifier and air ionizer. After adding only a few drops of your favorite fragrance oil to the water, it becomes a fragrance diffuser, which in combination with a delicate colored light will create a relaxing atmosphere in every room. Built-in LED backlight and a modern look make it fit in any interior.

#### Product features

- weight 395g
- efficiency 30ml/h
- 500ml capacity
- colorful LED lighting 7 colors
- working modes: continuous or intermittent
- for use with fragrance oils and with natural essential oils
- low energy consumption
- automatic protection against water shortage

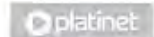

# QuietOn

[www.quieton.com](http://www.quieton.com)

## ACTIVE NOISE CANCELLING EARPLUGS



## Technologie

Die Geräusche in Flugkabinen liegen bei etwa 100Hz. Bei dieser Frequenz versagen alle passiven Ohrstöpsel. Sie wirken zwar breitbandig, decken aber niedrige Frequenzen nicht ab. QuietOn vereint beide Eigenschaften. Sowohl die passive breitbandige Lärmunterdrückung als auch die aktive Lärmunterdrückung im niedrigen Frequenzbereich.

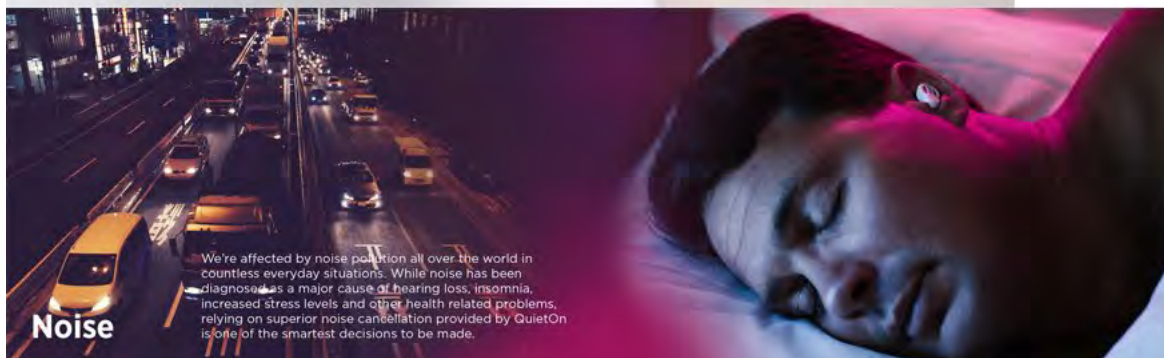



# QuietOn

[www.quieton.com](http://www.quieton.com)

## ACTIVE NOISE CANCELLING EARPLUGS

### Reisen

- Schalten Sie auf anstrengenden Flugreisen einfach ab.
- Ausgeruht ins Meeting
- Effizientes Arbeiten in Bahn oder Flugzeug
- In Hotels ruhig schlafen



### Arbeiten

- Verbesserte Leistung durch Vermeidung von Ablenkung.
- Stress reduzieren
- Unkomfortablen Gehörschutz durch kleine, leichte QuietOns ersetzen



### Produktbeschreibung

- Der einmalige QuietOn verschafft Ihnen Ruhe durch aktive Rauschunterdrückung und akustische Geräuschdämpfung



### Funktion

- Der QuietOn arbeitet auf dem gleichen Niveau wie die besten On-Ear-noise cancelling Kopfhörer
- 50 Stunden Akkulaufzeit



# Riversong

## Smart Watches

[www.riversongtech.com](http://www.riversongtech.com)



- Dial Customization
- Heart Rate Monitor
- Daily Activity Tracking
- Blood pressure Monitor
- Blood Oxygen Monitor
- Sleep Monitor
- Call and Message Notification
- Weather Forecast
- Multisport Mode
- Luxury Metal Case
- Colorful Touch Screen

#### SPECIFICATION

Model: SW10  
 Display: 1.28" IPS Color Screen  
 Battery Capacity: 220mAh  
 Material: Metal (with tempered glass cover)  
 Usage Time: Up to 10 days  
 Waterproof: IP68



#### FEATURES

- Full Touch Screen
- Multiple Watch Face
- Slim & Premium Design
- Dynamic Heart Rate Monitoring
- Daily Activity & Sleep Tracker
- Blood Pressure Monitor
- Blood Oxygen Monitor
- Call/SMS/SNS Notification
- Weather Forecast
- Multi-sport Mode

#### SPECIFICATION

Modell: SW09  
 Chipset: Nordic 52832  
 Display: 1.4" IPS color screen  
 Navigation: Touch screen  
 Battery Capacity: 170mAh  
 Usage Time: up to 10 days  
 Water Resistant: IP67

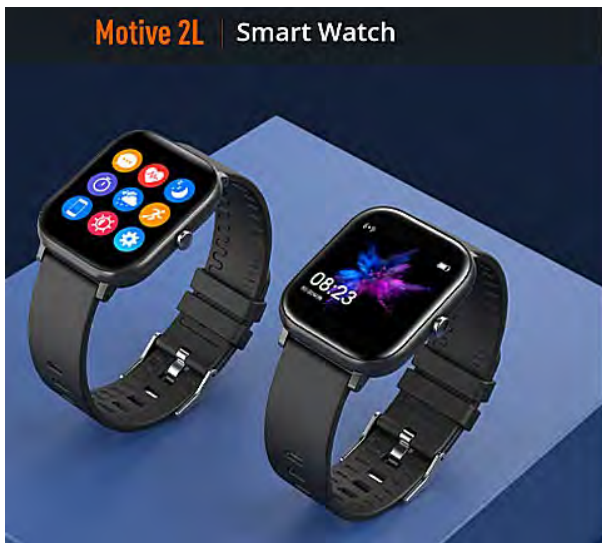

- Amazing Animated Wallpaper
- 1.4" HD Touch Screen
- Health Monitor
- Daily Activity Tracking
- Heart Rate Monitor
- Blood Pressure Monitor
- Blood Oxygen Monitor
- Sleep Monitor
- Call/SMS/SNS Notification
- Weather Forecast
- Multisport Mode

#### SPECIFICATION

Model: SW18  
 Display: 1.4" Full Color Screen  
 Resolution: 320\*320  
 Waterproof: IP68  
 Material: Polycarbonate+2.5D tempered glass  
 Usage Time: 5-7 days

## Wave S | Smart Fitness band



#### FEATURES

- Blood pressure & blood oxygen monitor
- Dynamic HR monitor
- 0.96" TFT color screen
- Multi-sport mode
- Convenient charging (built-in USB)

#### SPECIFICATION

Model: F111  
 Main Chip: Dialog 14585  
 Screen: 0.96" TFT screen  
 Battery: 90mAh  
 Battery life: 5-7 days  
 Charger: In-built USB charger  
 Waterproof: IP67  
 Color: ● Black ● Blue ● Red

## Gun Massager



### What's a fascia gun?

Fascia gun is an intensive muscle fascia impactor that generates high-frequency vibrations penetrating deep into the muscles.

### What does a fascia gun do?

By means of high-frequency vibration, a fascia gun relaxes tight muscles, helping to alleviate the soreness, swelling and pain in muscles; prolonged use helps to build muscles and restore muscle vitality.

Intensive Relaxing Massage

Using the SKG Fascia Gun

Ergonomic design

Easy relaxation

T-pattern center of gravity

Omni-directional dual handle

### 4 massage heads for body relaxation



#### Spherical head

For massage relaxation of big muscle groups



#### Flat head

For shaping & fitness massage



#### Bullet head

For deep tissues impact for intensive massage



#### U-shaped head

Strong stimulation for small muscle groups

# Trevi

[www.trevi.it](http://www.trevi.it)

## OLD TECH WATCHES



SILENT  
QUARTZ

### OM 3507 S

- SWEEP silent move
- Continuous seconds
- Gummy finish
- Relief numbers
- Metal lancets
- Diameter 28 cm



### RC 855 C

- Radio band FM PLL
- 20 radio channel preset
- Digital frequency indication
- Display 0,6" LED
- Dimmer
- 2 programmable radio/alarms
- Sleep function
- AUX IN Ø 3,5mm
- Smartphone connectivity
- Snooze
- Anti blackout port (2x AAA not included)
- Power supply: 5V 1,5A
- 110-240V ~ 50/60Hz
- Dimensions: 100 x 100 x 100 mm



### SLD 3068 S

- 12h/24h Alarm clock
- Calendar / Thermometer
- Rubber finish
- Automatic light sensor
- Big LCD display / Light
- Snooze function
- Backlight LED display
- Power supply: 2 Batteries AAA not included
- Dimension: 132 x 76 x 46mm



### SLD 3860

- LCD display LED backlight
- 12/24h clock
- Thermometer °C/°F
- Multilanguage calendar
- Temperature
- Calendar
- Snooze
- Power supply
- Dimensions: 78 x 78 x 30 mm



### SLD 3865

- Big display LCD
- Soft finish case
- Color backlight display
- Clock 12-24h
- Easy alarm turn on
- Direct view alarm
- Snooze function
- Power supply: 2 x AAA (not included)
- Dimensions: 80x80x62 mm

### SLD 3870

- Big Display LCD
- Rubber finish
- Backlight display in assorted colors
- Simple set alarm clock direct input key
- Snooze
- Power: 3 batteries "AAA" (not included)
- Dimensions: 140 x 68 x 50 mm



### SL 3825

- Big dial scale
- Bright led hours indications
- Automatic light sensor (when the place gets dark lights automatic backlight LED display and vice versa)
- Tasto Snooze/Light
- Electronic alarm with Crescendo
- SWEEP Silent move
- Power supply: 1 AA battery
- Dimensions: 100 x 100 x 43 mm



# Trevi

## DESIGN CLOCKS

[www.trevi.it](http://www.trevi.it)



### EC 883 BL

- » Big display with white LED
- » Mirror front finish
- » Touch controls
- » Clock 12-24h / Thermometer °C-°F
- » Electronic ringtone
- » Snooze function
- » Dimmer function
- » Power supply: 3 x AAA not included
- » Power 5V 1A / 100-240V-50/60Hz power adaptor included
- » Dimensions: 190 x 45 x 76 mm



Lifestyle  
technology

### SL 3840

- » Natural wood chassis
- » Large dial
- » Bright led hours indications
- » Button Snooze/Light
- » Electronic alarm with Crescendo
- » SWEEP Silent move
- » Power supply: 2 AA battery
- » Dimensions: 94 x 95 x 42 mm



Lifestyle  
technology

### SL 3841

- » Natural wood chassis
- » Large dial
- » Bright led hours indications
- » Button Snooze/Light
- » Electronic alarm with Crescendo
- » SWEEP Silent move
- » Power supply: 2 AA battery
- » Dimensions: 94 x 95 x 42 mm

## BIG COLOR WEATHER STATION



The advertisement features a large black weather station with a multi-colored LCD display. The display is divided into several sections: a forecast section with icons for sun, clouds, and rain; an outdoor temperature section showing 26°C and 45% humidity; an indoor temperature section showing 25°C and 52% humidity; a calendar section showing the date 28/7; and a time section showing 11:23. To the right of the main unit is a vertical external sensor. Below the main unit is a 'RADIO CONTROLLED' icon. The background is a light purple wall with a hat hanging under a 'SUN' sign and a yellow raincoat hanging under a 'RAIN' sign. To the right, there is a list of features for the 'Trevi ME 3165 RC' model. In the foreground, there are several small icons representing different weather conditions: sun, clouds, rain, and a digital display showing '1012 HPA'.

**Trevi ME 3165 RC**

- » Big color LCD display
- » 12/24h radiocontrolled clock / calendar
- » hPa barometer with atmospheric pressure indication
- » Record daily temperature and wet min/max
- » 2 programmable alarm-clock with SNOOZE
- » °C/°F indoor/ external digital thermometer
- » Indoor / external hygrometer
- » Wireless external sensor
- » Icons for the weather forecast indication
- » Power supply unit: 3 batteries AAA (Batteries not included)
- » 230V 50Hz / 5V 0,15A
- » Power sensor: 2 batteries AA (Batteries not included)

# Ulla – Hydration Reminder

[www.ulla.io](http://www.ulla.io)

NEVER FORGET TO DRINK WATER AGAIN



- Fits on any water bottle
- Detects when you hydrate
- Blinks if you forget to drink

HEALTH



## Temperatur-Messgeräte



Modell 538400 (mit erweiterter Display-Anzeige)

### KONTAKTLOSE TEMPERATUR-MESSUNG:

Einfach 5 bis 10 cm vor das Gerät stellen und die Messung erfolgt automatisch innerhalb von nur einer Sekunde. Perfekt als Eingangskontrolle

### MONTAGEFERTIG:

Im Lieferumfang enthalten ist doppelseitiges Klebeband zur Anbringung an glatten Oberflächen. Alternativ sind Ösen und eine Aufhängung für Nägel vorhanden.

### MIT USB-ANSCHLUSS:

Das Thermometer wird einfach über den Standard -USB-Anschluss an das Stromnetz angeschlossen und kann so auch ohne die enthaltene aufladbare Batterie betrieben werden

### VIELSEITIG EINSETZBAR:

Perfekt zur Kontrolle von Mitarbeitern - z.B. in Supermärkten, Schulen, Universitäten, Altenheimen, Friseursalons usw.

### ACE-GARANTIE:

5 Jahre ACE-Deutschland-Garantie auf den hochpräzisen Infrarot-Sensor!



Modell 538265 (mit XXL-Messwertanzeige)

### IDEAL FÜR SCHNELL- UND MASSENKONTROLLEN

Mit dem ACE Infrarot-Thermometer messen Sie kostengünstig eine große Zahl an Personen. Die maximale Abweichung beträgt dabei nur 0,2 °C.

Für den Einsatz im Ausland kann die Messeinheit auf Fahrenheit umgestellt werden.

1S

Quick Measurement

±0.2

High Accuracy

Alarm Function

Alarm Function

1W

One Week Standby

°C/°F

°C/°F Unit Available

Energy Saving

Energy Saving

## Air Purifier

- Airfree devices destroy  
Viruses, Bacteria, Pollen  
Organicodurs,  
Pet dander allergens  
Mould, Dust mite allergens,  
Ozone.

### Airfree Technology User-friendly Technology

Just like your grandmother used to do, Airfree “boils” the air, destroying all microorganisms. Airfree technology is not only safe and easy to use, but it also relies on a totally natural process.

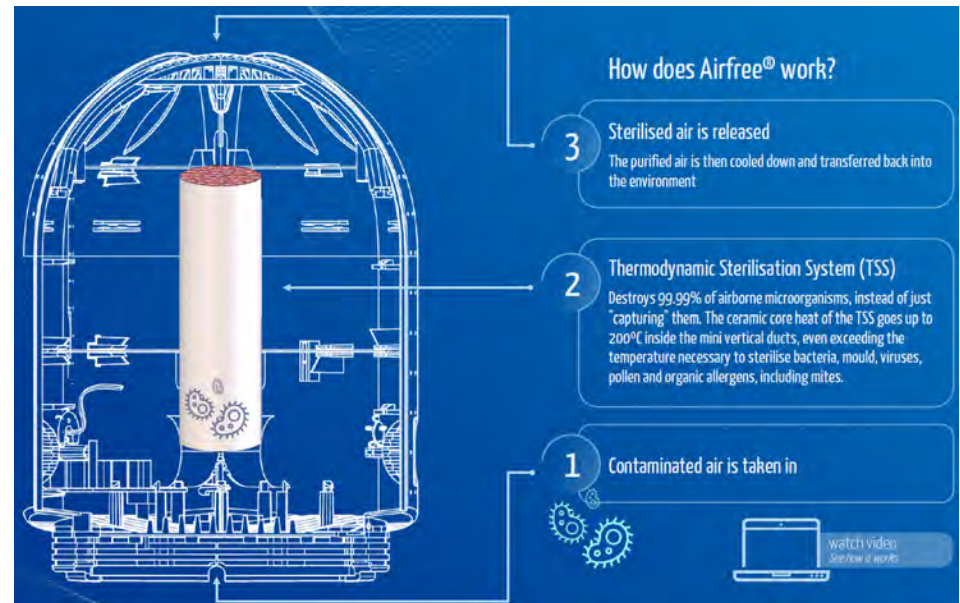

# Air-Next

[air-next.eu](http://air-next.eu)

## Luftfilter



<https://air-next.eu/nasa/>

### Ursprünge in der NASA, perfektioniert von ActivePure

Die Basis der ActivePure® Technologie wurde in den 1990er Jahren von der NASA für das Space Shuttle geschaffen. Fortschritte in der Technologie haben die Effizienz ohne Verwendung von Ozon (O3) erhöht. Für diese Fortschritte wurden die Produkte als Certified Space Technology bezeichnet und sind eine von nur 75 Technologien, die in den letzten 30 Jahren in die Space Technology Hall of Fame aufgenommen wurden. Basierend auf aktiven Prozessen, die in der Natur vorkommen, ist die proaktive Pathogenabwehr das einzige ungiftige, von der FDA zugelassene System, das die Luft kontinuierlich reinigt und für Mensch und Tier sicher inhaliert werden kann.

Der proaktive Erregerschutz wurde sofort von Krankenhäusern für den Einsatz in Operationssälen und Akutziimmern übernommen. Es war von Anfang an bekannt, dass diese ActivePure-Technologie Tausende von Leben retten könnte. Es ist jetzt für jedes Zuhause, jedes Geschäft und jeden öffentlichen Raum in Amerika und Europa verfügbar.



### Das Aerus Mobile ist ideal für:

- Hotelzimmer
- Kleinere Büroräume
- Autos / Lastwagen / Busse / Taxis / Wohnwagen / Wohnmobile
- Krankenwagen
- Schlafzimmer
- Menschen mit Allergien
- Menschen mit Bronchitis und Asthma



### Der Pure & Clean ist ideal für:

- Warte- und Übungsbereiche
- Büros
- Klassenzimmer
- Einzelhandel / Geschäfte
- Gaststättengewerbe
- Pflegeheime / Pflegeheime / Krankenhäuser
- Menschen mit Allergien
- Menschen mit Bronchitis und Asthma



### Der Beyond Guardian Air ist ideal für:

- Warte- und Übungsbereiche
- Büroräume
- Einzelhandel / Geschäfte
- Klassenzimmer
- Fitnessstudios
- Gaststättengewerbe
- Pflegeheime / Pflegeheime / Krankenhäuser
- Menschen mit Allergien
- Menschen mit Bronchitis und Asthma



### Der Aerus Hydroxyl Blaster ist ideal für:

- Ausstellungsräume (Autohändler / Geschäfte)
- Konferenzzentren
- Restaurants
- Größere Geschäfte (Supermärkte)
- Fitnessstudios
- Gaststättengewerbe
- Pflegeheime / Pflegeheime / Krankenhäuser
- Menschen mit Allergien
- Menschen mit Bronchitis und Asthma

# Aquila

## Aquila disposable nitrile examination gloves

[www.aquilavie.com](http://www.aquilavie.com)

**Aquila Healthcare Limited**, a subsidiary of Hong Kong based Aquila Group Holdings, was established in early 2020 to make a positive contribution to global anti-pandemic efforts and to broaden community access to life-saving medical devices and protective equipment.

As the world transitions to a new reality with COVID-19, our commitment remains as strong as ever as we look to extend our reach to support the broader healthcare sector.

### -AQQGLOVE35 DISPOSABLE NITRILE EXAM GLOVES

#### AQQGLOVE-NIT-35

A perfect balance of tactile sensitivity and comfort, -AQQGLOVE35 is ideal for tasks which require great precision as well as durable protection. Light, form fitting with 3.7 mil thickness at the fingertips for maximum feel, -AQQGLOVE35 has been designed for comfort of professionals who need to stay in their gloves for extended periods.



- Ideal for dentists, doctors, healthcare professionals who require great sensitivity as well as protection
- Chemotherapy drug tested
- Suitable for low exposure to liquids and chemicals
- Blue color

Made of latex-free, powder-free nitrile for **strong and durable protection**

3.7 mil thickness and textured fingertips for **greater dexterity and sensitivity**

**AQUILA<sup>VI</sup>E™**  
HEALTHCARE

Ambidextrous design, beaded cuff for easy donning

Light, comfortable fit suitable for extended wear

**AQUILAVIE.COM**  
Aquila Healthcare Limited

Length (cm)	
	≥ 230
Thickness Measurement (mil)	
Finger (15mm ± 5mm from tip), Size M	≈ 0.10 (± 0.02)
Physical Properties	
Before Aging	After Aging
Tensile Strength (MPa)	≥ 14
Elongation (%)	≥ 400
Inspection Levels & AQL	
Water-tightness	0/1
Physical Dimensions	5/2
Physical Properties	5/2
Visual Inspection (Minor)	5/4
Visual Inspection (Major)	5/4
Particulate Residue	N=5

**AQUILA<sup>VI</sup>E™**  
HEALTHCARE

**THE QUALITY OF CARE.**

### -AQQGLOVE45 DISPOSABLE NITRILE EXAM GLOVES

#### AQQGLOVE-NIT-45

A perfect balance of tactile sensitivity and comfort, -AQQGLOVE45 is ideal for tasks which require great precision as well as durable protection. Light, form fitting with 4.5 mil thickness at the fingertips for maximum feel, -AQQGLOVE45 has been designed for comfort of professionals who need to stay in their gloves for extended periods.



- Ideal for dentists, doctors, healthcare professionals who require great sensitivity as well as protection
- Chemotherapy drug tested
- Suitable for low exposure to liquids and chemicals
- Blue color

Made of latex-free, powder-free nitrile for **strong and durable protection**

4.5 mil thickness and textured fingertips for **greater dexterity and sensitivity**

**AQUILA<sup>VI</sup>E™**  
HEALTHCARE

Ambidextrous design, beaded cuff for easy donning

Light, comfortable fit suitable for extended wear

**AQUILAVIE.COM**  
Aquila Healthcare Limited

Length (cm)	
	≥ 230
Thickness Measurement (mil)	
Finger (15mm ± 5mm from tip), Size M	≈ 0.10 (± 0.02)
Physical Properties	
Before Aging	After Aging
Tensile Strength (MPa)	≥ 14
Elongation (%)	≥ 400
Inspection Levels & AQL	
Water-tightness	0/1
Physical Dimensions	5/2
Physical Properties	5/2
Visual Inspection (Minor)	5/4
Visual Inspection (Major)	5/4
Particulate Residue	N=5

## UVC Sterilizer

- In the time it takes to read this, 99.99% of germs can be killed.
- Coronavirus in less than 3 seconds.
- Other germs in under 5 seconds.



Lab tested by SGS



### Wave goodbye to 99.99% of bacteria

Using the most advanced and powerful UVC LED technology, we bring you **DeACT**: the state-of-the-art handheld **UVC Steriliser**.

UVC effectively replaces the use of toxic disinfectants, benefiting both your health and the environment. The light will not adversely affect the disinfected surfaces, nor will it contaminate the air surrounding the cleaned surface



## Luftfilter

### CARCLEAN CC-2



#### HOCHEFFIZIENTER KOMPAKTREINIGER FÜR IHR AUTO & BÜRO

- Funktion geprüft und bestätigt durch den TÜV Süd!
- Wirksamkeit gegenüber SARS CoV 2 wissenschaftlich nachgewiesen!
- kontinuierliche Bestrahlung der Luft mit langlebiger Dual UV-C LED
- effizienter Kompakt HEPA 13 Filter, wechselbar
- sicherer und unbedenklicher Betrieb des Gerätes bei Anwesenheit von Personen (gekapseltes System)
- umweltfreundlich Kein Einsatz von Chemie, Ozon oder Ionisation
- Ultra kompakt, mobil & vielseitig
- zweistufiger Prozess HEPA Filter & UV-C Bestrahlung

### AC-400 AIRCLEAN STANDGERÄT

Standgerät zur Luftreinigung 350x640x200mm (BHT) mit integrierter UV-C Bestrahlung und HEPA 14 Filtersystem; bis zu 99,9% Luftdesinfektion. Reinigt die Umgebungsluft von Covid-19 Corona & anderen Grippe Viren mit bis zu 99,9%iger Sicherheit!

Die seit langem bekannte desinfizierende Wirkung (Oberflächen, Trinkwasser, Luft) von UV-C Strahlen setzen wir hier als Lösung des Problems der Aerosole in geschlossenen Räumen ein. In einem geschlossenen System wird die Raumluft an einer entsprechenden UV-C Strahlungsquelle vorbei geleitet.

Die Raumluft wird zusätzlich noch über Filter der Klasse G3 geführt. Da direkte UV-C Strahlung gesundheitsschädlich ist, ist die UV-Röhre in einem gekapselten System untergebracht, welches keinen Austritt nach außen zulässt.

Dies gewährleistet einen sicheren und dauerhaften Betrieb auch bei Anwesenheit von Personen. Als Einsatzgebiete sind insbesondere Klassen, Tagungs und Büroräume zu nennen.

### AC-2 AIRCLEAN GRID PANEL RASTERDECKENMODUL MIT INTEGRIERTEM UV-C LUFTREINIGUNGSSYSTEM

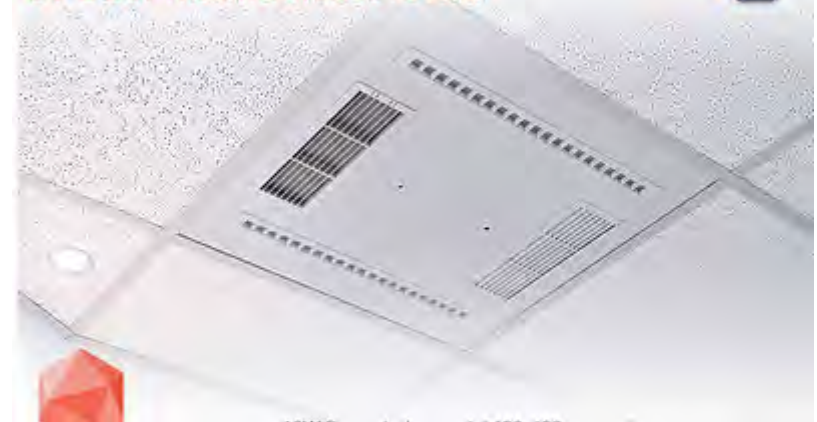

18W Rasterdeckenmodul 620x620mm mit integriertem UV-C Luftreinigungssystem; bis zu 99,9% Luftdesinfektion.

Reinigt die Umgebungsluft von Covid-19 Corona & anderen Grippe Viren mit bis zu 99,9%iger Sicherheit!

# Herrles

## Atemschutzmasken



## FFP2 & FFP3 MASKEN



**Produktinformationen / Informazioni sul prodotto**

<p><b>Produktname</b> Product name / Tipo di prodotto Model / Model / Modello Verordnung / Regulation / Regolamento: Material / Materiali Gültigkeitszeitraum Validity period / Durata della validità Anzahl / Anzahl Prüfnorm / Test standard / Standard di prova Chargennummer / Batch number / Numero di lotto Produktionsdatum Manufacturing date / Data di produzione</p>	<p><b>FFP2 Atemschutzmaske</b> FFP2 Particle filtering half mask / Facciale filtrante monouso (FF) JF802 (EU) 2016/425 <b>61,5% Spin-Vliesstoff + 38,5% Melittwoven Vlies</b> 61,5% Spunbond nonwoven fabric + 38,5% Meltblown fabric / 61,5% Tessuto non tessuto spunbond + 38,5% Tessuto meltblown <b>2 Jahre</b> 2 Years / 2 anni <b>1190</b> <b>EN 149:2001+A1:2009 FFP2 NR</b> 20211A 202011 202011</p>	<p><b>Wichtigste Eigenschaften von Bsp. 2:</b> See technical data sheet for the manufacturer's website. Leggere attentamente prima dell'uso.</p> <p><b>Temperaturbereich:</b> 0°C bis +40°C Temperature range: 0°C to +40°C Temperatura: 0°C - 40°C</p> <p><b>Maximale relative Luftfeuchtigkeit bei Lagerung:</b> Maximum relative humidity of storage conditions Condizione di conservazione: massima umidità relativa.</p> <p><b>Vor direkter Sonneneinstrahlung schützen:</b> Shelter from direct sunlight. Evitare l'esposizione diretta alla luce solare diretta.</p> <p><b>Nicht vor Wiedereinsatz:</b> Do not reuse. Non riutilizzare.</p>
--	--	--

HERRLES Technischer Rückbau & Industriemontagen (s.r.l.)  
Norsinger Strasse 12-16, 89275 Eichlingen, Germany  
info@herrles.de  
+49 7308 92910-65

Hersteller / Manufacturer / Fabricatore  
JIFA GROUP CO., LTD  
Jiangnan Development Area  
122-121 Donggang, Zhejiang  
P.R. China

**CE 2163**  
EN 149:2001+A1:2009 FFP2 NR

# Platinet

<https://www.platinet.eu/>

## DESKTOP AIR PURIFIER



- HEPA H11 filter with carbon
- 3 million/cm<sup>3</sup> or more negative ions released
- 2 adjustable speed levels
- Power: 100-240V 3.5W
- Filter change indicator
- CADR rate: 42m<sup>3</sup>/h
- Area coverage: 3-5m<sup>2</sup>
- Product size: 170 x 170 x 216 mm



## QXPure air purifiers

- The only ones that destroy viruses and bacteria



## QXPure Luftreiniger

Die Einzigen, die **Viren** und Bakterien **zerstören**

Ohne schädliches Ozon. Ohne UV-Strahlung.











**99.97%**  
Bakterien und Viren, auch SARS-CoV-2

**99%**  
Formaldehyde und andere Schadstoffe

**100%**  
Staub, Pollen und Partikel in der Luft



### QXPure Funktionen

 <b>Automatik-Modus</b>	 <b>Ag+/Cu+ Anionenfilter</b> Deaktiviert Viren und Bakterien	 <b>Aktivkohlefilter</b> Filtert Gerüche wie Zigarettenrauch und Körpergeruch
 <b>Luftqualitäts-Anzeige</b>	 <b>PM 1,0 Sensor</b> Detektiert feinste Schadstoffe in der Luft	 <b>HEPA13-Filter</b> Filtert Partikel >3µg zu 99,95% aus der Raumluft
 <b>Flüsterleiser Betrieb</b>	 <b>PM2,5 Filter</b> Detektiert und filtert Feinstaub <2,5µg	 <b>Ionisator</b> Bindet feinste Partikel wie Viren und Bakterien
 <b>Schlafmodus und Nachtdesign</b>		
 <b>Einfache Steuerung per App oder Alexa</b>		
 <b>Timer-Funktion</b>		



## Air2Color Luftqualitätsmesser mit CO2-Ampel



### GESUND UND LEISTUNGSFÄHIG DURCH OPTIMALE LUFTQUALITÄT

Faszinierendes Design kombiniert mit hochwertiger Messtechnik für exakte und zuverlässige Werte auf einen Blick.

Der AIR2COLOR PRO bewertet die 4 wichtigsten Indikatoren der Luftqualität: CO<sub>2</sub>-Gehalt, Feinstaub, Luftfeuchtigkeit und Temperatur - für Ihre Gesundheit. Das Gerät misst mit 3 hochsensiblen Sensoren präzise und kontinuierlich alle Werte und gibt Ihnen diese übersichtlich auf dem Touch-Display wieder. Der CO<sub>2</sub>-Gehalt wird zusätzlich über einen Leuchtbalken, der von allen Seiten gut sichtbar ist, in den leicht verständlichen Ampelfarben Grün, Gelb und Rot angezeigt.



#### CO<sub>2</sub>

Der Kohlendioxid (CO<sub>2</sub>)-Gehalt der Luft ist ein Indikator für verbrauchte Luft in Innenräumen. Je höher der CO<sub>2</sub>-Gehalt, desto geringer ist der Sauerstoff-Gehalt. Konzentrations- und Leistungsfähigkeit lassen nach. Außerdem weist dies auf eine hohe Aerosolkonzentration im Raum hin, welche die Ansteckungsgefahr durch Viren begünstigen kann.

Der AIR2COLOR PRO nimmt eine exakte Messung des CO<sub>2</sub>-Wertes vor. Bei Bedarf fordert er Sie mit der Ampelfunktion zum effizienten Lüften auf. Frische Luft im Raum steigert Ihre Konzentrationsfähigkeit, stärkt das Immunsystem und gibt Ihnen ein gutes Gefühl.



CO<sub>2</sub> < 1000 ppm  
Luft ist frisch



CO<sub>2</sub> > 1000 ppm  
Lüften empfohlen



CO<sub>2</sub> > 1500 ppm  
Luft ist stauend



CO<sub>2</sub> > 2000 ppm  
Lüften dringend erforderlich



Zwei verschiedene Leuchtbalken im Lieferumfang enthalten

- geeignet für Büros, Besprechungsräume, öffentliche Einrichtungen und für Ihr Zuhause (max. 80 m<sup>2</sup>)



#### FEINSTAUB

Das Thema Feinstaub und die damit häufig verbundenen gesundheitlichen Gefahren in unserem Alltag werden noch immer unterschätzt. Der hochempfindliche Sensor misst Feinstaub-Partikelgrößen von 0,4 – 10 µm, diese werden unterschiedlichen PM-Werten (1.0, 2.5, 4 und 10) zugeordnet. Dieser Messbereich umfasst die Partikelgröße von kleinsten, lungenschädlichen Partikeln bis hin zu feinem Hausstaub.

Der AIR2COLOR PRO ermöglicht so eine umfassende Bewertung der Feinstaubbelastung der Umgebungsluft. Die präzisen Messergebnisse werden Ihnen auf dem Farbdisplay angezeigt und bewertet.



#### LUFTFEUCHTIGKEIT

Eine zu niedrige Luftfeuchtigkeit verursacht häufig trockene Haut und kann sich negativ auf Ihre Schleimhäute auswirken. Viren und Bakterien bekommen so einen leichteren Zugang zum Körper. Die optimale Luftfeuchtigkeit in Innenräumen liegt bei 40-60% und erhöht laut Experten die Verträglichkeit bei Feinstaubbelastungen. Eine zu hohe Luftfeuchtigkeit kann jedoch zu Schimmelbildung führen und damit z.B. zu Allergien und Asthma.

Der AIR2COLOR PRO zeigt die aktuelle Luftfeuchtigkeit an und gibt Ihnen so eine Hilfestellung, um für optimale Werte in Ihren Räumlichkeiten zu sorgen.



#### TEMPERATUR

Experten empfehlen eine Temperatur am Arbeitsplatz von knapp unter 20° Grad, im Wohnbereich jedoch etwas wärmer.

Über das Display des AIR2COLOR PRO behalten Sie die Raumtemperatur jederzeit im Auge.

IT

# Adesso

[www.adesso.com](http://www.adesso.com)

## Wasserdichte antimikrobielle optische Maus

### Antimicrobial Medical Grade

Made with antimicrobial materials, this device prevents the growth of harmful bacteria and protects against the build up germs between washings.



Antimicrobial



### IP67 Waterproof

The Adesso iMouse W4 has a waterproof design that's rated for IP67. Its waterproof design housing protects its internal electrical parts and provides protection from powerful water jets, oil, and dust.

**IP67**  
Waterproof



### 1000 DPI Enhanced Optical Engine

The optical sensor technology keeps the device precisely on point and lets you work on most glass, wood, marble and leather surfaces without a mouse pad. 1000 DPI Resolution makes this mouse ideal for precise control and navigation.



# August

[www.augustint.com](http://www.augustint.com)

## LASERPOINTER



Mit den Modellen LP310 und LP315 können Sie während der Präsentation Markierungen auf der PowerPoint Seite zeichnen.

### August LP310 – Schnurloser Air Mouse Presenter mit integriertem Laserpointer

- Kabellose Air Maus – Steuern Sie Ihren PC einfach und präzise durch Bewegung des Presenters
- Plug&Play Dank USB 2.0 Empfänger – einfache Installation, keine Software notwendig
- Eingebauter Akku – keine Batterien notwendig, einfach per USB aufladbar
- Steuern Sie Ihre Präsentationen aus einer Reichweite von bis zu 30 Metern
- USB 2.0 Nano Empfänger kann zum sicheren Transport im Presenter verstaut werden
- Kompatibel mit Windows XP / Vista / 7 / 8 / 10, Mac OS

### August LP315 – Schnurloser Air Mouse Presenter mit integriertem Laserpointer

- Kabellose Air Maus – Steuern Sie Ihren PC einfach und präzise durch Bewegung des Presenters
- Kabelloser Presenter – Einfache Navigation durch Ihre Präsentationen
- Eingebauter Akku – einfach per USB aufladbar
- Plug&Play Dank USB 2.0 Empfänger: Ideal für Multimedia-Präsentation (insb. Powerpoint)
- LCD Display – für Ladezustand und Timer-Funktion
- USB 2.0 Nano Empfänger kann zum sicheren Transport im Presenter verstaut werden
- Unterstützte Betriebssysteme: Windows 10, 8, 7, Vista, XP, Mac OS



### August LP200 – Presenter mit integriertem Laserpointer

- Kabelloser Presenter – Einfache Navigation durch Ihre Präsentationen
- Plug&Play Dank USB 2.0 Empfänger: Ideal für Multimedia-Präsentation (insb. Powerpoint)
- USB 2.0 Nano Empfänger kann zum sicheren Transport im Presenter verstaut werden
- Unterstützte Betriebssysteme: Windows 10, 8, 7, Vista, XP, Mac OS, Linux

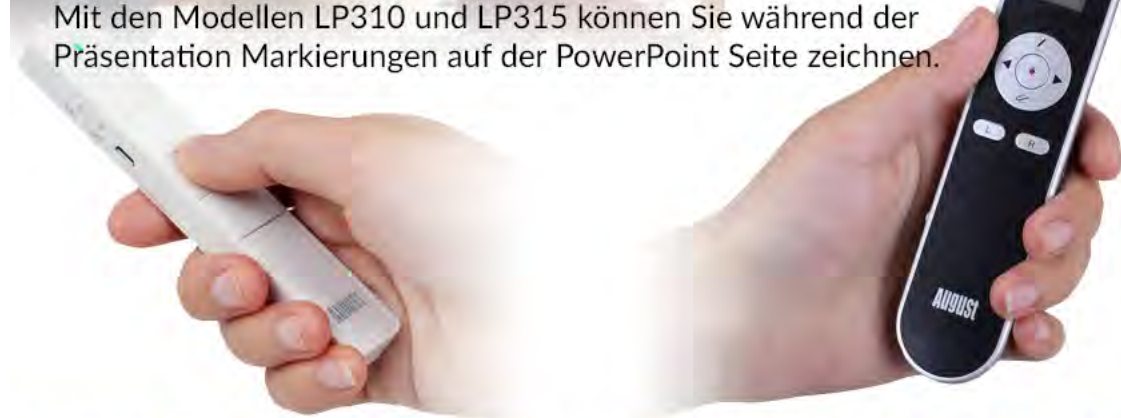

### August LP205R – Schnurloser Presenter mit integriertem Laserpointer

- Plug&Play Dank USB 2.0 Empfänger – Einfache Installation, keine Software notwendig
- Kabellose Steuerung : vor-/zurückblättern, Start/Ende, Bildschirm an/aus
- Roter Laserstrahl, Ausgangsleistung: <1mW.
- 1x AAA Alkaline Batterie sowie Kunstledertasche für den Transport im Lieferumfang enthalten.
- Unterstützte Betriebssysteme: Windows XP, Vista, 7 / 8 / 10, Mac OS, Linux

# Canyon

[digital.canyon.eu](http://digital.canyon.eu)

## Home Office Accessories



# Gyration

[www.gyration.com](http://www.gyration.com)

MICE CAN ALSO BE MOVED FREELY IN THE AIR



**AIR MOUSE™ ELITE**  
with MotionSense™



Motiontools  
Konfigurationssoftware



**AIR MOUSE GO PLUS**





## REPAPER Faber-Castell Limited Edition



**the only pencil & papergraphic tablet**



the simplicity of pencil & paper the power of a graphic tablet

**Faber-Castell Limited Edition**

### any paper

any piece of paper on the A5 digitizing surface

60+% of designers and creatives still use pencil & paper sketches for brainstorming & ideation

### any pen or pencil

any give digital super-powers to your pen or pencil with Repaper Ring on it



- 24 worldwide patents
- unique & patent protected
- technology bridging analog & digital
- the best of both worlds!

### time-lapse videos

replay and share your drawings as time-lapse videos

- all a breathtaking feature
- instantly share videos of sketches
- inspire & get inspired
- promote creativity as a lifestyle
- stand out



### the long-awaited feature

pressure sensitivity

**8192 pressure levels** (True Multi-pixel Technology®) reproduces all drawing subtleties. combined with iskn's Repaper Ring it provides a totally unique creation experience, and enjoyment.

### screenless mode

sketch wherever & whenever you want without any connected device

- all you need is a pencil & paper
- seize inspiration
- Android and iOS Bluetooth compatibilities allow sharing (email, text, social networks ...) or storage (cloud services, built-in memory)



### graphic tablet mode

compatible with all desktop drawing softwares

(True Repaper Stylus included (graphic pen) once digitized, drawings may be stored on servers/cloud or shared digitally or enriched later using any desktop software

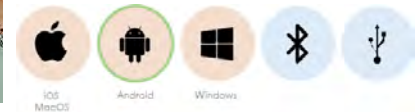

## SLATE2+ DRAWING ON TABLET LIKE ON PAPER

**the Slate 2+**

**THE PLEASURE OF PAPER. THE POWER OF DIGITAL. FINALLY UNITED.**

The Slate is destined to all creatives, illustrators, drawers and doodlers as well as pencil and paper lovers who wish to keep the natural and unparalleled feel of their pen gliding over paper while benefitting from the endless possibilities of digital technology. Your sketches are instantly reproduced on the screen of your tablet or computer using a ring around your pencil.

**the Slate 2+**

**Imageink App**

**MoMA Design Store**

iskn Slate 2+ Digital Drawing Pad

\$179

Add to Cart

Add to Wishlist

Gift wrap available

\$189 flat fee shipping available

Member and other discounts do not apply

# Lexibook

[www.lexibook.com](http://www.lexibook.com)

## INTERPRETOR NTL2000



- Works on Android 4.4
- Speaking translator with written transcription and dual mic
- Group chat function: to translate several languages at the same time!
- Offline translation for unrestricted use in 7 languages: *French, English, German, Italian, Spanish, Portuguese and Dutch!*
- Colour LCD touch screen for optimal and pleasant visibility (5cm)
- Headphones jack to listen to the translation and keep your conversations private
- Lightweight and easy to carry thanks to the wrist-strap included
- Record function
- Internal memory
- Built-in rechargeable battery (USB cable included) for an autonomous use up to 10h of continuous use, 7 to 10 days in standby mode!
- Network setting: Wi-Fi



# Penclic

[www.penclic.se](http://www.penclic.se)

## A SYMBIOSIS OF MOUSE AND PEN

mit Kabel

Kabellos



# Prestigio

[www.prestigio.com/](http://www.prestigio.com/)

## Click & Touch



### KEYS, TOUCHPAD, AND MOUSE SYMBIOSIS

It is very convenient to have a keyboard with a touchpad. However, it is much more convenient when the keyboard is the touchpad itself. More than 80% of the Click&Touch 2's working surface is a touchpad.

You can use the keyboard as a touchpad to control the cursor, click, zoom, and scroll through content. You can also use the usual left and right mouse buttons to easily select and drag the necessary objects.

## Click&Touch 2



### EASY-TO-USE TOUCH MULTIMEDIA SLIDERS

It is now much more enjoyable to watch your favourite movies by using the Click&Touch 2 keyboard. You can easily find the necessary point in the video by swiping on the left-hand side of the upper keyboard row. The right part is used to adjust the sound range comfortable for you.



### SINGLE KEYBOARD FOR ALL DEVICES

Do you need to operate multiple devices? Click&Touch 2 will cope with this task easier than you think because it can be connected to 4 devices at the same time.

There are three Bluetooth channels and a USB Type-C connector for this purpose. Click&Touch 2 is compatible with mobile devices, game consoles, computers, interactive panels, and of course, Smart TVs



# Prestigio

[www.prestigio.com/](http://www.prestigio.com/)

## Wireless charging stations

3-in-1 wireless charging station



3-in-1 wireless charging station



6-in-1 fast charging station



Wireless charging station  
for iPhone, Apple Watch, AirPods



Hidden long-distance 10W  
wireless charging station



Hidden long-distance 5W  
wireless charging station



# Sourcenext

[www.sourcenext.com](http://www.sourcenext.com)

## Pocketalk

POCKETALK



## Say hello to Pocketalk

The only two-way translation device offering authentic, accurate communication for 75 languages



- Converse in 75 languages
- Text-to-translate camera instantly recognises and translates text, the written word, and signs.
- Complimentary 2-year cellular data plan that provides coverage in over 130 countries/regions
- Sleek design with large touchscreen that provides a text translation for additional clarity
- One-button translation for simpler translations in fewer steps
- High quality noise-cancelling microphones and two powerful speakers
- Conversion: computes exchanges for currency, length, width and temperature
- Available in colors of White / Black / Gold / Red



# Swiftpoint

[www.swiftpoint.com](http://www.swiftpoint.com)

## Pro Maus

**new** Desktop Presenter – ‘lockdown or Zoom mouse’ **SWIFT POINT**

» Ideal for:-

- virtual meetings with screen sharing
- spotlight and/or laser pointer
- mark-up and annotation on screen
- save & email the 'whiteboard' photo

» Works with:-

- Zoom, Microsoft Teams, Skype, Google Meet
- Citrix GoToMeeting
- any video-conferencing screen sharing software
- any software/content open on the computer screen, Mark-up & annotate then save and email



Work from home  
Highlight | Annotate | Mark-up





# Swiftpoint

[www.swiftpoint.com](http://www.swiftpoint.com)

## Swiftpoint Mäuse

**SWIFTPPOINT**  
BE DIFFERENT | WORK DIFFERENT

Multi-award winning  
computer mice



Soooo groß ist sie nicht wirklich -  
ganz im Gegenteil



Sie ist so klein und leicht  
als hätten Sie einen Stift  
in der Hand.

Spot



Pointer



Markierung



Schrift

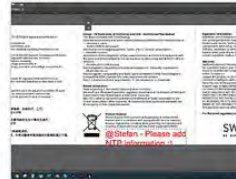

## PadPoint



- Ergonomischer Stift-Griff: CES award winning design
- Ultra-Kompakt und mobil: 5.6 x 4 x 3.3 cm
- Gewicht: 24g
- Physikalische Tasten: 2 Tasten plus ein Scrollrad
- Bluetooth 4.0
- Optischer Sensor: 1800 DPI
- RapidCharge™: Ein 60 Sekunden RapidCharge, gibt 1 Stunde Nutzung
- Lange Akkulaufzeit: Bis zu 2 Wochen mit einer vollen Ladung über das USB-Ladegerät
- Funktioniert auf fast jedem Gerät: iPad/iPhone, Mac, Windows und Android



## LEFTHANDED MOUSE

**Der 13. August ist  
LINKSHÄNDERTAG**



### Internationaler Linkshändertag

Dean R. Campbell, der 1975 auch Lefthanders international gründete, rief den 13. August zum internationalen Linkshändertag aus, der seit dem Jahr 1976 gefeiert wird. Die 13 im Datum wurde als Zeichen gegen Aberglauben gewählt, weil Linkshändigkeit oft mit entsprechenden Vorstellungen verbunden war. In den letzten Jahren hat der Linkshändertag zunehmend Berichte über Linkshändigkeit am 13. August in verschiedenen Medien angeregt



#### MWLEFT kabellose Linkshänder-Maus

- für optimale Handhaltung bei Linkshändern
- 5-Tasten Maus
- Silent Click
- On/Off Schalter und Auto Stand-By System
- Stromversorgung: 2 x AAA (inklusive)
- kompatibel mit Mac und PC
- DPI: 800 / 1200 / 1600
- 2,4 GHz
- Anschluss: kabellos (USB Empfänger)



#### MLEFT Linkshänder-Maus mit Kabel

- für optimale Handhaltung bei Linkshändern
- 5-Tasten Maus
- Silent Click
- kompatibel mit Mac und PC
- DPI: 800 / 1200 / 1600
- Anschluss: USB

# Timekettle

[www.timekettle.co](http://www.timekettle.co)

## WT2 Plus

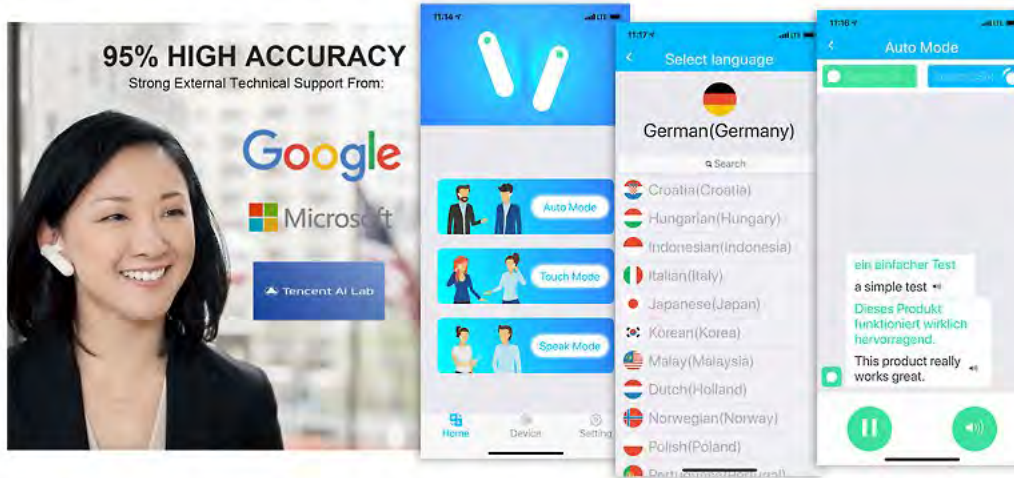

Sensationell gute Sprach-Übersetzungen für Geschäftsreisende und Touristen: 2 Earplugs + 1 Smartphone reichen!

Derzeit in 36 Sprachen. Basierend auf künstlicher Intelligenz.

Beispiel:

Sie sprechen Deutsch, der Spanier hört Spanisch.

Der Spanier antwortet, Sie hören Deutsch.

Und alles auch zum Mitlesen auf dem Smartphone.



36 Sprachen / 88 Akzente



**AUTO MODE** INTENSIVE ERFAHRUNG  
Entwickelt für ruhige Umgebungen

**TOUCH MODE**  
VOLLE KONTROLLE MIT EINEM TAP  
Entwickelt für komplexe Umgebungen

**SPEAKER MODE** ENTDECKE MÖGLICHKEITEN  
Entwickelt für kurze und einfache Gespräche



**Intelligenter Algorithmus - ON-THE-GO**

**Lange Akkulaufzeit - mehr als Du brauchst**

**OTA Technologie - (Over-The-Air)**

# Timekettle

[www.timekettle.com](http://www.timekettle.com)

## WT2 Plus

**World's first AI-powered translation system!**

1 App controls 2 earphones.

By integrating industry-leading voice algorithm and machine translation technology, WT2 Plus delivers hands-free and natural communication, regardless of language barriers.

WT2 Plus defines AI translators in an innovative way that will bring new opportunities at both users and businesses.



**36 LANGUAGES + 88 ACCENTS**

Conversing 85% of the entire population in the world



**MULTI-CHANNEL COMMUNICATION TECHNOLOGY**

**Patented by Timekettle Technologies**

WT2 Plus utilizes a unique signal processing technology that is significant advance over other competitors on the market. No need to pass the phone, or ask others to download a new app. All you need to do is wear an earphone. WT2 Plus is the only one of its kind!



**Dual Noise Reducers - every word counts!**

Adaptive Beamforming Algorithm and Adaptive Noise Cancellation based on Neural Network empower up to 95% translation accuracy. Tested and verified in actual environments.



**95% HIGH ACCURACY**  
Using Customized Translation Support Files

**LONG STANDBY & BLUETOOTH CONNECTION**  
Public, Traffic, Power Save, Wireless Connection for Android & iOS

300+ Languages, 15+ Accents, 30+ Dialects



**Intelligent Algorithm ON-THE-GO**

Industry-leading AI algorithm enables communication even in the most complex and challenging environment. With Auto Voice Detection and Auto Pick Up, WT2 Plus delivers absolute hands-free.

**THREE MODES**  
 2 - Way Translation — Breaking Language Barriers

**AUTO MODE IMMERSIVE EXPERIENCE**

Designed for quiet environments  
 Each wears an earphone translator in a 2 people conversion. Any spoken sentences will be automatically recognized, and translated to a different language that the other person understands. Completely hands-free and natural, so immersive that WT2 Plus disappears into the experience.



**TOUCH MODE FULL CONTROL IN A TAP**

Designed for complex environments  
 The earphone translator will only activate by touching the earphone's sensor area with your finger. Hold your finger on the sensor while speaking. Let go of your finger after you've finished, the translation will start immediately, and play to both earphones.



**SPEAKER MODE EXPLORING POSSIBILITIES**

Designed for quick and easy conversations  
 Connect and wear one earphone translator yourself. When you speak, translation results will be played through the speaker on your mobile phone. If the other person wants to respond to you, just answer through the speaker on your phone. This mode enables conversations for more than 2 people.



HOME OFFICE

# Adesso

[www.adesso.com](http://www.adesso.com)

WebCams +



**ADESSO™ Work from Home ESSENTIALS**

Protect yourself and others from virus spread with our waterproof, washable, antimicrobial input devices.

**ANTIMICROBIAL** (ANTIMICROBIENNE / ANTIMICROBIAL)  
**WATERPROOF** (ÉTANCHE / WASSERDICHT)  
**WASHABLE** (LAVABLE / WASCHBAR)



CyberTrack H2 – 480P HD USB Webcam with Built-in Microphone



CyberTrack H3 – 720P HD USB Webcam with Built-in Microphone



CyberTrack H4 – 1080P HD USB Webcam with Built-in Microphone



**Xtream G1**  
Stereo Gaming Headphone/Headset with Microphone



**Xtream H4**  
Stereo Headphone/Headset with Microphone



**Xtream H5**  
Multimedia Headphone/Headset with Microphone

# Blizzard

[www.blizzard-webcam.com](http://www.blizzard-webcam.com)

## WebCams



Blizzard A335-S Pro Webcam



2 Analogue  
Mikrofone



Blizzard A355-S Pro Webcam



## ULTRA-SCHARF UND SCHNELL



Blizzard A330 Pro Webcam



Blizzard A350 Pro Webcam



Blizzard A380 Pro Webcam



Blizzard JH-15 Webcam  
HD 1080p (1920x1080) - 30 Bilder / Sek.

# Blizzard

[www.blizzard-webcam.com](http://www.blizzard-webcam.com)

## PLATZHALTER – H4



THE WORLD HAS NO DISTANCE

### Blizzard H4 Headset

#### Noise canceling microphone

Right sided, omnidirectional microphone with noise cancelling for better voice capture and background noise reduction.

#### Plug-and-play USB-A connectivity

Easily connects to PCs with no additional software required. Headset is shipped with fixed USB Type-A cable.

#### USB type A connection

USB type A connection to support DT and NB PC's



Blizzard H4 Headset + USB-A to USB-C Adapter



# Platinet

[www.platinet.eu](http://www.platinet.eu)

## LCD WRITING TABLET



## LCD WRITING TABLET

**Saving Paper up to  
100,000 pages**



### **PLATINET DRAWING TABLET**

The Platinet tablet is the perfect solution for children who like to draw, as well as all those who can not imagine life without handwritten notes. It protects the environment, eliminating the need to use traditional paper.

### **SKETCH, DRAW NOTE**

The tablet has a specially adapted screen with low energy consumption, which, in combination with the included stylus, allows you to take handwritten notes and drawings just as comfortably as on paper - written text appears on the screen immediately, and pressure is also distinguished. The button under the screen allows you to delete the entire screen content with just one click.

### **COMFORTABLE SOLUTION**

The device weighs only 150 grams and is ultra-thin, so you can easily take them with you wherever you want. The replaceable CR2016 battery allows you to sketch approximately 100,000 pages. The stylus included in the set is as easy to use as a traditional pen. It can be hidden in the tablet casing, which prevents it from being lost.

### **TECHNICAL SPECIFICATIONS:**

Display: 8.5"/21,5cm flexible LCD panel

Housing: ABS plastic

Power supply: CR2016 battery

Dimensions: 149.7 x 220.5 x 7 mm; Weight: 150 g



# Sandberg

<https://www.sandberg.world>

## Headsets



Headset 126-08



# Sandberg

[sandberg.world](http://sandberg.world)

## WebCams



# Sandberg

## Pro Conferencing Kits

### Wireless Speakerphone Pro



### ConfCam PTZ x10 Remote



## ConfCam PTZ Pro - 134-31



EDUCATION

# Boogie Board

[www.myboogieboard.com](http://www.myboogieboard.com)

## ELECTRONIC BOARD

boogie board®

jot<sub>4.5</sub>

A small writing surface to quickly jot notes, phone numbers or lists. Easily take it to go or place it in convenient locations around the home or office.



jot<sub>8.5</sub>  
eWriter

The new, super high contrast writing surface creates an almost luminescent line for writing notes, lists and reminders. The free app allows you to save, edit and share what you've created.



edit

shop

share

scan

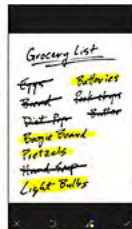
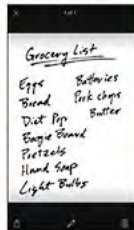

Blackboard™  
boogie board

A writing tool to plan, sketch and design just like paper.

Blackboard™  
boogie board

Screen size: 13.75" (diagonal)  
Weight: 0.8 lb. (27mm)  
Dimensions: 9.125" x 0.25" x 12.875" (232mm x 6.4mm x 327mm)  
Includes: Blackboard, Blackboard Pen, 4 Templates

### Back to basics

Somehow it's electronic. Somehow you'll never notice. Write, edit, and erase just like pencil on paper.

### Write on anything

Insert the templates for lines, grids, and more. Or write on documents, photographs, or even digital screens.

### Save & share

The free Blackboard app makes it easy to save, organize, search, and share your work doodles, designs, and more.



LiquidCrystalPaper.com

# Boogie Board

[www.myboogieboard.com](http://www.myboogieboard.com)

## ELECTRONIC BOARD FOR KIDS

jot 4.5 featuring CLEAR VIEW™ eWriter



case pack consists of 6 units

- Allows kids to trace the included alphabet flashcards or practice math flashcards on the Free App
- Drives kids to use their imagination
- Trace anything at home or on the go



The first-of-its-kind translucent LCD allows children ages 3-10 to write, trace and draw. The large surface area helps kids develop fine motor skills, build memory and create!



case pack consists of 10 units



Free app developed by Excellent Play, global leader in scientific research about play, learning and child development.



Scribble n' Play™



case pack consists of 6 units

- First ever color eWriter
- Interactive activity inspires creativity
- Compact, fun, durable design
- Save, Edit & Share content with App

featuring colorburst



# CorrectBook

[www.correctbook.com](http://www.correctbook.com)

## Correctbook

WRITE ENDLESSLY IN THE PREMIUM REUSABLE NOTEBOOKS OF CORRECTBOOK

**CORRECTBOOK.**  
endless writing for everyone

THE CORRECTBOOK PDF SCAN APP

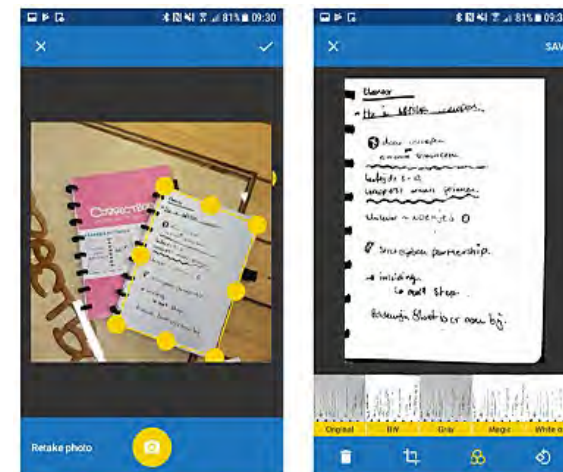

### HOW DOES THE CORRECTBOOK® WORK?

The writing on the Correctbook® cannot be erased with the hand. We have the following products available to erase your notes:

- the back of the marker
- a dry or wet cloth
- the Correctbook® cleaning set





# Czur

## SMART BOOK SCANNER



ET16 Plus Smart Book Scanner

Revolutionary Book Scanning Solution



- Scan Bound Books
- Two Pages in 1.5s
- Flattening Curve
- Edit Text with OCR
- Side Lighting
- Visual Presenter



Law / CPA Firm



HR / Administration



University / School



Accounting / Finance



# Neo Lab

[www.neosmartpen.com](http://www.neosmartpen.com)

## NEO SMARTPEN M1



### A Smaller But Smarter Pen

How can we make a smart pen which is very similar to an ordinary pen? With this question as a goal in everyone's mind at NeoLAB Convergence, Neo smartpen M1 was designed and created. Now, Neo smartpen M1 shall be the answer.



### A Smooth But Sturdy Pen Body

Neo smartpen M1 has employed fiber glass material for sturdy body to protect external shock.

### The Thinnest And Lightest Smart Pen

Neo smartpen M1 has employed a thinner and lighter pen body. Cylinder shape body case helps your smooth writing with comfortable grip.



### Simple And Casual Design

The compact and simple design of Neo smartpen M1 allows a more uninterrupted writing experience than ever. Vibrant color variations reflect young and trendy product personality.



# Neo Lab

## SMARTPEN WITH DESIGN AWARD

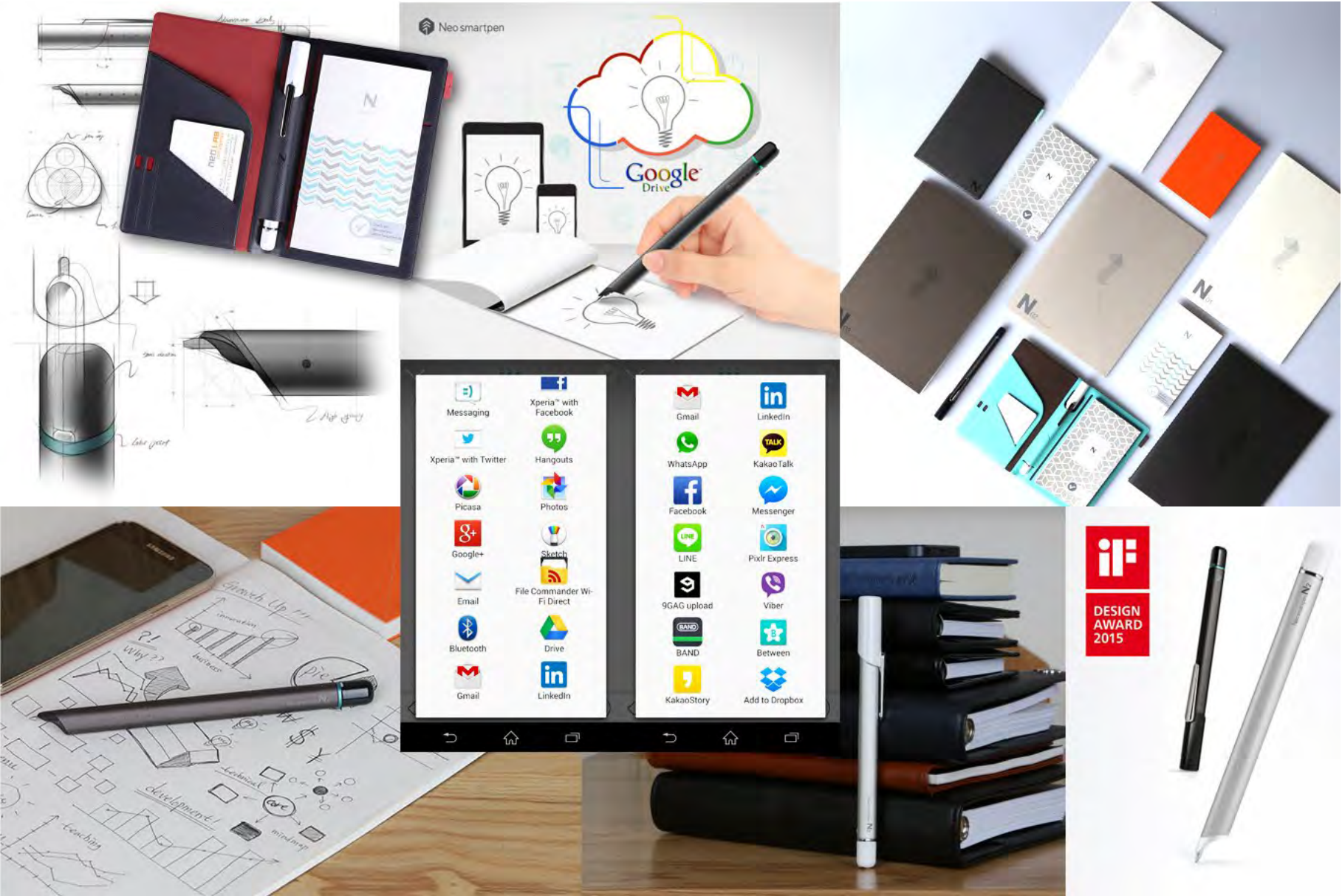

# Neo Lab

[www.neosmartpen.com](http://www.neosmartpen.com)

## SMARTPEN & MOLESKINE

**MOLESKINE**  for Neo smartpen



**classic**  
COLLECTION

hard cover  
couverture rigide



### Ncode™ Technologie

Ncode™ ist eine Kombination von Linien und Symbolen die so winzig gedruckt sind, dass man sie mit dem blossen Auge kaum sehen kann. Jede Zeilen/Symbol Kombination erzeugt einen eindeutigen Code für jede Stelle auf der Seite.



Neo smartpen



# Neo Lab

[www.neosmartpen.com](http://www.neosmartpen.com)

## SMART CLASS KIT

A whole new way of making an explanation video

Without Smart Class Kit



- a lot of equipment
- costs a lot of time in preparation
- costs a lot of time in post-processing
- simply costs a lot of money

With Smart Class Kit



- little equipment
- quick start
- low costs



PlatePaper (Plate)

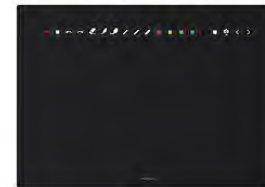

Device Stand

Stylus tip

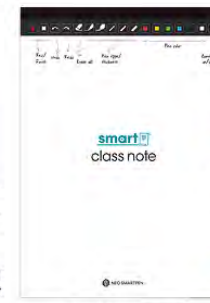

Smart Class Note

Paper controller



User Manual



GRAB & WRITE



**EASY**  
Easy to use

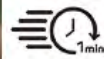

**SHORT**  
Short preparation time



**LIGHT**  
Light & Portable



**SAVE**  
Save in MP4 & PDF



**SIMPLE**  
The most familiar tool,  
Pen & Paper



**QUICK**  
Make a video in under 5 minutes  
(No rendering needed)



**FREE APP**  
No subscription fee



**RECORD YOURSELF**  
Show your expression

	Smart Class Pen
Bluetooth	4.2 (BLE)
Recognizable Angle	-30° ~+40°
Size	140 x 14.7mm (include pen cap: 145mm)
Weight	26.5g (include battery) (include pen cap: 33g)
Color	Black
App	PaperTube
OS	iOS, AOS
Battery	Alkaline AAA 1.5V (1ea)
Pen Tip Type	D1 type



# Neo Lab

## PaperTube

**PaperTube** - your own portable video recording studio with various background templates.

### Functions



#### Modify Pen Type

Modify type, color and thickness of pen while recording



#### Camera Control

Switch between front & rear camera and change position of the screen



#### Automatic Saving

Automatically save the video in album or download folder after video recording is finished



#### PDF Format

Share handwritten data while recording in PDF format with the background

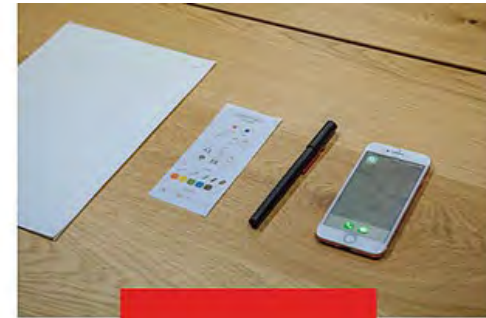

With Ncode A4 product package and a Neo smartpen, you can start using PaperTube.  
Ncode A4 product package is composed of Ncoded paper for a blueprint, smartphone stand, and PaperTube controllers.



Ncode A4



PaperTube Controller



Paper Cradle



## SHOWCASE YOUR STORY



Powered by Neo smartpen

SHOWCASE

YOUR IMAGINATION • YOUR CREATIVE • YOUR LIFE  
YOUR LECTURE • YOUR MOMENTS • YOUR MEMORIES

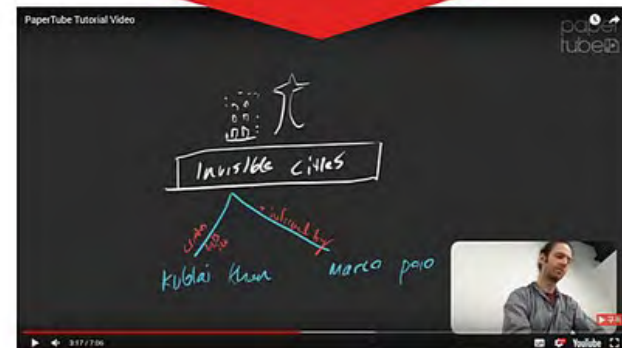

# Promate

## Influencer Produkte

<p><b>Smart enough for your smartphone</b> Quick way to mount or unmount and align your smartphone</p> <p>USB Powered</p>	<p><b>Unsurpassed Performance</b> Achieve high definition audio recording quality</p>	<p><b>Step Up Your Creative Game</b> 3 lighting modes along with 10 brightness levels. VlogPro will meet your lighting needs in any environment.</p> <p>3 Lighting Modes</p>
	<p><b>PROMATE</b> PROFESSIONAL ALL-IN-ONE VIDEO CREATION KIT <b>ON AIR</b></p>	<p><b>Compatibility</b> SLR, DSLR Cameras and Action Cams</p> <p>Ball Head Mount Included</p> <p><b>Versatile Stand Positions</b></p>

**Remote Controlled Rotatable Head**

**Bluetooth Remote Control**  
Wireless controller for easy shutter and rotation controls

**2-Way Pan and Tilt**  
Fluid Smartphone Positioning



## Influencer Produkte

EVERYTHING  
INFLUENCERS  
NEED



GAMING

# Whiteshark

## Gaming



# eShark

[www.smit-electronic.hr](http://www.smit-electronic.hr)

## Gaming



# Platinet

[www.platinet.eu](http://www.platinet.eu)

## Gaming



### PRO-GAMING STEREO BACKLIGHT HEADSET

HQ GAMING EXPERIENCE  
COMFORTABLE HEADBAND  
NOISE CANCELING MICROPHONE  
HI-FI SOUND SYSTEM

RGB Effect Backlight

Connected Solutions:  
1. 2x Mini Jack 3.5mm  
2. USB Plug

## VH8020



Compatible with:  
Android devices, iPhone & iPad, Windows devices

**Never Stop Gaming!**  
We'll redefine all you know about sound effect! Thanks to advanced solutions experience from gaming you will reach a whole new level! Headphones designed for long play sessions will let you draw all the best gaming world has to offer.

### PRO-GAMING STEREO BACKLIGHT HEADSET

HQ GAMING EXPERIENCE  
COMFORTABLE HEADBAND  
NOISE CANCELING MICROPHONE  
HI-FI SOUND SYSTEM

RGB Effect Backlight

## VH8010



Compatible with:  
Android devices, iPhone & iPad, Windows devices

### ERGONOMIC PRO-GAMING MOUSE

RESOLUTION UP TO 2600DPI  
9 COLORS OF LED BACKLIGHT  
HIGHEST PERFORMANCE

LEO Backlight

The mouse remarkably can be a charge of using. It features 6 buttons on the mouse, 4 buttons on the left side, more comfortable and personalized operation.

EXAR Optical Gaming Mouse PL Mouse experience the greatest

- 4 buttons
- 4 DPI levels
- 6000 DPI up to 4 clicks
- 2600 DPI
- 3000 DPI
- Ergonomic design

- PL Mouse experience the greatest
- 4 buttons
- 4 DPI levels
- 2600 DPI up to 4 clicks
- 3000 DPI
- Ergonomic design

## VGMLB



UP TO 2600 DPI

CHANGEABLE Colour Backlight

# Sandberg

## Gaming

**EsportsEquipment**

- 7 LED lighting earphone
- 21 Visual Surround Sound
- Double Quality Tested
- USB Connector
- 5 Years Warranty
- Gaming optimized
- Volume control on ear-cup

A large black Sandberg headset with a microphone and a USB connector is shown against a background of a gaming arena.

**Sandberg EsportsEquipment** 5 Years Warranty **USB Massage Pillow**

Splashgames.de:  
»Wer es dennoch noch etwas gemütlicher haben möchte, dem empfehle ich noch den Kauf des Massagekissens. Eine Wohltat für jeden geschundenen Gamerrücken.«

WhatNext:  
»Sandberg USB Massage Pillow can relax during the day or longer work. Laying on it without vibration is also convenient. If you have a chair without a pillow, and you sit in front of the computer for a long time and want to try a massage, then you can invest in it.«

A black USB Massage Pillow is shown in a gaming chair and in a separate view. The background features a gaming event with people and lights.





IT-ACCESSORIES





# CTA Digital

## WALL AND DESK MOUNTS

**PAD-SKMSB**  
2-in-1 Security Multi-Flex  
Tablet Stand and Wall Mount



· K-slot security headpiece lock and slot on stand legs  
· Flexible hinges enable angle adjustment in any mount mode  
· Locking anti-theft tablet holder Compatible with 7-14" tablets



**PAD-KHC9**  
Kickstand Handgrip Case  
with Security Enclosure Jacket



· Ultra durable metal case for protection  
· 360-degree rotating comfort handgrip with built in kickstand provide quick ease of switching between any mount mode  
· Sturdy key lock for tablet security  
· Compatible with iPad Pro 9.7"



**PAD-TGSK**  
Tri-Grip Tablet Security Clasp with  
Quick-Connect Base and VESA Mount



· Resizable tri-grip security clasp for sturdy hold and protection from theft  
· Quick-connect mechanism for fast switching from any mount types  
· 360-degree rotation angle adjustment  
· Compatible with 7-13" tablets



# CTA Digital

[www.ctadigital.com](http://www.ctadigital.com)

## SECURITY CASES FOR TABLETS



**LOCKPOINT**  
BY CTA DIGITAL



2 Sides, 2 Tablets

Locking Case & Cable

Stylus & Tether

Constructed from heavy-gauge steel, CTA Digital's Lockpoint series of tablet kiosk stations represents the pinnacle of security, style and functionality and embody our commitment to quality and innovation. Please check out the product demo videos linked below and get in touch if you would like more information. We look forward to hearing from you!

### PAD-LOC



#### UNIVERSAL TABLET KIOSK STATION

- Premium steel locking, slide-adjust holder
- Full access to charge port, jacks, and buttons
- Tilts and rotates with ease
- Stylus and tether

Compatible with tablets 5.125 to 8 inches in length and 8 to 12 inches in height, including Galaxy Tab S 10.5, Galaxy Tab Pro 10.1, iPad 9.7, iPad Air, iPad Pro 9.7, iPad mini, and more

[▶ PLAY VIDEO](#)

### PAD-LOC



#### TABLET KIOSK STATION

- Premium steel locking enclosure
- Full access to charge port, jacks, and buttons
- Tilts and rotates with ease
- Stylus and tether

Compatible with iPad Air, iPad Pro 9.7, iPad Pro 10.5, iPad 9.7, Galaxy Tab S3 9.7, and Galaxy Tab S2 9.7

[▶ PLAY VIDEO](#)

### PAD-LOC2



#### DUAL TABLET KIOSK STATION

- Premium steel double tablet security enclosures
- Inventive table tent design
- Full access to charge ports, jacks, and buttons
- Styluses and tethers

Compatible with iPad Air, iPad Pro 9.7, iPad Pro 10.5, iPad 9.7, Galaxy Tab S3 9.7, and Galaxy Tab S2 9.7

[▶ PLAY VIDEO](#)



# Cyber Clean

[www.cyberclean.net](http://www.cyberclean.net)

## HOME & OFFICE CLEANING



**Deep cleaning action**  
based on the 3 in 1 formulation  
**Tiefenreinigung**  
durch die 3 in 1 Formulierung



**PROVEN TO KILL 99.999% OF GERMS\***  
**ELIMINIERT KEIME ZU 99.999%\***



PATENTED FORMULA  
ELIMINATES UP TO 99.999% OF GERMS\*

# Cyber Clean

THE HIGH-TECH CLEANING COMPOUND

CATCHES DIRT AND ELIMINATES GERMS!

**Cyber Clean**  
THE HIGH-TECH CLEANING COMPOUND  
SCHUTZ ABSORBIERENDE HIGH-TECH REINIGUNGSMASSE  
HOME & OFFICE

**Cyber Clean**  
THE HIGH-TECH CLEANING COMPOUND  
SCHUTZ ABSORBIERENDE HIGH-TECH REINIGUNGSMASSE  
HOME & OFFICE  
ELIMINATES UP TO 99.999% OF GERMS\*

# Fixed

[www.fixed.zone/](http://www.fixed.zone/)

## Graphite Active Stylus for Apple iPad



- Stylus accuracy per pixel and zero delay
- Supports palm rejection for natural hand placement while using Graphite
- Smart tip which dynamically adjusts line weight depending on the angle you place it down
- The stylus includes magnets to attach to the body of the iPad
- Aluminum body
- Battery life up to 20 hours
- Use the pen while it is charging
- USB-C charging
- Auto-off when not in use
- Compatible with all iPads from 2018 to today



# Fixed

## Styluses for Tablets

### PEN ANTIBACTERIAL

#### Pen 3in1 stylus and stand

FIXED Pen is a practical help for every smartphone or tablet owner. It hides three useful features to make your everyday life easier.

As a stylus, it's designed to conveniently handle all of the capacitive displays and dramatically improve work and writing on your smartphones or tablet. The rubber tip is gentle on the display, and you will not have to deal with constant smudges and fingerprints.

Simply turn the stylus into a classic pen that you will always have at your fingertips.

The FIXED Pen can also serve as a stable base for your device, thus fulfilling the function of a practical stand. You can conveniently watch movies, browse the web, or make a video call.

FIXED Pen is available in three versions – aluminium, plastic and bamboo. All three types have an antibacterial surface.

Product code:  
FIXPEN



### PEN

#### Pen 3in1 stylus and stand

FIXED Pen is a practical help for every smartphone or tablet owner. It hides three useful features to make your everyday life easier.

As a stylus, it's designed to conveniently handle all of the capacitive displays and dramatically improve work and writing on your smartphones or tablet. The rubber tip is gentle on the display, and you will not have to deal with constant smudges and fingerprints.

Simply turn the stylus into a classic pen that you will always have at your fingertips.

The FIXED Pen can also serve as a stable base for your device, thus fulfilling the function of a practical stand. You can conveniently watch movies, browse the web, or make a video call.

Product code:  
FIXS-PEN



FIXE

### PIN

#### Active stylus for touch screens

Practical tool for every smart phone or tablet owner.

It refines and simplifies touch screen operation and makes all touch screen activities easier – drawing, writing, editing photos and more.

The hardened polyacetal tip reduces friction when you touch the screen, giving you the same feel as with classic writing on paper.

The stylus is activated by pressing the clip at the top and it is immediately ready for use with your tablet or mobile phone.

Built-in battery lasts up to 5 hours of continuous operation, when discharged, you can recharge the battery with the micro USB cable supplied.

Product code:  
FIXS-PIN



## MULTI-PORT USB / USB-C CHARGING STATION

**LVSUN CS52Q1 - 5-Port USB Schnellladestation (5x 2,4A) / 60W /**



5-Port USB Schnellladestation mit je 2,4 A Leistung und 60W Power  
Optimaler Ladestrom für jedes Gerät.  
Eingangslleistung: AC100-240V 1,5A (insgesamt 8A) 50 / 60Hz  
Ausgangsleistung: DC 5V / 2,4A x 5 (gesamt 60W)  
Maße: 158 x 129 x 90mm

**LVSUN LS-10U24F-AE - 10-Port USB Ladegerät (10 x 2,4A) /120W**



10-Port USB Schnellladestation mit je 2,4 A Leistung und 120W Power  
Intelligenter Chipsatz für optimalen Ladestrom  
Eingangslleistung: AC100-240V 1,68A (insgesamt 8A) 50 / 60Hz  
Ausgangsleistung: DC 5V / 2,4A x 10 (gesamt 120W)  
Maße: 156 x 109 x 33mm

**LVSUN LS-4U / 4-Port USB Reise Ladegerät (2 x 2,4A und 2 x 1A) /34W**



4-Port USB Reise Ladegerät (2 x 2,4A und 2 x 1A) und 34W Power  
Intelligenter Chipsatz für optimalen Ladestrom  
Überspannungsschutz, Kurzschlusschutz, Überhitzungsschutz.  
Weltweit kompatibel, austauschbare Stecker.  
Ausgang: DC 5V / 2,4A x 2 und DC 5V / 1A x 2  
Maße (L x B x H): 96 x 50 x 41mm

**LVSUN LS-5US / 5-Port USB KFZ-Schnellladegerät / 36W**



-5-Port USB KFZ-Ladegerät (3 x 2,4A oder 5 x 1A möglich) / 36W in schwarz  
Maximale Ladeleistung gesamt: 7,2A  
Eingangslleistung: DC 12-24V / 3,8A  
Ausgangsleistung: DC 5V 2,4A x 3 oder DC 5V 1,2A x 4 und 2,4A x 1  
Maße (L x B x H): 102 x 34 x 16mm

**LVSUN LS-QW45-PD / USB-C Ladegerät / 45W**



Praktisch für die Reise mit austauschbaren AC-Steckern für verschiedene Länder  
USB-C- und USB-Typ-A-Geräte gleichzeitig  
Eingangslleistung: AC 100-240V 50 / 60Hz 1,2A  
USB-C Ausgangslleistung: DC 5-20V 3A (MAX)  
USB-A Ausgangslleistung: DC5V3A (MAX)  
Leistung: 45W (MAX)  
Größe: 69 x 67 x 32mm

**LVSUN LS-PD60 / USB-C Laptop Netzteil / 60W**



USB-C- und USB-A-Anschluss  
Überspannungsschutz, Kurzschlusschutz und Überhitzungsschutz.  
Eingang: AC 100-240 V 1,5 A 50/60 Hz  
Ausgang USB-C-Anschluss DC 5 V / 9 V / 15 V / 20 V / 3A (max.)  
Ausgang USB-A-Anschluss DC 5 V 2A (max.)  
Leistung: 60W max.  
Abmessungen: 114 x 70 x 17mm

**LVSUN LS-Q3U-PD / USB-C Laptop QC3.0 Netzteil /40W**



USB PD2.0 und Qualcomm® Quick Charge™ 3.0 Technologie  
Überspannungsschutz, Kurzschlusschutz und Überhitzungsschutz.  
Eingangslleistung: AC 100-240V 50 / 60Hz 1A  
Out 1: DC 5-20 V 3A (max.)  
Out 2: DC 3,6-6,5 V 3A, 9 V 2A, 12 V 1,5 A, 20 V 1A  
Leistung: 40W (max.); Größe: 109 x 65 x 16 mm

**LVSUN LS-Q4U / 4-Port USB 2.0 Schnellladegerät / 58W**



4-Port USB 2.0 Schnellladegerät / 58W  
Eingangslleistung: Wechselstrom 100-240V 1,5A 50 / 60Hz DC 12-24V 5,5A (max.)  
Ausgangsleistung: DC 5V 3,0A x 1 und DC 5V 2,4 x 3 & 9V 1,67A x 4 und 12V 1,2A x 4  
Maße: 125 x 78 x 28mm

**LVSUN LS-Q5U-PD / USB-C Laptop Netzteil / 80W**



Stromversorgung für Laptops, Smartphones und Tablet-PCs.  
Qualcomm® Quick Charge™ 3.0-Technologie  
Eingangslleistung: AC 100-240V 50 / 60Hz 1,8A  
Ausgangsleistung 1: DC 5-20 V 3,5 A (max.)  
Ausgangsleistung 2: DC 3,6-6,5 V 3A, 9 V 2A, 12 V 1,5 A, 20 V 1A  
Leistung: 80W (max.)  
Größe: 110 x 98 x 20 mm

**LVSUN LS-Q5U-PD-1 / USB-C Laptop Netzteil / 80W**



Qualcomm® Quick Charge™ 3.0-Technologie  
Überspannungsschutz, Kurzschlusschutz und Überhitzungsschutz.  
Eingangslleistung: AC 100-240V 50 / 60Hz 1,8A  
Ausgang 1: DC 5-20 V 3,5 A (max.)  
Ausgang 2: DC 3,6-6,5 V 3A, 9 V 2A, 12 V 1,5 A, 20 V 1A  
Leistung: 80W (max.); Größe: 110 x 98 x 20 mm

# LVSUN

[www.enlvsun.com](http://www.enlvsun.com)

## USB-C Laptop AC Adapter



## Ultra Slim Universal Laptop AC/DC Adapter





# LVSUN

[www.enlvsun.com](http://www.enlvsun.com)

## SUPER FAST DUAL CHARGER for Camera/camcorder battery

Charging Speed is 3 times faster than normal charger

Can charge 2 same or different batteries simultaneously at home or in car



Home Use



Car Use



Auto-detecting  
Charging voltage



Interchangeable battery plates for all  
the brands of camera/camcorder



100% Compatible with Original Equipment  
Quick Charge Capability  
No Memory Effect

# Platinet

## Overview



# Rain Design

## Laptop- & Tablet-Stands



# Sandberg

## Survivor Cables

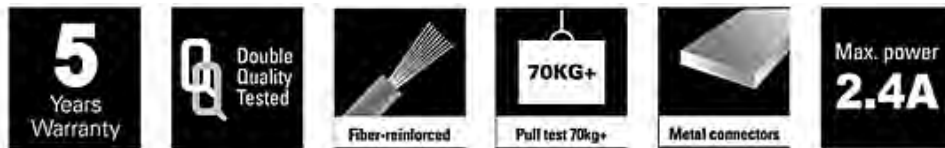

**Das Sandberg Survivor Cable ist ein Ladekabel, das für die Ewigkeit gefertigt wurde!**

Das Kabel besteht aus extrem starken Kevlar mit doppelt geflochtenem Nylon ummantelt. Wobei die Stecker aus Gussmetall gefertigt wurden.

Die extra starken Stecker und stabil mit dem eigentlichen Kabel verbunden sorgen dafür, dass die Steckkontakte nicht vom Kabel abbrechen.

Alles wurde mit über 70 kg Zugkraft und mehr als 60.000 Biegungen getestet.

## PC Zubehör

## Information

Sehen sie alle Produktlinien der Sandberg Produkte unter [www.sandberg.it](http://www.sandberg.it)

### SPEICHER

**133-76 USB 3.0 Hard Disk Dublizierungskabel**

- Verbesserung der Notebook Festplatte
- Schnell und Anwendungsfreundliches Festplatten duplizieren

**133-87 USB 3.0 to SATA Link**

- Sofortige Festplatten Verbindung
- Datengeschwindigkeit bis zu 5 Gbit/sec

**USB 3.0 Multi Harddisk Link**

- Sofortige Festplatten Verbindung
- Datenrate bis zu 5 Gbit/sec

**133-79: Europäische Leistung**

**133-80: Englische Leistung**

**133-66 USB Mini DVD Brenner**

- Brennen und lesen von CDs and DVDs
- Bis zu 24facher Schreibgeschwindigkeit
- USB betrieben
- Unterstützt CD-R, CD-RW, DVD-R & DVD-RW

**133-73 USB 3.0 Multi Card Leser**

- Augenblicklicher Zugriff auf praktisch jeden Typen von Speicherkarten ohne Adapter
- USB 3.0 Verbindung für schnellste Übertragungsgeschwindigkeit
- Bis zu 5GB/sec

**133-74 USB 3.0 Festplattenduplizierer**

- 2 Festplatten auf ein USB Anschluss
- Sofortiges Festplatten duplizieren

**LEISTUNGSZUBEHÖR**

**135-66 Laptop AC Adapter Mini 90W**

- Super schlankes Design
- Für die meisten Notebooks auf dem Markt
- USB Port zum Laden von portablen Geräten

Viele weitere Artikel finden Sie auf [www.sandberg.it](http://www.sandberg.it)



### USB Anschlussmöglichkeit

**133-78 USB auf Netzwerk Konverter**

- Netzwerkanschluss Verbindung für USB
- Einfach zu installieren

**133-65 Micro WiFi USB Kopierschutzstecker**

- WiFi aktiviert ihren PC
- Verbindet beliebig drahtlose Netzwerke
- Winzig kleines Format – Große Leistung

**133-81 Nano Bluetooth 4.0 Kopierschutz**

- Winzig kleines Format – Große Leistung
- Sollte ein Teil ihres Notebooks werden

**133-33 USB auf Klang Anschluss**

- USB Verbindung auf Standard Kopfhörer
- Nutzen sie ihre PC Audio Anschlüsse für andere Geräte
- Unverzügliche Installation, keine Treiber notwendig

**133-72 USB 3.0 Hub 4 Ports**

- USB 3.0 Verbindung für eine rasant schnelle Datenübertragung
- 4 Extra Anschlüsse für ihren PC
- Bis zu 5 Gb/sec
- Netzteil inklusive

**133-82 USB 3.0 Hub 7 ports**

- USB 3.0 Verbindung für eine rasant schnelle Datenübertragung
- 7 Extra Anschlüsse für ihren PC
- Bis zu 5 Gb/sec
- Netzteil inklusive
- Schnell Ladeanschluss für mobile Geräte

### The Sandberg Guide

Lassen sie sich von unserem Berater helfen

Sie haben zwei Geräte die sie verbinden möchten. Wir haben Artikel die sie dazu benötigen. Der Sandberg Berater wird Ihnen helfen, die entsprechenden Artikel zu finden. Ganz einfach:

1. Markiere die Geräte welche verbunden werden sollen.
2. Kennzeichnen Sie die Anschlüsse die zur Verfügung stehen.
3. Der Sandberg Guide zeigt Ihnen wie man die Geräte verbinden kann.

Nicht mehr verwirrt sein wegen sovieler ungewöhnlicher technischer Eigenschaften. Besuchen sie den Sandberg Berater unter [www.sandberg.it](http://www.sandberg.it) oder implementieren sie diesen in Ihrem eigenen Webshop.

## ACCESSORIES



40w  
langes Kabel

- 8A
- Ultra quick charge
- Incorporated IC
- USB x5
- 110/220V Universal

5-Port-USB-Ladegerät • Leistung: 8A • 150cm Kabel

**CHSTATION8A**



Bluetooth® 3.0  
3.5mm  
Smartphones MP3/MP4  
Autonomy 8-10h

BROADCAST YOUR MUSIC!

Den Bluetooth Adapter einfach über das 3,5 mm Klinkekabel mit einem Nicht-Bluetooth-Gerät verbinden, und schon kann man Musik vom Smartphone oder Tablet übertragen.

**BTADAJ1**



10w

- 2A
- Quick charge
- TV/PC
- USB x2
- 110/220V Universal

2 USB Ausgänge • Leistung: 2A • EU Stecker

**CHHOME21**



10 000mAh

- 2 USB
- 2A max.
- Level of charge
- Universal

Powerbank in Stein-Optik • 10.000mAh  
• 2 USB Ausgänge • 2A • inkl. Micro-USB Kabel  
• Ladestatusanzeige • lädt Smartphones / Tablets

**PBU10400**



Smartphone Universal Roboter Only for Android® NFC®

universelle Smartphonehalterung mit NFC • geeignet für Smartphones bis 5,5" • über eine kostenfreie App werden vordefinierte Programme wie z.B. Google Maps automatisch über NFC gestartet

**UHOLDNFC1**



- Wireless
- x6
- Ergonomic buttons
- Laser precision
- Soft touch
- Charge lasted
- DPI

Ergonomische Lasermaus • kabellos • 5 Tasten

**MWERGOV**



- Wireless
- 200m Laser
- Presentation control
- No installation required
- 10m working distance
- 10m
- PC MAC Compatible
- 2.4 GHz
- 4 TASTEN
- 10mtr.

Laserpointer • Mac/PC • 2,4 GHz • 4 Tasten • 10 mtr.

**LASEREMOTE**



- Bluetooth® 4.0
- Autonomy 8h
- 1 month standby
- 2 in 1
- Multi-fuction
- Universal
- Music & calls

Bluetooth Freisprecheinrichtung • mit Clip zur Befestigung an der Windschutzscheibe • 8 Stunden Sprechzeit • Audio Streaming

**CARBTKIT1**



Hands-Free-Kit • verbinden Sie Ihr Smartphone mit dem Autoradio um Anrufe über die Lautsprecher des Autos zu empfangen • Rufannahmeknopf integriert

**CARHFKIT**



- Micro SIM -> SIM
- Nano SIM -> MicroSIM
- Nano SIM -> SIM

3 SIM Karten Adapter: • SIM -> in micro SIM • SIM -> in nano SIM • micro SIM -> in nano SIM • (Öffner für iPhones nicht inklusive)

**SIMADAPT**



- Security
- Water resistant
- High visibility
- Autonomy in flash mode 70h
- Autonomy in static mode 100h

LED-Sicherheits-Armband • guter Tragekomfort  
• 2 Modi: Dauerlicht und blinken • wasserdicht • CR2025H Batterien

**SPLED1**



- Security
- Water resistant
- High visibility
- Autonomy in flash mode 70h
- Autonomy in static mode 100h

LED-Schuh-Clip • 2 Modi: Dauerlicht und blinken • wasserdicht • CR2025H Batterien

**SPLED2**



HUB, USB und SD-Kartenleser • für Android Geräte • Micro-USB Anschluss • OTG Technologie, somit können Sie unterwegs z.B. eine Maus oder Tastatur anschließen

**CRUSB1**



universelle Smartphonehalterung  
• magnetisch • verstellbar durch einen rotierenden Kopf • für Smartphones, MP3, etc. geeignet

**CARMAG2**



- Universal microphone
- Ergonomic
- Universal
- Powerful
- 120cm
- Eco-friendly
- In-Ear Kopfhörer in Holz-Design

**ESWOOD**

## CABLE ORGANIZER

### CLIPID5

Easily organize the different cables that you are using on your desk that you are using on your desk.

This product is easy to remove.

- Compatibility : universal
- Color : yellow, red, green, blue, white



**TnB** INTELLIGENT accessories



### CLIP2MIX

Easily organize the different cables that you are using on your desk.

You are dreaming of having such a nice and tidy desk, this cable clip is the solution!

This product is easy to remove and universal with cables.

- Compatibility : universal
- Color : blue/pink/white
- Fastening : sticker



## USB-C ACCESSORIES

# USB-C



### ADATCOR

- USB-C auf USB-A Adapter
- USB 3.0
- OTG Funktion



### CBLIGHT3IN1

- USB-Kabel mit
  - Lightning
  - microUSB
  - USB-C
- laden und Datentransfer
- mit Apple Lizenz



### MWTCBK / MWTCWH

- kabellose Maus
- USB-C Receiver
- 2 Tasten & klickbares Scrollrad
- Silent Click
- kompatibel mit PC, Mac, Linux
- 1000 DPI
- Stromversorgung:  
3 AAA Batterien im Lieferumfang



### TCHDMI3IN1

- gleichzeitige Nutzung des Computer USB-C Anschluss für 4K Video Übertragung und USB Anschluss für Sync, Maus, Keyboard etc.



### TCMUSBF

- USB-C auf USB-A Adapter
- Länge: 10 cm
- USB 3.0
- bis 5GB/Sek.



### TCHDMI

- USB-C auf HDMI Adapter
- Videoauflösung: Full HD 1080p



### TCVGA

- USB-C auf VGA
- Full HD bis 1080p



### TCUSB01 / TCUSB02

- USB-C auf USB-A  
1 Meter oder
- USB-C auf USB-A  
2 Meter





# XtremeMac

## HUBS

- Perfect home office solution.
- All the ports you need to connect all your accessories to your device while saving space on your desktop.
- Double HDMI 4K.
- No power supply required.



**XWH-UIM-13**

- Add 6 ports to your newest iPad Pro and MacBook.
- Smart fixing system, perfect match to your new MacBook.
- 2 \* USB-A 3.0 for fast charge & data transfer.
- USB-C PD – charge your device through the hub.
- HDMI 4K video display.
- Support SD and Micro SD cards.
- Durable, strong aluminum structure.
- Made especially for the new iMac M1, but also compatible with any USB-C laptop & tablet.

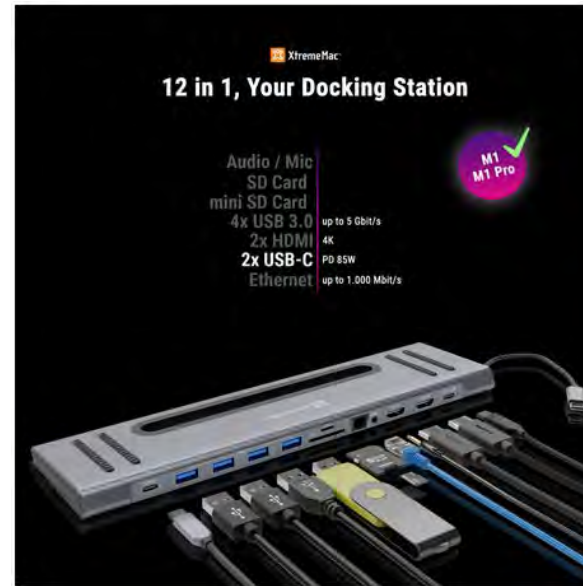

**See More, Create More**  
Resolution 3840 x 2160p

**Windows**

\*Maximum display option

**Mac**

\*Maximum display option

**Mac**  
Only 1 display extension possible!

**Type-C Docking Hub Station**  
Station d'accueil Type-C

**XWH-CDH-13**



- USB 3.0
- TYPE-C
- HDMI
- ETHERNET
- SD CARD READER MICRO SD READER
- 3.5MM AUDIO IN / OUT

TK-ACCESSORIES

## Eartips

### SednaEarfit XELASTEC



#### XELASTEC

XELASTEC is developed by AZLA's most advanced technology, through a very demanding and difficult process. Due to XELASTEC is changed the shape by body temperature, earphones or wireless earphones can be fitted securely to the ear, enabling high sound quality and comfortable listening to music.

Product's Size:SS, S, MS, M, ML, L

**An auto-fitting eartip that modifies its shape  
in reaction to the warmth of your ears**

XELASTEC uses a new material and was designed based on 778 different shapes of ears that reshapes its form according to the shape and warmth of your ears



High-quality materials from  
German Kraiburg TPE



Self-transforms according to  
the shape of the ear canal  
Comfortable and fatigue-free



Flawless sound reproduction  
Maximum seal and sound quality



#### Comfortable all the way

The elastic, flexible texture immediately  
relieves possible pressure or pain

#### Keep the sound going with quality

No leakage. A complete snug that  
improves the noise canceling  
performance from your AirPods Pro



#### Easy to install

No hassle. Installing XELASTEC to your  
Airpods Pro couldn't be simpler.

**Diese Ohrstöpsel passen sich durch die Körpertemperatur in den Gehörgang ein und schließen perfekt ab, das wirkt sich sehr positiv auf den Klang aus.**

#### Leicht zu quetschen und flexible Form.

Wenn Sie die Ohrstöpsel aus den Ohren nehmen, bleiben sie eine Zeit lang in Ihrer Ohrform.

Die **gut haftende Oberfläche** hält die Ohrstöpsel auch beim Sport in den Ohren fest.

Nicht-allergisches Material. FDA & EU10/2011 genehmigt. Sauber und gesund. Dunkle Farbe.

## AGFA PHOTO REALPIX PRINTER

### Realipix Mini P Portable Photo Printer

- Bluetooth connection
- 8-photo cartridge included
- Lithium battery
- Apple and Android compatible



### AGFAPHOTO

Printing technology	4Pass (dye sublimation)
Printing resolution	291 x 300 dpi
Printing speed	50 seconds/photo
Paper size	5.3 x 8.6 cm (2.1" x 3.4")
Image size	5.3 x 8.6 cm (2.1" x 3.4")
Printing modes via the application	Filters, decorations, stickers, and templates; Image search & print
Application	Agfaphoto Realipix
Wireless connection	Bluetooth
OS compatibility iOS:	11.0 and above,
Android:	4.2 and above
Charging	USB (Micro USB)
Battery	Built-in (620mAh, 5V/1.0A)
Battery charge time	Around 90 minutes
Autonomy	20 photos
Product dimensions	132.4 x 78.2 x 25.8 mm
Weight	255 g
Colors	White or black



The best photo quality 4Pass, also known as dye sublimation, is the best photo printing technology with over 16 million colours.

### Realipix Square P Portable Photo Printer

- Bluetooth connection
- Apple and Android compatible
- Lithium battery
- 8-photo cartridge included



Printing technology	4Pass (dye sublimation)
Printing resolution	291 x 300 dpi
Printing speed	50 seconds/photo
Paper size	7.6 x 7.6 cm (3" x 3")
Image size	7.6 x 7.6 cm (3" x 3")
Printing modes via the application	Filters, decorations, stickers, and templates; Image search & print
Application	Agfaphoto Realipix
Wireless connection	Bluetooth
OS compatibility iOS:	11.0 and above,
Android:	4.2 and above
Charging	USB (Micro USB)
Battery	Built-in (620mAh, 5V/1.0A)
Battery charge time	Around 90 minutes
Autonomy	20 photos
Product dimensions	134 x 104 x 30 mm
Weight	370 g
Colors	White or black

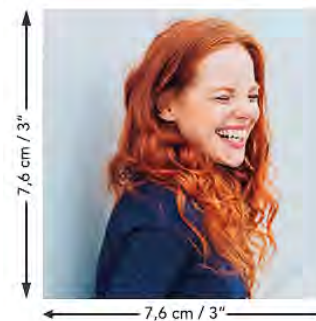

# CTA

## CAR MOUNTS

### PAD-MFSCM

#### Multi-Flex Security Car Mount

This flexible, multi-jointed tablet mount allows you to comfortably and safely display your tablet in the front seat of your car. Designed for use with commercial and passenger vehicles alike, this drill-free car mount installs easily to your vehicle's seat rail using included mounting hardware and can be safely removed at any time. The arm features two tilting, rotating joints for custom positioning, plus folding clasps to lock them in place, preventing unwanted movement when in motion. The slide-adjustable tablet holder also tilts and rotates 360 degrees for portrait and landscape orientations, protecting your tablet from theft with a powerful lock and key security system. Its unique corner-grip design prevents tablet removal when locked and allows full access to your tablet's ports, buttons, cameras, and headphone jack, for card reader compatibility. The arm mount is also equipped with an interior cable management system to permit neat tablet charging while in use.



#### Features include:

- Mounts to your vehicle's seat rail with no drilling required
- Lock and key security protects tablet from theft
- Two flexible joints on arm rotate, tilt, and lock in place for easy angle adjustment
- Tablet holder tilts and rotates 360 degrees for portrait and landscape orientations
- Unique corner-grip holder allows access to all ports, buttons and jacks
- Perfect for passenger or commercial vehicles, like taxis, delivery trucks, emergency vehicles, and more
- Interior cable routing system enables clean charging while in use
- Compatible with 7-14 inch tablets, including iPad Pro 12.9, iPad mini, iPad Air, Surface Pro 4, Galaxy Tab S3, and more

#### Package includes:

- (1) Car mount
- (1) Tablet holder
- (2) Keys
- (1) Set of mounting hardware



Locking Joints      Locking Tablet Holder      360° Rotation



### PAD-MFCM

#### Multi-Flex Car Mount

This flexible, multi-jointed tablet mount allows you to comfortably display your tablet in the front seat of your car. Designed for use with commercial and passenger vehicles alike, this drill-free car mount installs easily to your vehicle's seat rail using included mounting hardware and can be safely removed at any time. The arm features two tilting, rotating joints for custom positioning, plus folding clasps to lock them in place, preventing unwanted movement when in motion. The slide-adjustable tablet holder also tilts and rotates 360 degrees for portrait and landscape orientations. Its unique corner-grip design allows full access to your tablet's ports, buttons, cameras, and headphone jack, for card reader compatibility. The arm mount is also equipped with an interior cable management system to permit neat tablet charging while in use.



#### Features include:

- Mounts to your vehicle's seat rail with no drilling required
- Two flexible joints on arm rotate, tilt, and lock in place for easy angle adjustment
- Tablet holder tilts and rotates 360 degrees for portrait and landscape orientations
- Unique corner-grip holder allows access to all ports, buttons and jacks
- Perfect for passenger or commercial vehicles, like taxis, delivery trucks, emergency vehicles, and more
- Interior cable routing system enables clean charging while in use
- Compatible with 7-14 inch tablets, including iPad Pro 12.9, iPad mini, iPad Air, Surface Pro 4, Galaxy Tab S3, and more
- Compatible with tablet cases up to 1.06 inches in total thickness

#### Package Includes:

- (1) Car mount
- (1) Tablet holder
- (1) Set of mounting hardware



Locking Joints      Adjustable Tablet Holder      Holds Thick Cases



### PAD-GCT

#### Gooseneck Car Mount

This flexible tablet mount allows you to display your tablet at any angle in the front seat of your car. Designed for use with commercial and passenger vehicles alike, this drill-free car mount installs easily to your vehicle's seat rail using included mounting hardware and can be safely removed at any time. The flexible gooseneck can be repositioned to support your tablet at any angle while still providing enough rigidity to withstand stops, starts, and turns. The slide-adjustable tablet holder also tilts and rotates 360 degrees for portrait and landscape orientations. Its unique corner-grip design allows full access to your tablet's ports, buttons, cameras, and headphone jack, for card reader compatibility.



#### Features:

- Mounts to your vehicle's seat rail with no drilling required
- Flexible gooseneck can be repositioned for easy angle adjustment
- Tablet holder tilts and rotates 360 degrees for portrait and landscape orientations
- Unique corner-grip holder allows access to all ports, buttons and jacks
- Perfect for passenger or commercial vehicles, like taxis, delivery trucks, emergency vehicles, and more
- Compatible with 7-14 inch tablets, including iPad Pro 12.9, iPad mini, iPad Air, Surface Pro 4, Galaxy Tab S3, and more
- Compatible with tablet cases up to 1.06 inches in total thickness

#### Package Includes:

- (1) Car mount
- (1) Tablet holder
- (1) Set of mounting hardware



Flexible Gooseneck      Adjustable Tablet Holder      Holds Thick Cases



### PAD-MFSC9

#### Multi-Flex Security Car Mount

This flexible, multi-jointed tablet mount allows you to comfortably and safely display your iPad in the front seat of your car. Designed for use with commercial and passenger vehicles alike, this drill-free car mount installs easily to your vehicle's seat rail using included mounting hardware and can be safely removed at any time. The arm features two tilting, rotating joints for custom positioning, plus folding clasps to lock them in place, preventing unwanted movement when in motion. The enclosure tilts and rotates 360 degrees for portrait and landscape orientations, protecting your tablet from theft with a powerful lock and key security system, and allowing full access to your tablet's ports, buttons, cameras, and headphone jack, for card reader compatibility. The case and arm mount are also equipped with an interior cable management system to permit neat tablet charging while in use.



#### Features:

- Mounts to your vehicle's seat rail with no drilling required
- Lock and key security enclosure protects tablet from theft
- Two flexible joints on arm rotate, tilt, and lock in place for easy angle adjustment
- Tablet holder tilts and rotates 360 degrees for portrait and landscape orientations
- Enclosure allows full access to ports, buttons, cameras, and headphone jack
- Perfect for passenger or commercial vehicles, like taxis, delivery trucks, emergency vehicles, and more
- Interior cable routing system enables clean charging while in use
- Compatible with iPad Gen. 6 (2018), iPad Pro 9.7, and iPad Air

#### Package Includes:

- (1) Car mount
- (1) Security enclosure
- (2) Keys
- (1) Set of mounting hardware



Locking Joints      Locking Enclosure      Clean Cable Management



## FLOOR STANDS



### Features Heavy-Duty Security Gooseneck Floor Stand PAD-SHFS

- Height-adjusting, telescoping pole
- Ultra-flexible and sturdy gooseneck
- Tilting, 360-degree rotating tablet holder
- Attachable battery-pack cradle
- Powerful lock and key security mechanism
- 5 easily attachable and detachable swivel casters
- Compatible with 7-13 inch tablets, including iPad mini, iPad Air, iPad Pro 12.9, Surface Pro 4, and more

### Specifications

- Pole adjustment range: 21 – 35 inches
- Gooseneck length: 12 inches
- Maximum height: 58 inches
- Stand base diameter: 25 inches
- Tablet holder range: 8.625 – 15.5 inches
- Storage cradle dimensions: 3.5" x 3" x 1"
- Weight: 12.15 lbs.



### Features PAD-RPTS

- Tripod-style stand with adjustable legs and center post
- Flexible, sturdy gooseneck adjusts to any position
- Jointed tablet holder tilts side to side and rotates 360 degrees for landscape and portrait viewing
- Attachable battery-pack cradle
- Durable, easy-rolling swivel casters
- Comfortable travel bag with shoulder strap
- Compatible with 7-13 inch tablets, including iPad mini, iPad Air, iPad Pro 12.9, Surface Pro 4, and more

### Specifications

- Dimensions (fully expanded): 30" x 30" x 60"
- Dimensions (collapsed): 5.5" x 5.5" x 38"
- Tablet holder range: 8.625 – 15.5 inches
- Gooseneck length: 14.5 inches
- Adjustable height range: 30 - 60 inches
- Center post length: 10.5 inches
- Storage cradle dimensions: 3.5" x 3" x 1"
- Weight: 4.75 lbs



### Features Gooseneck Floor Stand PAD-GFS

- 15-inch Gooseneck for orientation, position and angle adjustment
- Adjustable height bar
- Four wheels for mobility
- Weighted bottom for stability
- Solid steel construction for durability
- Compatible with tablets of 6 to 8.38 inches in either width or height, like the iPad Air 2, Galaxy Note Pro and Microsoft Surface Pro 4

### Specifications

- Compatible with tablets of approximately 6 to 8.38 inches in either width or height, like the iPad Air 2, Galaxy Note Pro and Microsoft Surface Pro 4
- Maximum Height: Approximately 57 inches
- Adjustable Height of 15 inches
- Weight: 5.55 pounds
- Flexible 15-inch steel gooseneck
- Assembly required



### Features Security Gooseneck Floor Stand PAD-SCGS

- Flexible, sturdy gooseneck adjusts to any position
- Jointed tablet holder tilts side to side and rotates 360 degrees for landscape and portrait viewing
- Lock and key security system keeps your tablet protected
- Telescoping pole allows easy height adjustment
- Attachable battery-pack cradle
- Stable, weighted metal base
- Durable, easy-rolling swivel casters
- Compatible with 7-13 inch tablets, including iPad mini, iPad Air, iPad Pro 12.9, and Surface Pro 4

### Specifications

- Dimensions (fully expanded): 30" x 30" x 60"
- Dimensions (collapsed): 5.5" x 5.5" x 38"
- Tablet holder range: 8.625 – 15.5 inches
- Gooseneck length: 14.5 inches
- Adjustable height range: 30 - 60 inches
- Center post length: 10.5 inches
- Storage cradle dimensions: 3.5" x 3" x 1"
- Weight: 4.75 lbs



# Cygnett

[www.cygnett.com](http://www.cygnett.com)

10 cm or 4 meters? We can do both .... even with MFI approval!



MFI Lightning™ to USB Cable - 10cm



## CHARGER AND POWER STRIP

### EW3938

Power block Steckdoseleiste 3 Ausgänge mit 3 USB-Anschlüsse (Schwarz)  
Power block 3 USB charging ports, 3 German outlets, black



### EW1314

USB 4 port Intelligentes Ladegerät 110v-240v, 5.4A Schwarz  
USB Charger 110-240V 4 port smart charging 5.4A black



### EW1300

USB 1 port Intelligentes Ladegerät 110v-240v, 2,4 A  
USB Charger 110-240V for Smartphone 2.4A black



### EW3933

Steckdoseleiste mit individuellen Schaltern für jede von 6 Ausgänge (weiß)  
Power Strip, 6 plugs with individual on/off switches German version

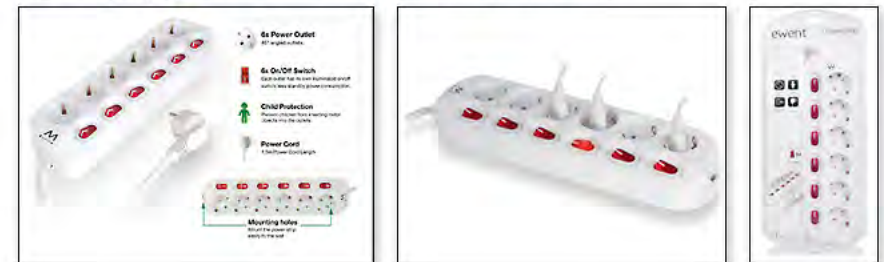

### EW1304

USB 4 port Intelligentes Ladegerät 110v-240v, 5,4 A  
USB Charger 110-240V 4 port smart charging 5.4A white



### EW3935

Desktop Steckdoseleiste 5 Ausgänge mit 2 USB-Anschlüsse (weiß)  
Power center, 2 USB charging ports, 5 German outlets, surge protection

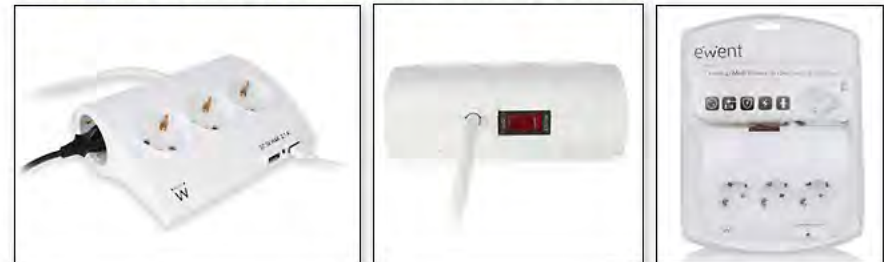



# Fixed

## Car Mounts



# Intouch

## Biodegradable range made from Wheat Straw Plastic



# Jenluca

[www.jenluca.com](http://www.jenluca.com)

## PRINTED USB CABLE



Works for  
iPhone | iPad | iPod

# Kutjo

[kutjo.com](http://kutjo.com)

## Screen Cleaner

**Kutjo K1**

**3 IN 1 CONCEPT**

- 1 Compact and elegant shell
- 2 Clean<sup>®</sup> cleaning and disinfectant lotion spray  
*Cclean*
- 3 Cleaning, polishing and washable microfibre wipe

**CLEAN YOUR SCREENS & GLASSES**

**CUSTOMIZATION TO INFINITY**

KUTJO PACK SPRAY P BLACK   KUTJO PACK SPRAY K RED   KUTJO PACK SPRAY K BLU   KUTJO PACK SPRAY P WHITE   KUTJO PACK SPRAY K GREEN



Clean your screen and make it smell good



Kits made in France cleaners and disinfectants for all your screens!  
To take care of your phone, tablet or PC, TV, or your watch, think about the stylish and rechargeable KUTJO spray.



# Monkeystick

[www.monkeystick.de](http://www.monkeystick.de)

CAMERA STICK



# Photofast

[www.photofast.com](http://www.photofast.com)

## FLASHDRIVE FOR IPHONE/IPAD

The inventor of flashdrive for iPhone / iPad

**All products are compatible with the latest iPhones (XR / Xs / Xs Max)**



Made for  
 iPhone | iPad | iPod

**iFlashDrive mini**  
 iOS microSD Card Reader



### Market leading design and technology

- iPhone X, iPhone 8 compatible card reader.
- Support up to 400GB microSDXC.
- Offload contents securely to free up space.
- Store, transfer, backup and stream data.
- Enjoy 4K media playback instantly on all your iOS devices.

### ONE APP features

**Manage file**

- Play, copy, move your video  
Play your Podcast videos
- Access Flickr albums  
Access Camera Roll photos
- Play, copy, move your music  
Access iTunes music library



**OneTouch Backup**

- One Touch Backup  
Photos / Contacts / iCalendar
- FB Album Backup
- Photos Backup
- Instagram Backup
- Contacts Backup
- Tumblr Backup
- Calendar Backup
- Flickr Backup

**Other**

- External storage
- Voice recording into file
- Zip file support

**Cloud backup**

Access/ Manage all your data between Internal storage, CR-8710 +, iCloud Drive, Dropbox, OneDrive and Google Drive

**CR-8710 +**  
 iOS SD Card Reader

Made for  
 iPod iPhone iPad



### Connection

Lightning | SD Card Reader

### Compatibility

iPhone X, iPhone 8, iPhone 8 Plus,  
 iPhone 7 Plus, iPhone 7,  
 iPhone 6s Plus, iPhone 6s, iPhone 6 Plus, iPhone 6,  
 iPhone SE, iPhone 5s, iPhone 5c, iPhone 5,  
 iPad Pro, iPad mini4, iPad Air 2, iPad mini3, iPad Air,  
 iPad mini 2, iPad mini, iPad (4th gen.),  
 iPod touch (6th gen.), iPod touch (5th gen.)

iOS 9, 10, 11

SD, SDHC, SDXC ( Low Power Mode, Up to 512GB)

### Supported Formats

#### Documents

Pages, Numbers, Keynote, doc, docx, xls, ppt, pptx, rtf, txt, html, pdf

#### Images

Jpg, png, bmp, gif, tif, tiff, ico, xbm, cur, jpeg, CR2, ref, rw2, orf, nef, nrw, minr,  
 3fr, raw, ldc, mos, met, dag, crev, paf, ppm

#### Audio

mp3, aac, aif, aiff, wav, m4a, cal

#### Video

mp4, mov, m4v (without DRM), mkv, avi, flv, rm, rmvb, wmv, vob, 3gp, H.264

#### Other

zip

### Function Comparison

CR-8710 +



	Yes	Write Data to SD card	NO
jpg, jpeg, raw, png, bmp, gif, tif, tiff, ico, xbm, cur	Image files		Jpg, jpeg, raw
mkv, avi, flv, rm, rmvb, wmv, vob, 3gp	Multiple Video files support		NO
ages, Numbers, Keynote, doc, docx, xls, xlsx, ppt, pptx, rtf, txt, html, pdf	Document files		NO
Pages, Numbers, Keynote, doc, docx, xls, xlsx, ppt, pptx, rtf, txt, html, pdf	File management functions		NO
Read   Write   Rename   Create   Delete	File exchange from Cloud to Card Reader		Read / Delete
Facebook   Tumblr   flickr   YouTube   Vimeo	Social Media File Download support		NO
Dropbox   Google Drive   iCloud   OneDrive	File exchange from Cloud to Card Reader		NO

Apple Lightning to SD Card Camera Reader



# Photofast

## 4K iREADER & PHOTO CUBE



**4K iReader**  
iOS microSD Card Reader

Up to **256GB**

- Lightning + USB 3.0 iOS microSD Card Reader.
- Up to 256GB extra storage on iPhone / iPad / iPod.
- Speed, security and reliability you can trust from the iOS storage technology leader.
- Transfer photos, contacts, calendars, music, movies, files between PC / Mac to iPhone / iPad / iPod.

**USB 3.0** Made for **iPod** **iPhone** **iPad** **PATENT REGISTERED**

- Capture and watch 4K Video at anytime anywhere
- GoPro, Drone best friend, instantly view the video on iPhone/iPad.
- More space for your large 4K Video.
- Display your memorable photo on Smart TV through high speed USB.
- Airplay through Apple TV on big screen.





## PhotoCube

**Easy to use, connect to charge and backup at the same time!**

- Backup calendar, contacts, photos and videos to prevent loss of important data.
- Auto backup when connected, no learning required!



**Ergonomically designed and fits the Apple USB charger perfectly!**

1. Insert microSD memory card
2. Connect to Apple USB charger
3. Connect Apple Lightning cable



microSD card slot  
USB connector  
PhotoCube  
Apple Lightning cable  
Apple USB charger

microSD card slot

- microSD
- microSDHC
- microSDXC

**Supported models :**

iPhone X	iPad Pro 12.9-inch (2nd generation)
iPhone 8	iPad Pro 10.5-inch
iPhone 8 Plus	iPad (3rd, 4th and 5th generation)
iPhone 7	iPad Pro 9.7-inch
iPhone 7 Plus	iPad Pro 12.9-inch (1st generation)
iPhone SE	iPad Air 2
iPhone 6s	iPad mini 4
iPhone 6s Plus	iPad mini 3
iPhone 6	iPad Air
iPhone 6 Plus	iPad mini 2
iPhone 5s	iPod touch (6th generation)
iPhone 5c	iPod touch (5th generation)
iPhone 5	

**USB 3.1**

**Swappable memory design, expand your storage with no limit!**



# Platinet

## 3-AXIS GIMBAL FOR SMARTPHONES

**S5** 3-AXIS  
ELECTRONIC STABILIZER  
FOR SMARTPHONES  
*Gimbal*



- »» Time Lapse
- »» up to 12h Runtime
- »» Panoramic Shooting
- »» Face & Object Tracking



# Prestigio

[www.prestigio.com](http://www.prestigio.com)

## Revolt A3 wireless charger



### 10W for rapid charging

The ReVolt A3 allows you to charge your devices as quickly as possible, just when you need it, as it runs at 10W power. Also, you will no longer need an ever-confusing cable and power supply because the charging station is wireless.



### Compatible with all devices that support wireless charging

The ReVolt A3 can be used to charge your smartphone, headphones, and any other gadgets that support wireless charging. This is due to the international Qi standard support. This device will be definitely appreciated by those who live fast and always want to stay connected, but have been left out of charge.

### FUNCTIONAL THROUGH SURFACES UP TO 35 MM THICK

Is the countertop made of glass, wood, plastic, or granite? The ReVolt A3 can be installed under any of the above surfaces up to 35mm thick. The charging station can be installed easily, quickly, and securely.



# Qubii

[www.maktar.com](http://www.maktar.com)

## QUBII



### Works While You Work

- Backup in the background while browsing your phone.
- Backup automatically without manually launching the app.



### Free Qubii App

Simply manage your iPhone data without computer.



Download on the  
App Store

- Check the available space.
- Browse microSD card.
- Backup all item with one click.
- Restore to iPhone with one click.



### Use as Card Reader

Use Qubii just like you would a normal flash drive.

- Once card capacity is filled, Qubii App reminds you to replace card.
- Switching to a new card doesn't duplicate the backup, instead Qubii remembers where it left off and picks back up from there.
- Just connect Qubii to your computer or TV USB port & view your photos and videos.

#### HOW IT WORK

### Easy & Speedy Backup

Only 3 Steps and You're Ready to Go!



Insert microSD memory card into Qubii



Plug Qubii into iPhone adapter | charger



Plug cable into Qubii USB port and iPhone

### Specification

- **Product Size:** 2.5x2.5x4.5cm
- **Package Size:** 6.5x12.5x4cm
- **Color:** White/ Pink
- **Operating System:** iOS 10.x / MacOS X / Windows 8/7/XP
- **Supported Model:**  
iPhone Xr, iPhone Xs, iPhone XS Max, iPhone X, iPhone 8, iPhone 8 Plus, iPhone 7, iPhone 7 Plus, iPhone SE, iPhone 6s, iPhone 6s Plus, iPhone 6, iPhone 6 Plus, iPhone 5s, iPhone 5c, iPhone 5  
iPad Pro (12.9-inch), iPad Pro (9.7-inch), iPad mini 4, iPad Air 2, iPad mini 3, iPad Air, iPad mini 2, iPad mini, iPad (4th generation)



## PICONIZER 2

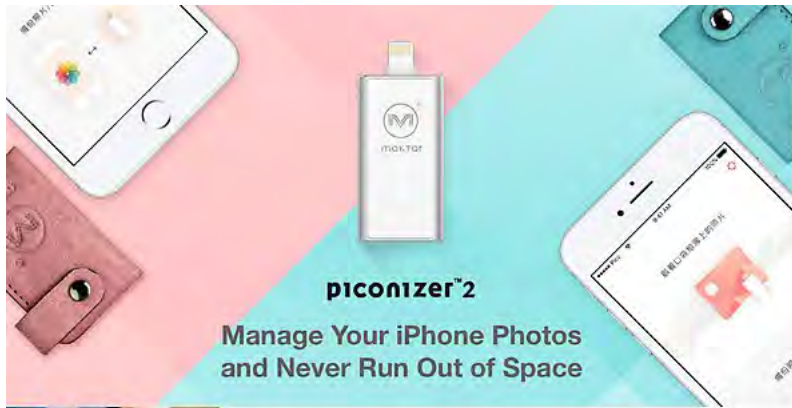

### piconizer™2

Manage Your iPhone Photos and Never Run Out of Space



### Simple and chic! Instant Plug-n-Play Storage

- ✦ Excellent way to backup and restore your photos & videos with one click. No setting need to worry about.
- ✦ The best solution to transfer or remove all your photos & videos. Get extra space immediately.

“Freeing Up iPhone Capacity Has Never Been Easier”



**Step 1. Plug in**  
Plug in the Piconizer and launch the app.



**Step 2. Backup**  
Backup all your iPhone photos & videos, or simply select the ones to transfer.



**Step 3. Unplug & Enjoy**  
Once the transfer is done, unplug it and you're ready to go.

### Enjoy Anytime, Anywhere Watch Movies On the Go

Store videos larger than 4GB with the support of exFAT format. Play HD movies or high quality videos while you are traveling.

✦ Works with: mov, mp4, m4v, mkv, avi, mp3, wav



### Get Extra Space Immediately

### Backup to Piconizer 2 Directly

With the App, you can choose to take photos, record voice or 4k videos directly to Piconizer 2 storage - without taking up a byte on your phone memory.



### Hardware Design

### High Quality

“ We ensures your devices are safe and reliable without any risk of overheating or damage.”



### Friendly Design & Easy to Use

### Works Like Your iPhone Camera Roll

- ✦ Keep your pictures in order. Photos and videos are being organized by year, month and date.
- ✦ Export into individual albums. Photos from trips and events can easily be grouped into albums, and browse them on any iPhone, iPad, Mac or PCs.

Lightning connector bought from APPLE.

Include the trustable microSD card from International Brand.



MFi Certified

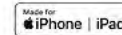

We are uniquely licensed and certified by Apple to ensure 100% compatibility with any Apple lightning devices.

Aluminum Design

## Display Adapter Hub / HDMI Switch

- 4-in-1 Hub
- HDMI 2.0 Switch

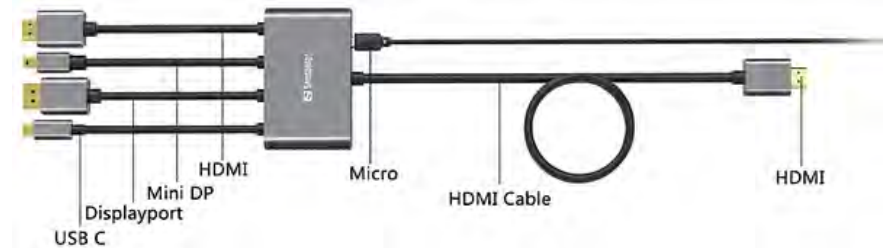
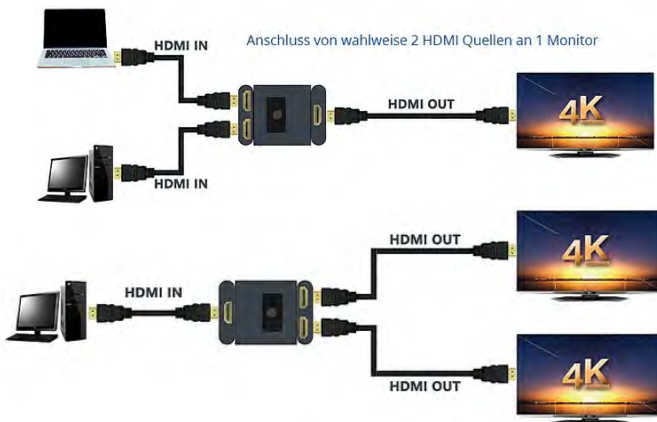

# Scosche

## FLYTUNES

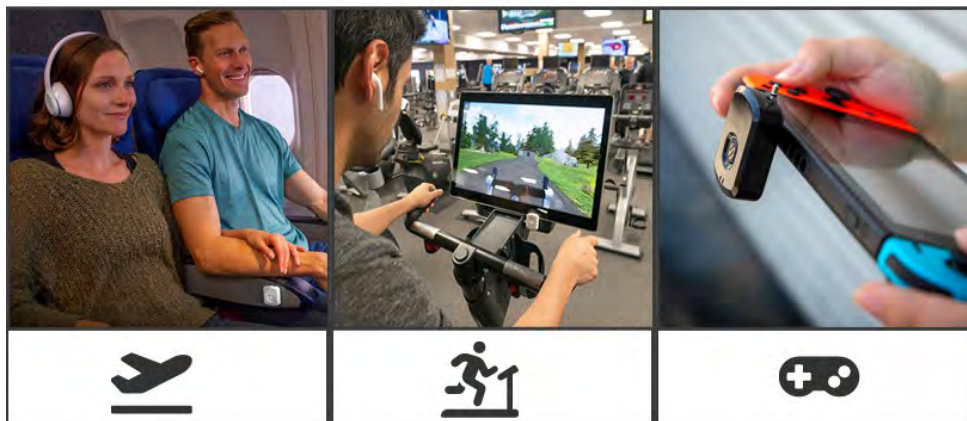

# Scosche

[www.scosche.com](http://www.scosche.com)

## Qi MOUNTS

**#1 Mount Manufacturer In US**  
**#1 Mount Manufacturer In Europe**

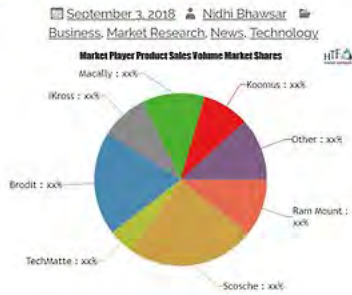
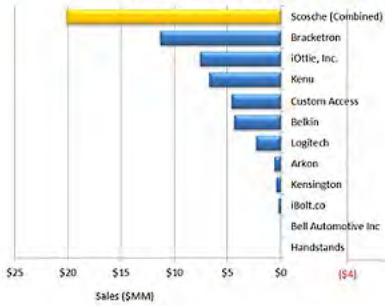

## Qi Mounts



Qi Mount  
 Input: 5 VDC, 2A  
 Output: 5W - 10W  
 Car adapter  
 Input: 12 - 24 VDC  
 Output: 5 VDC, 2A



WIRELESS  
 Fast-Charge  
 Apple  
 Samsung



### MAGICMOUNT™ PRO CHARGE WINDOW / DASH

- Wireless Charging Magnetic Window/Dash Mount**
- Wirelessly charge Qi compatible smartphones without the need to plug your device into a car charger or USB cable.
  - Wirelessly charge at 5W or 10W Adaptive Fast Charging.
  - Safely secure your mobile device to your vehicle's window or dash.
  - The high powered neodymium magnets are 100% safe and will not damage your device.
  - StickGRIP™ suction base provides a strong hold to any window or dash.
  - 360° adjustable design for viewing at different angles.
  - Qi certified by WPC (Wireless Power Consortium) to support wireless charging on all Qi enabled devices.
  - Works with Qi enabled smartphones from these manufacturers: Apple, Samsung, Google, Microsoft, LG, HTC, Motorola, Sony and Blackberry. Also works with Qi enabled cases, receivers, and battery covers.
  - Includes USB car adapter and micro USB cable.

MODEL: MPQ2WD-XTSP



Includes 2 MagicPLATEs with 3M adhesive



Includes USB car adapter and micro USB cable



Qi Mount  
 Input: 5 VDC, 2A  
 Output: 5W - 10W  
 Car adapter  
 Input: 12 - 24 VDC  
 Output: 5 VDC, 2A



Includes 2 MagicPLATEs with 3M adhesive

Includes USB car adapter and micro USB cable



Qi Mount  
 Input: 5 VDC, 2A  
 Output: 5W - 10W  
 Home adapter  
 Input: 100-240VAC  
 Output: 12VDC/2.5A



Includes 2 MagicPLATEs with 3M adhesive



Includes USB home adapter and micro USB cable



Low Profile Dash mount option included

# Scosche

[www.scosche.com](http://www.scosche.com)

## MOUNTS





## Natural rope braided cable

- Eco Materials
- Gold plated connectors
- Triple shielded

MADE WITH **ECO MATERIALS**



54% bioplastic



Rope made with 100% cotton



**Ecological and minimalistic packaging**



## Vlogger + Inledtrip



Ultra light and compact mini tripod with integrated smartphone holder on the screw thread, compatible with smartphones up to 6.5".

360 rotating tripod with LED projector

3 adjustable light intensity options with the integrated button to select the best brightness.

The feet ensure the stability of the device and your images.

Power supply: 2 AAA batteries (not included)

Compatibility: smartphones up to 6.5"

Height: 20cm

Color rendering index: 70 Ra

Lumens: 24-26 Lumens

Number of LEDs: 12

Net weight: 120g (138g with package)

Max power: 2.4 W

Color temperature: 7000k - 7500k

## Multimedia Vlogger video pack



Full pack of accessories to enhance videos : tripod , smartphone holder, microphone, LED flash and bluetooth remote.

The compact tripod will keep videos stable inside and outside.

The bluetooth remote stored in the tripod will trigger videos remotely.

The smartphone holder is also compatible with compact cameras and sport cameras.

A wired microphone for sound recording and a LED flash (3 filters included) for a professional content of videos are included

LED flash : USB / micro USB cable

Remote : included CR2025

cell + Bluetooth connection

Tripod

height : 23,5cm

Microphone :

wired with included CR2 cell

Gross weight : 479g

Net weight : 348g

Max weight : 3 kg



# Whoosh

[www.whoosh.com](http://www.whoosh.com)

## SCREEN SHINE

MAKES SCREENS UP TO **15X STRONGER**

# WHOOSH! DIAMOND DEFENSE™/HC

**LIQUID SCREEN PROTECTION**

-  SUPERIOR SCRATCH RESISTANCE
-  FITS ALL SMARTPHONES
-  INVISIBLE + EASY TO APPLY
-  NO BUBBLES

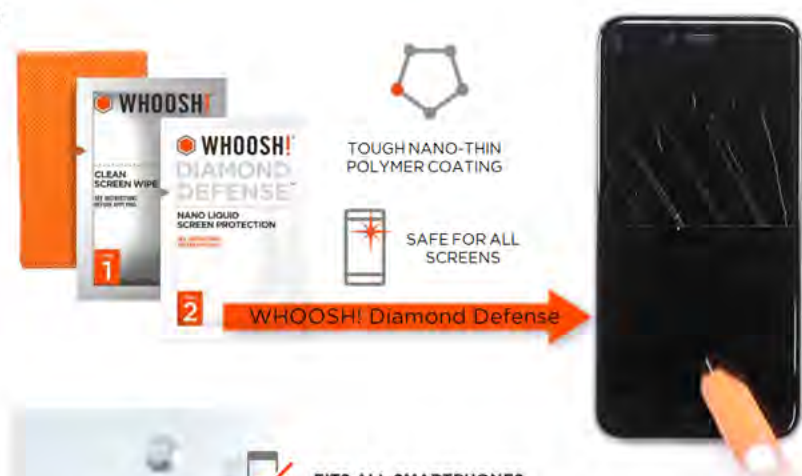

1. CLEAN SCREEN WIPE

2. WHOOSH! DIAMOND DEFENSE NANO LIQUID SCREEN PROTECTION

TOUGH NANO-THIN POLYMER COATING

SAFE FOR ALL SCREENS

WHOOSH! Diamond Defense

## Displayschutz ohne Folie oder Glasschutz.

Die fortschrittliche Technologie von Diamond Defense erzeugt eine starke, hydrophobe, nano-dünne Beschichtung auf dem Screen, die nicht gesehen oder gefühlt werden kann. Partikel, die mit der behandelten Oberfläche in Kontakt kommen, prallen ab und rutschen von der unsichtbaren Beschichtung ab. Sie bieten eine hervorragende Widerstandsfähigkeit gegen Kratzer und Späne und minimieren den Schaden, der durch die alltägliche Abnutzung verursacht wird.

Diamond Defense ist wasserbasiert und **enthält KEIN Titanium Dioxid**. Andere Flüssigscreens Schutzmittel enthalten teilweise sogar Stoffe, die auf der Liste krebserregender Stoffe (z.B. Titanium Dioxid) stehen.

Zitat aus science media center vom 14.06.2017  
*Titandioxid als möglicherweise krebserregend eingestuft*  
<https://www.sciencemediacenter.de/alle-angebote/rapid-reaction/details/news/titandioxid-als-moeglicherweise-krebserregend-ingestuft/>

und von der IARC  
*Titanium dioxide has recently been classified by the International Agency for Research on Cancer (IARC) as an IARC Group 2B carcinogen "possibly carcinogen to humans". Titanium dioxide accounts for 70% of the total production volume of pigments worldwide. Mar 6, 2013*



FITS ALL SMARTPHONES

SUPERIOR SCRATCH-RESISTANCE

NANO THIN POLYMER COATING

SAFE FOR ALL SCREENS

RESISTS FINGERPRINTS

WHOOSH! DIAMOND DEFENSE

LIQUID SCREEN PROTECTION

LIQUIDE DE PROTECTION D'ECRAN

HITFAR BUZZ

Whoosh! Diamond Defense – The Liquid That Makes Your Screen 15x Stronger

# Whoosh

[www.whoosh.com](http://www.whoosh.com)

## SCREEN SHINE

# WHOOSH!

• TECH HYGIENE •

**MAKE CLEAN  
SCREENS THE ROUTINE**

# WHOOSH!

• TECH HYGIENE •

**LEAVES YOUR SCREEN  
99.99% CLEAN!**

**SAFE  
FOR ALL  
SCREENS!**



**Alcohol and Ammonia free.**  
There's nothing in this bottle that will damage, etch or harm any of your screens.

**NON-TOXIC,  
ODORLESS &  
ECO-FRIENDLY.**



WHOOSH! is **100% safe** for you and your family. No harmful residue left behind.

**RESISTS  
FINGERPRINTS.**



Our proprietary formula leaves a nano-thin, anti-static, invisible coating that **repels** and **resists** dust, smudges and fingerprints. (Yep, really!)

**ANTIMICROBIAL  
MICROFIBER CLOTH.**



Using WHOOSH! with our ultra-soft W! **antimicrobial** treated microfiber cloth makes your devices clean and shining like new.



## 30mL

**INCLUDES:**  
1 fl. oz. / 30 mL BOTTLE  
6"X6" ANTIMICROBIAL MICROFIBER CLOTH

**LEAVES YOUR SCREEN  
99.99% CLEAN!**



8mL



50mL



100mL



100mL + 8mL

WHOOSH! Screen Shine	
CERTIFIED - 99.9% clean	✓
TESTED - Safe for Screens	✓
Ammonia & Alcohol Free	✓
Non-Toxic	✓
Resists Fingerprints	✓
Includes Anti-microbial microfiber cloth	✓
Certified Eco-Friendly	✓
100% Re-usable & Recyclable Packaging	✓
High Turns & Self-through	✓



# TV-MOUNTS & ACCESSORIES

# Meliconi

[www.meliconi.com](http://www.meliconi.com)

## TV REMOTES



# Multibrackets

[www.multibrackets.com](http://www.multibrackets.com)

## Home Office Mounts



# Multibrackets

## Wall Mounts

Up to 85"

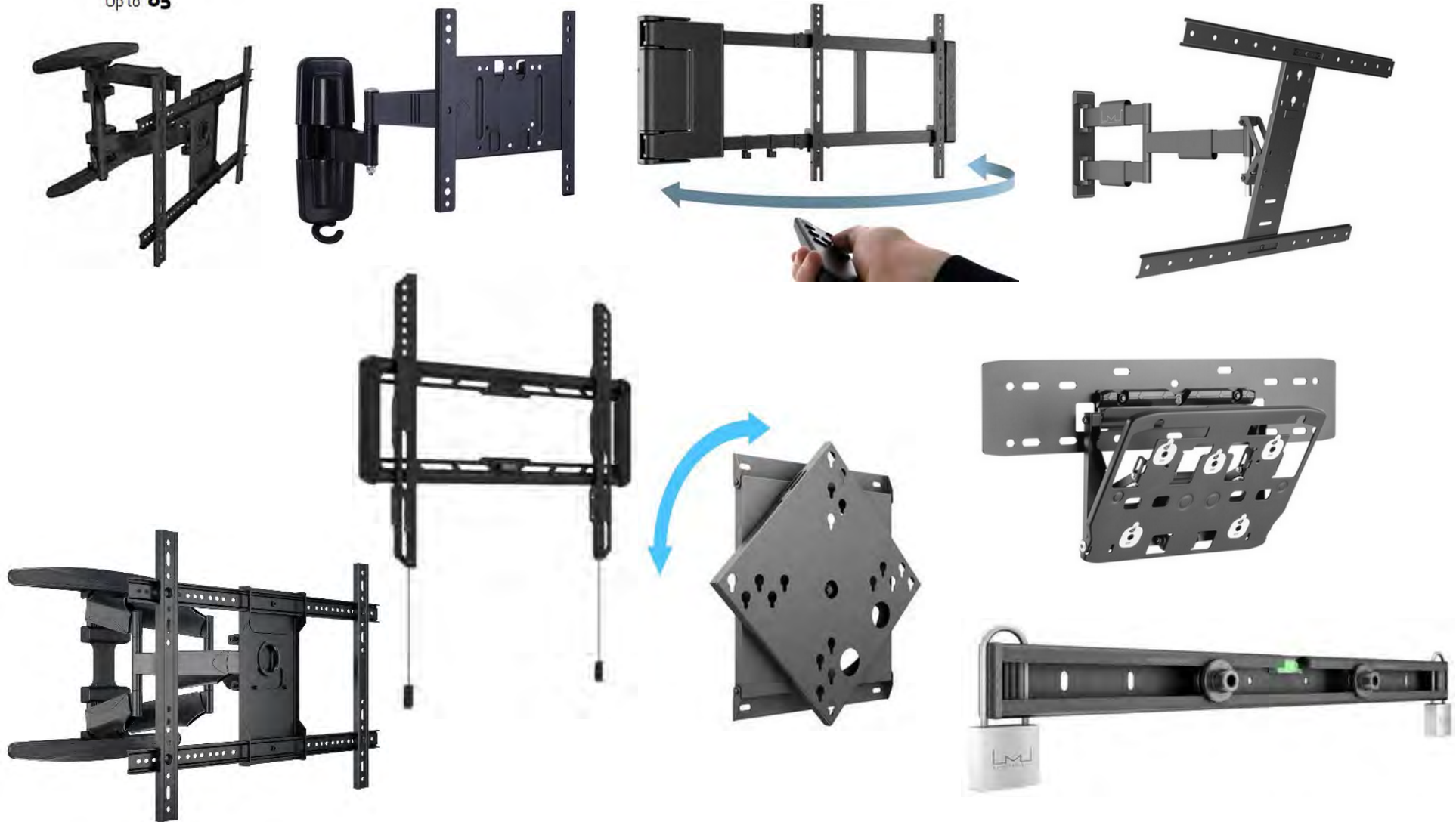



# Multibrackets

[www.multibrackets.com](http://www.multibrackets.com)

## Floorstands

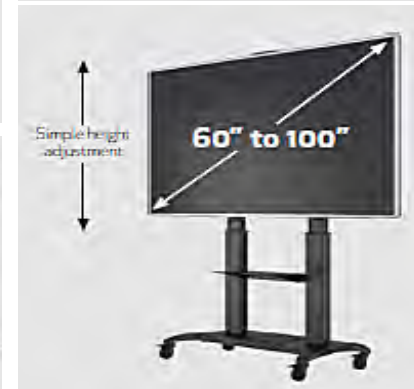
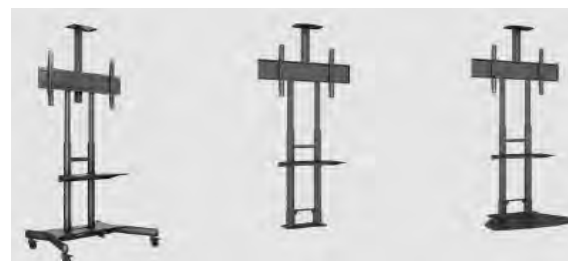
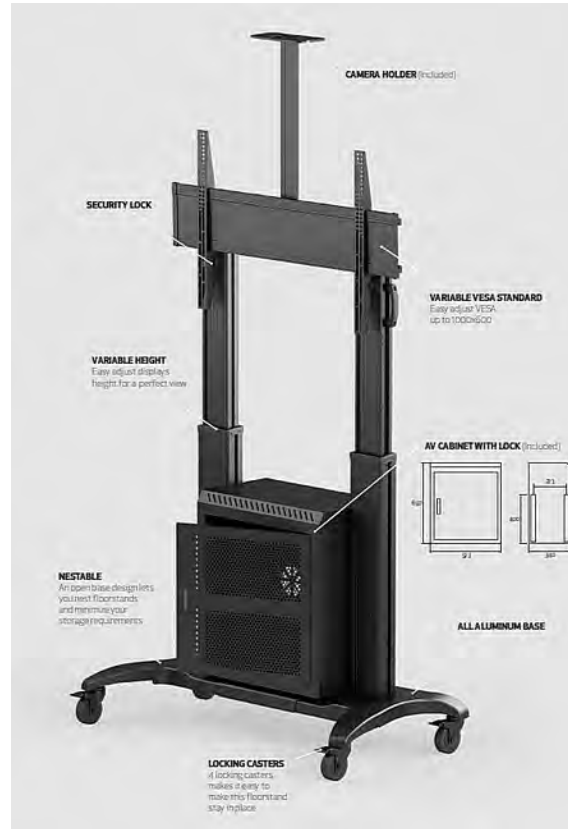

# Sbox

[s-biz.biz/mounts/](http://s-biz.biz/mounts/)

## Wall Mounts



## HOME VIDEO/TV ACCESSORIES

### INDOOR ANTENNAS

DARK FLAT | Ultra flat / Ultra plate



### CLEANING

ECOCLEAN | Biodegradable spray for screens / Spray biodégradable pour écrans

100% biodegradable. Plant based active ingredients. Flammable, pH 6.5, glycol ether and formaldehyde free. Packaging is 100% recyclable. Efficient and long term.



HUMID WIPES | Lingettes pré-impregnées



DVD LENS CLEANER | DVD de nettoyage

300x rotation guide. DVD de nettoyage avec guide rotationnel.



### COOLING PAD | Support refroidissant

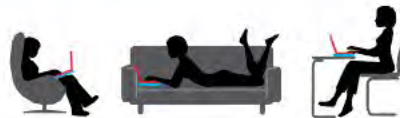

### AUDIO JACK CABLE | Câble audio jack

To connect an MP3 player, smartphone to Hi-Fi, an amplifier ... Pour relier un lecteur MP3, smartphone à une chaîne Hi-Fi, un amplifi...



### COAXIAL CABLE | Câble coaxial

To connect your wall socket to your Fusionbox or a TV equipped with DTT. Réseaux. Pour relier vos prises coaxiales à votre décodeur DTT ou votre TV équipée de la DTT.



### USB 3.0 CABLE | Câble USB 3.0

To connect the USB socket to all your devices. Pour relier les sockets USB de tous vos appareils.



### CHARGER

MAINS CHARGER + 2 USB | CHARGEUR SECTEUR + 2 USB

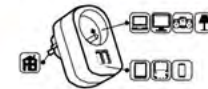

SURGE PROTECTOR + 2 USB | PRISE PARAFoudre + 2 USB



4 USB POWER STATION | STATION DE RECHARGE 4 USB



### REMOTE CONTROL

EASY LINE | Universal / Universelle

Easy programming. Guaranteed compatibility with more than 1000 brands. Facile à programmer. Compatibilité garantie avec plus de 1000 marques.



OTHER ACCESSORIES

MT-B01



Smart.Cook  
Model: MT-B01



## Wireless Smart Meat Thermometer



### Specification

Cooking Temperature Real-Time Monitoring; Temperature per Fixed Time; Timing Alarm Reminder	
Model Number:	MT-B01
Wireless Type:	2.4GHz (Bluetooth BLE 4.0)
Wireless Range:	Up to 10 meters
Battery:	Dedicated Electronic Circuits
Precision:	$\pm 1$ °C
Waterproof:	Water resistant
Cooking Temperature:	Up to 300 °C in oven, with probe properly inserted into the meat
Operation Time:	Up to 4 hours for cooking (depending upon the oven temperature)
Charging Time:	About 3 minutes for "fully charge" with dedicated charger
Dimension (metal probe):	Length: 80 mm; Diameter : 6 mm
Weight:	About 17 g
Operating System:	iOS version 10.3.3 or above; Android version 6.0 or above
Multiple Probe:	up to 8 probes with one mobile phone



Charger Box

# Fuseall

## Schaumklebeband



### Fuseall™ **General Purpose** Wraps

bieten hervorragende thermische Eigenschaften, Schwingungsisolierung, elektrische Isolierung und ein weiches, taktiles Verhalten, das sich für nahezu jede Situation eignet.

Beschreibung:  
1 in x 0,06 (1,5 mm) x 8 ft (2,44 m) / Rolle  
für Umgebungen unter 260 C° (500 F°)



### Fuseall™ **Outdoor / Sport** Wraps

bieten hervorragende thermische Eigenschaften, Vibrationsisolierung, elektrische Isolierung und eine weiche, taktile Reaktion, die für nahezu jede Situation perfekt ist.

Beschreibung:  
1 in x 0,06 (1,5 mm) x 8 ft (2,44 m) / Rolle  
für Umgebungen unter 260 C° (500 F°)

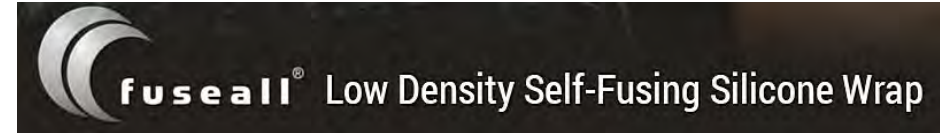

### Fuseall™ **High-Temperature Military** Wraps

bieten hervorragende thermische Eigenschaften, Schwingungsisolierung, elektrische Isolierung und ein weiches, taktiles Verhalten, das sich für nahezu jede Situation eignet.

Beschreibung:  
1 in x 0,06 (1,5 mm) x 8 ft (2,44 m) / Rolle  
Hochtemperatur für Umgebungen unter 316 C°  
(600 F°)



## LIGHTNING ATMOSPHERA KIDS

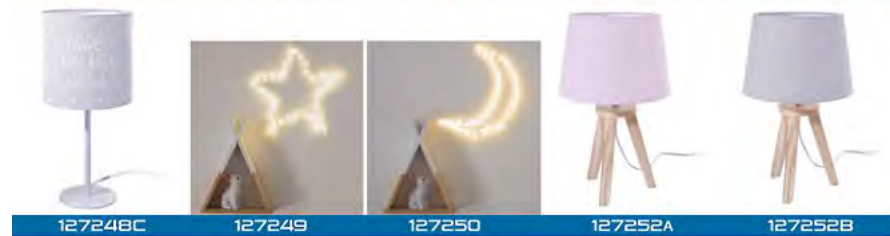
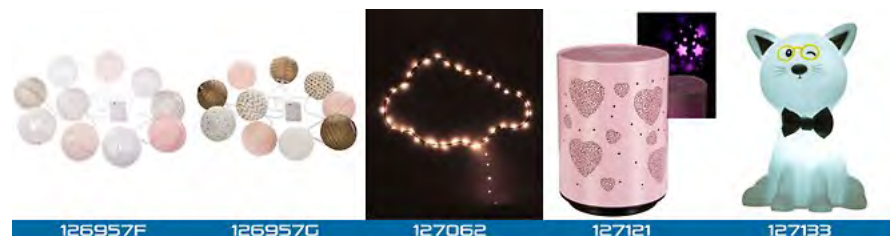

# Lexibook

## LIGHTNING FOR KIDS



**NLJ001PA1**  
**Chase Pocket Night Light**  
 Pocket night light to help kids to sleep with their favourite character!

- Energy-efficient LED Lights, providing a smooth and reassuring lighting.
- Colour change feature.
- Shockproof material safe for kids.
- 13 cm pocket size to bring them everywhere!
- Available in 3 characters: Chase, Marshall and Skye....collect them
- Packaging type: Window box
- Power supply: 3 x LR44 (included)



**NLJ008**  
**Unicorn Colour Nightlight**  
 The perfect night light for your child bedroom!

- Energy-efficient LED light, provides a smooth and reassuring lighting.
- Shockproof material safe for kids.
- Select among 2 modes:
  - White color light.
  - Rainbow color changing light: blue, yellow, pink.
- Select between continuous light and auto-off feature after 10 minutes to save energy.
- Power supply: 3 x AA/LR6 (not included) or micro USB cable (included).
- Dimensions : 14,3 x 13,7 x 21,5[-l] cm



**NLJ001PJM**  
**Catboy Pocket Night Light**  
 Pocket night light to help kids to sleep with their favourite character!

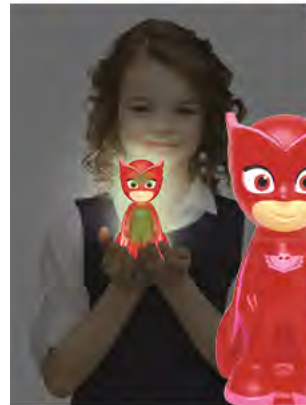

**NLJ001PJM2**  
**Owlette Pocket Night Light**  
 Pocket night light to help kids to sleep with their favourite character!

- LED light, provides a smooth and energy-saving light.
- Color change.
- Shockproof material safe for kids.
- 13 cm approximate height, a compact size to always have it in your pocket!
- Available in 3 characters: Catboy, Owlette and Gekko....collect them all!
- Power supply: 3x LR44 (included)



**NLJ005**  
**Dog LED Night Light**

- Cute design, perfect as night light for kids rooms
- Energy-efficient LED light, allows to keep it lightened longer
- Choose among 3 colors and white light to create the ambiance you want
- Shockproof material
- Battery operated : 2x AA (not included)



Gekko



Owlette



**NLJ005PJM**  
**PJ Masks® LED Colour Night**

- Energy-efficient LED light, provides a smooth and reassuring lighting.
- Great PJ Masks design!
- Shockproof material safe for kids.
- Select among 2 modes:
  - White color light.
  - 3-colour change: red, blue and green!
- Select between continuous light and auto-off feature after 10 minutes to save energy.
- Power supply: 3 x AA/LR6 (not included) or micro USB cable (included)
- Product size: 22 cm height.



**NLJ030PJM**  
**Night Light PJ Masks®**

The perfect projector to send children to sleep under cute icons of their favorite PJ Masks heroes!

The night light projects nice and soft colored icons on the ceiling to soothe your children before bedtime.

- Relaxing: it's nice and soft colored icons will soothe to bed both the older and the younger ones
- Dynamic and multicolor: it rotates slowly by projecting the PJ Masks heroes on the walls... perfect to take child gently to dreamland. It projects their favorite characters in 3 colours for a happy child.
- Energy saver: long-duration battery
- Packaging: Closed Box
- Power supply: 3 x 1.5V LR06/AA (not included)



Catboy



# Platinet

## DESK LAMP

[www.platinet.eu](http://www.platinet.eu)



**PLATINET BUSINESS LED LAMP**

LED DESK LAMP  
Date & Time  
Snooze Function  
Temperature  
Charger Included

5500K  
COLOR TEMPERATURE

🔌	📶	🕒	🕒
5500K	36	🕒	🕒
📶	10W	🕒	🕒
IP20	🔌	🕒	🕒
🔌	PF >0.5	🕒	🕒
🕒	>80 Ra	🕒	🕒
🕒	0,1m	🕒	🕒

PDLH1

**MODERN LED DESK LAMP**

3-STEP DIMMER  
TOUCH CONTROL  
FLEXIBLE FRAME  
CHARGER INCLUDED

2in1  
USB & BATTERY TABLE  
ADJUSTABLE LED LAMP

5500K  
COLOR TEMPERATURE

🔌	📶	🕒	🕒
5500K	45	🕒	🕒
📶	12W	🕒	🕒
IP20	🔌	🕒	🕒
🔌	PF >0.5	🕒	🕒
🕒	>80 Ra	🕒	🕒
🕒	0,1m	🕒	🕒

12W  
5500K

CE RoHS

**BLUETOOTH SPEAKER LED LAMP**

FLEXIBLE FRAME  
BUILT-IN HIGH POWER 7W SPEAKER  
BLUETOOTH  
AUX-IN CONNECTION  
DIMMABLE

5500K  
COLOR TEMPERATURE

🔌	📶	🕒	🕒
5500K	36	🕒	🕒
📶	12W	🕒	🕒
IP20	🔌	🕒	🕒
🔌	PF >0.5	🕒	🕒
🕒	>80 Ra	🕒	🕒
🕒	0,1m	🕒	🕒

12W  
5500K

Size: 120x230x100mm - Weight: 0,80kg

**PLATINET BUSINESS LED LAMP**

Date & Time  
Snooze Function  
Temperature  
Charger Included

5500K  
COLOR TEMPERATURE

🔌	📶	🕒	🕒
5500K	36	🕒	🕒
📶	12W	🕒	🕒
IP20	🔌	🕒	🕒
🔌	PF >0.5	🕒	🕒
🕒	>80 Ra	🕒	🕒
🕒	0,1m	🕒	🕒

48  
7W

120x230x100mm - Weight: 0,80kg

PDL021

**BRUSH POT LED LAMP**

FLEXIBLE FRAME  
CHARGER INCLUDED

5500K  
COLOR TEMPERATURE

🔌	📶	🕒	🕒
5500K	45	🕒	🕒
📶	12W	🕒	🕒
IP20	🔌	🕒	🕒
🔌	PF >0.5	🕒	🕒
🕒	>80 Ra	🕒	🕒
🕒	0,1m	🕒	🕒

6,5W  
5500K

**PLATINET BRUSH POT LED LAMP**

LED DESK LAMP  
Date & Time  
Snooze Function  
Temperature  
Charger Included

5500K  
COLOR TEMPERATURE

🔌	📶	🕒	🕒
5500K	36	🕒	🕒
📶	12W	🕒	🕒
IP20	🔌	🕒	🕒
🔌	PF >0.5	🕒	🕒
🕒	>80 Ra	🕒	🕒
🕒	0,1m	🕒	🕒

7W  
5500K

Size: 110x180x220mm - Weight: 0,55kg

**PLATINET BUSINESS LED LAMP**

LED DESK LAMP  
Date & Time  
Snooze Function  
Temperature  
USB Charger

3000K-6000K  
COLOR TEMPERATURE

🔌	📶	🕒	🕒
3000K-6000K	36	🕒	🕒
📶	14W	🕒	🕒
IP20	🔌	🕒	🕒
🔌	PF >0.5	🕒	🕒
🕒	>80 Ra	🕒	🕒
🕒	0,1m	🕒	🕒

LEATHER  
TEXTURE

USB CHARGING  
PORT

PDL013

# Platinet

## COSMETIC MIRROR WITH LED LIGHTNING



### COSMETIC MIRROR WITH LED LIGHTING

**PLATINET PMLT6W** is a combination of mirror and LED light with adjustable light intensity. Adjustable stand allows for proper setting, as well as a total folding for convenient transportation.

### PRECISE MAKEUP

Forget about bad lighting that makes makeup impossible. LED lighting in our mirror will brighten your face and allow you to see more details.

### ACCESSED TO YOUR NEEDS

At the bottom of the mirror there is a touch button whose short touch activates or deactivates the lighting, while the longer, 3-second holding allows you to adjust its brightness.

### IN ANY PLACE

In the **PLATINET PMLT6W** cosmetic mirror there is a 600 mAh battery that allows you to use mirror independently of the presence of electrical sockets. On the back of the mirror you will find a microUSB connector, so you can charge it with a traditional smartphone charger.

### COMFORTABLE ADJUSTMENT

**PLATINET PMLT6W** cosmetic mirror is equipped with a comfortable stand that allows adjustment at a 180-degree angle.

### TECHNICAL SPECIFICATIONS

Dimensions: 203x135x39 mm  
Weight: 212 grams  
Housing: ABS material + glass  
Lighting: 18 LED SMD2835, 80 lumens, 3W  
Battery: 600 mAh, Lithium  
Power supply: MicroUSB, 5V, 1A  
Included: **PMLT6W** mirror, USB cable, manual

### COSMETIC MIRROR WITH LED LIGHTING

**PLATINET PMLY7W** is a combination of mirror and LED light with adjustable light intensity. Adjustable stand allows for proper setting and it can act as a shelf for small cosmetics.

### PRECISE MAKEUP

Forget about bad lighting that makes makeup impossible. LED lighting in our mirror will brighten your face and allow you to see more details.

### ACCESSED TO YOUR NEEDS

At the bottom of the mirror there is a touch button whose short touch activates or deactivates the lighting, while the longer, 3-second holding allows you to adjust its brightness.

### IN ANY PLACE

In the **PLATINET PMLY7W** cosmetic mirror there is a 600 mAh battery that allows you to use mirror independently of the presence of electrical sockets. On the back of the mirror you will find a microUSB connector, so you can charge it with a traditional smartphone charger.

### COMFORTABLE ADJUSTMENT

**PLATINET PMLY7W** cosmetic mirror is equipped with a comfortable stand that allows adjustment at a 180-degree angle.

### TECHNICAL SPECIFICATIONS

Dimensions: 162x162x291 mm  
Housing: ABS material + glass  
Lighting: 24 LED SMD, 80 lumens, 4W  
Battery: 600 mAh, Lithium  
Power supply: MicroUSB, 5V, 1A  
Included: **PMLY7W** mirror, USB cable, manual

# Promate

## TOUCH CONTROL KIDS TABEL AND NIGHT LED LAMP

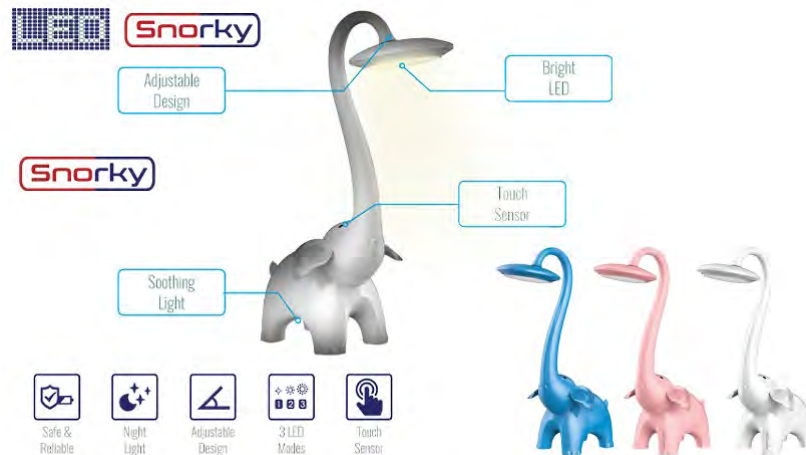

# Tredan

## USB TRAVELLER PLUG

**80 cm cable exactly the right length**

So everything fits on the table. All devices are easy to reach and operate.

2 x USB 5V/2,1A  
2 x 100V-240V  
80 cm power cable

# PROMOTIONAL ITEMS

# Addex CLOCKS

### METEO



**Ref. T2000**  
RÉVEIL & STATION MÉTÉO / ALARM CLOCK & WEATHER STATION

- Affichage LED bleu / Blue LED display
- 10 touches / 10 keys
- Adaptateur secteur 220V / 220V AC adaptor
- Pile de sauvegarde incluse / Back-up battery included
- Dim. 200 x 66 x 40 mm

### SHINY



**Ref. T2000**  
RÉVEIL & STATION MÉTÉO / ALARM CLOCK & WEATHER STATION

- Alarme électrolytique / Electrolytic alarm
- Précision atmosphérique / Atmospheric precision
- 48h Weather Forecast
- Calendrier / Calendar
- Chronomètre avec éclairage quatuor / Day/Night backlight
- Face amovible pour Black glass front panel
- Pile incluse / Battery included
- Dim. 190 x 95 x 30 mm

### IN/OUT



**Ref. AR1800W**  
RÉVEIL ET THERMOMÈTRE INTÉRIEUR ET EXTÉRIEUR / ALARM CLOCK WITH IN/OUT TEMPERATURE

- Capteur étanche sans fil / Weather proof outdoor sensor
- Affichage LED bleu / Blue LED Display
- Face noire / Noir front panel
- Adaptateur secteur 220V / 220V AC adaptor
- Pile de sauvegarde incluse / Back-up battery included
- Dim. 240 x 55 x 25 mm

### OFF THE WALL



**Ref. T2000W**  
STATION MÉTÉO & RÉVEIL / WEATHER STATION & ALARM CLOCK

- Sonnerie avec prévisions pour 48h / 48h weather forecast
- Température intérieure et extérieure (capteur sans fil) / In & out temperature (Weather proof outdoor sensor)
- LCD Menu
- Size backlight display
- Positionnement mural ou bureau (si ind. amovible) / Wall or desk position
- Pile incluse / Battery included
- Dim. 145 x 137 x 18 mm

**Ref. AR1800W**  
RÉVEIL ET THERMOMÈTRE INTÉRIEUR / ALARM CLOCK WITH IN/OUT TEMPERATURE

- Capteur sans fil étanche / Weather proof outdoor sensor
- Calendrier / Calendar
- Positionnement mural ou bureau (si ind. amovible) / Wall or desk position
- Pile incluse / Battery included
- Dim. 240 x 55 x 25 mm

**Ref. AR1000**  
HORLOGE SOLAIRE SOLAR CLOCK

- ECO-energy / Energy saving system
- Affichage LCD géant / Large LCD display (from 10 minutes to seconds)
- Pile incluse / Battery included
- Dim. 280 x 140 x 35 mm

**Ref. AR1000R**  
HORLOGE RADIO / RADIO CONTROLLED CLOCK

- Réglage automatique de l'heure par onde radio / Automatic time setting
- Calendrier et température / Calendar & temperature
- Positionnement mural ou bureau (si ind. amovible) / Wall or desk position (if available)
- Face en verre teinté noir / Black glass front panel
- Pile incluse / Battery included
- Dim. 250 x 155 x 40 mm



# Addex

## CALCULATOR



**AC438**  
DESKTOP SOLAR CALCULATOR  
• Dual power  
• Extra slim  
• 10-digit display  
• Aluminum finishing  
• Dim. 95 x 175 x 10 mm  
⊗ 40 x 15 mm TA



**AC500**  
DESKTOP SOLAR CALCULATOR  
• Dual power  
• 10-digit display  
• Aluminum  
• Dim. 110 x 180 x 20 mm  
⊗ 40 x 15 mm TA



**AC470**  
DESKTOP SOLAR CALCULATOR  
• Dual power  
• 10-digit display  
• Dim. 110 x 190 x 7 mm  
⊗ 40 x 15 mm TA



**AC809**  
POCKET SOLAR CALCULATOR  
• Dual power  
• 10-digit display  
• Marble maze game  
• Dim. 60 x 120 x 12 mm  
⊗ 30 x 10 mm TA



**AC450**  
DESKTOP SOLAR CALCULATOR  
• Dual power  
• 10-digit display  
• Acrylic keys  
• Dim. 105 x 170 x 12 mm  
⊗ 90 x 20 mm TA



**AC400**  
POCKET SOLAR CALCULATOR  
• Dual power  
• 8-digit display  
• Rubber keys  
• Dim. 70 x 130 x 12 mm  
⊗ 30 x 12 mm TA



**AC401**  
POCKET SOLAR CALCULATOR  
• Dual power  
• 8-digit display  
• Rubber keys  
• Dim. 60 x 120 x 6 mm  
⊗ 30 x 12 mm TA



**AC420**  
DESKTOP SOLAR CALCULATOR  
• Dual power  
• 10-digit display  
• Acrylic keys  
• Dim. 105 x 190 x 40 mm  
⊗ 90 x 20 mm TA



**AC400**  
POCKET SOLAR CALCULATOR  
• Dual power  
• 8-digit display  
• Rubber keys  
• Dim. 70 x 130 x 12 mm  
⊗ 30 x 12 mm TA

**AC401**  
POCKET SOLAR CALCULATOR  
• Dual power  
• 8-digit display  
• Rubber keys  
• Dim. 60 x 120 x 6 mm  
⊗ 30 x 12 mm TA



# Addex

[www.addex.com](http://www.addex.com)

## HIGH TECH

### GOOD VIBES



**01/EA SP200 S - VIBI**  
HAUT-PARLEUR PAR VIBRATION SANS FIL WIRELESS SPEAKER

- Connexion Bluetooth
- Bluetooth connection
- Amplification par vibration
- Amplification by vibration
- Fonction main-libre
- Hands free function
- Puissance 3W / 3W power
- Colonne en métal / Metal casing
- Rechargeable par USB / USB powered
- Câble USB et Audio / USB & Audio cables
- Dim. 10 x 10 mm

**02/EA SP200 N - VIBI**  
HAUT-PARLEUR PAR VIBRATION SANS FIL WIRELESS SPEAKER

- Connexion Bluetooth et NFC
- Bluetooth and NFC connection
- Amplification par vibration
- Amplification by vibration
- Fonction main-libre / 3 membranes
- Hands free function / 3 membranes
- Puissance 3W / 3W power
- Colonne en métal / Metal casing
- Rechargeable par USB / USB powered
- Câble USB et Audio / USB & Audio cables
- Dim. 11 x 88 x 140 mm

### IN THE AIR



### HIGH TECH



### DOLCE



**Ref. AD8550W - B / DOLCE**  
RADIO FM/AM & HAUT-PARLEUR SANS FIL FM/AM RADIO & WIRELESS SPEAKER

- Tuner analogique
- Analog tuner
- Connexion Bluetooth et filaire (AUX)
- Bluetooth & wired connection (AUX)
- Alimentation piles (non incluses) et secteur
- Battery powered (not included) & AC powered
- Puissance 5.5W / 5.5W power
- Appareil intégré
- Built-in adapter
- Antenne télescopique
- Telescopic antenna
- Dim. 310 x 250 x 80 mm

### MINI ! MINI !

**Ref. HPB10W - N - S / MINI**  
HAUT-PARLEUR SANS FIL WIRELESS SPEAKER

- Connexion Bluetooth
- Bluetooth connection
- Fonction déclencheur 'selfie'
- Remote shutter function
- Fonction main-libre
- Hands free function
- Finition métal / Metal finitoin
- Puissance 3W / 3W power
- Rechargeable par USB / USB powered
- Câble USB/micro USB / USB/micro USB cable
- Dim. 32 x 38 mm

### MOOD



**Ref. AD99-N / N - S - W - B / MOOD**  
RADIO & HAUT-PARLEUR FM RADIO & SPEAKER

- Radio FM / FM radio
- Prise AUX - entrée audio 3.5mm
- AUX-line-IN jack for audio player connection (3.5 mm)
- Finition polycarbonate et silicone
- Transparent PC with rubber finishing
- Alimentation par piles (4xLR6 non incluses)
- Powered by 4 x LR6 (not included)
- Dim. 85 x 85 x 85 mm

### FITNESS



### WAKE UP!







# Beer O'Clock

## Hand Sanitizer



Our classic selection of typical European Beers has been adapted into a range of miniature bottles of **HAND SANITISER GELS**

A perfect gift for beer lovers, but without the smell!  
The Hand Gel Beer Selection is presented in a full colour box and includes:

- Shamrock Stout Gel
- Special Lager Gel
- Old Wobbler Bitter Gel

Hand sanitising or Manitising will never be the same!  
Made in the UK using 70% alcohol. Use responsibly!  
Manufactured in the UK.

Our specially formulated Beer O'Clock Hand Sanitiser Gel will dry quickly when applied and will leave hands feeling clean, soft and lightly scented.

# Doming Labels

GIVES ANY PRODUCT EXCLUSIVITY

## Personalisierung von Produkten leicht gemacht



- Farbbeständig
- UV – beständig
- Seewasserbeständig
- Säure- und Lösungsmittelbeständig
- Selbstklebend
- verschiedene Kleberstärken
- Langlebig
- Mercury Free - der erste in Europa

## ECO Range

**T'nB INTELLIGENT accessories**

# ECO RANGE

**T'nB is committed to reducing its carbon footprint with its eco-designed range**  
A product range consisting of 45% eco materials. These materials are plant polymers that replace part of the plastic that makes up the product.

We could have stayed there and be satisfied with that effort, but we chose to go further. The 55% are made of recycled plastic. We do not create plastic to make this charger which leads to a drastic reduction in the use of fossil materials.

The packaging of this charger is also environmentally friendly, it is made of cardboard and contains no plastic. Its compact design allows you to charge all your devices with a USB-A cable, no matter the connector, Micro USB, Mini USB, USB Type-C or Lightning. The USB-A port is compatible with the 12W fast charging, allowing you to recharge your devices very quickly.

**Eco-designed 1 USB 2.4A mains charger - CHUSB24ECO**  
Made from 45% eco-materials - PLA from corn - Packaging 100% cardboard 0% plastic - Compact - Fast charging of all your USB devices (tablets, smartphones, reader MP3 ...) - Input: 100-240V (AC) - 50Hz-60Hz - 0.4A - max - Output: 5V / 2.4A 12W max. - Color: sand

**ECO CHARGEUR UNIVERSAL**  
smartphones & tablets  
FAST CHARGING 12w  
MADE WITH ECO MATERIALS

**ECO CHARGEUR ALLUME-CIGARE UNIVERSAL**  
for smartphones & tablets  
FAST CHARGING 24w  
MADE WITH ECO MATERIALS

**ECO CABLE**  
Made for iPhone | iPad | iPod  
1.5m  
MADE WITH ECO MATERIALS



TOYS

# Imagicom

[www.imagicom.it](http://www.imagicom.it)

## REMOVABLE STICKERS – MINIONS

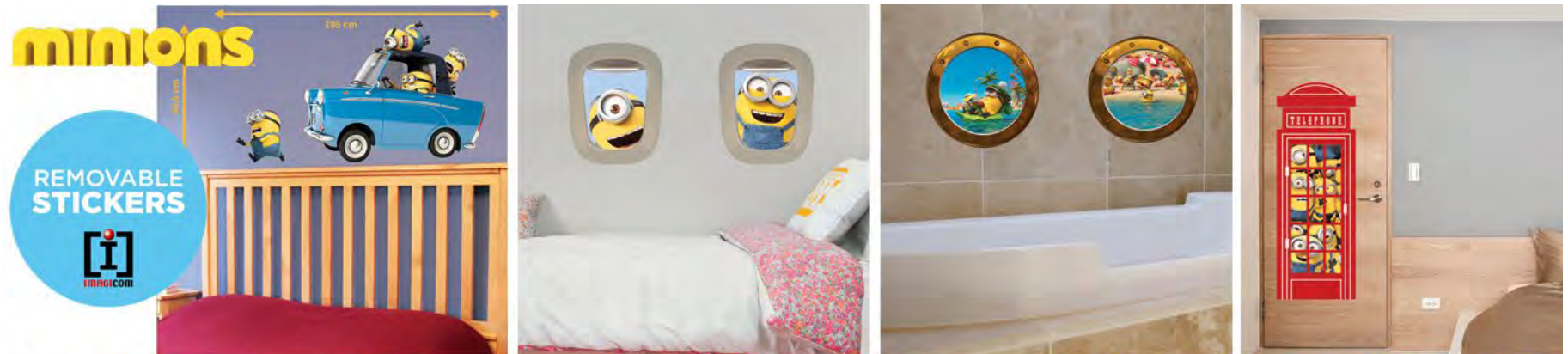

# Lexibook

[www.lexibook.com/](http://www.lexibook.com/)

## Schachcomputer



CG1335

Für Anfänger, Fortgeschrittene  
und Meisterschaftslevel!

ChessMan® – Elektronisches Schachspiel

CG1300



**AB 7 JAHRE**  
**1-2 SPIELER**  
**64 SCHWIERIGKEITSTUFEN**  
**ELO 1800 SYSTEM**

LCG3000



**AB 7 JAHRE**  
**1-2 SPIELER**  
**64 SCHWIERIGKEITSTUFEN**  
**ELO 1800 SYSTEM**

**AB**  
**7**  
**JAHRE**

## POWERMAN



**Der intelligente interaktive Roboter für Kinder von 4 bis 7!**

Lernen und Spielen mit Powerman, ein neuer Freund für Jungen und Mädchen!

Powerman ist ein komplett interaktives Spielzeug, das spricht und jede Menge Inhalt, Lichter und Geräuscheffekte bietet. Er kann Geschichten und Witze erzählen, lustige Rätsel aufgeben, Musik abspielen, mit den Kindern tanzen und besitzt noch viele andere coole Eigenschaften zum Entdecken!

Er wird mit einer Fernsteuerung geliefert und lässt sich kinderleicht nach Belieben steuern: vorwärts, rückwärts, nach links und rechts. Powerman kann in alle Richtungen gehen!

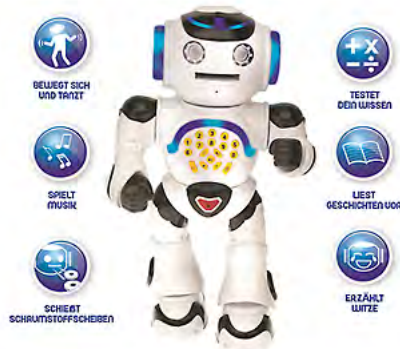

**Ich bin ein echter Freund zum Lernen!**

Powerman gibt auf lustige Weise Rätsel auf! Kinder werden mit Zahlen, dem täglichen Leben, Tieren, Wörtern und vielen anderen faszinierenden Themen vertraut gemacht.

- Wie viele Flügel hat eine Libelle?
- Wie viele Buchstaben hat das Wort „Pferd“?
- Was ergibt drei plus fünf minus sieben?
- Zwei Delfine, vier Haie und ein Wahl schwimmen im Meer.
- Wie viele Säugetiere schwimmen dann im Meer?



Zum Antworten muss das Kind nur die Tasten an seinem Körper drücken. Powerman sagt dann, ob es die richtige Antwort war ... oder nicht!



**Wir lernen Aesops Fabeln kennen!**

Powerman kann zehn der beliebtesten Geschichten erzählen, wie „Der Katze eine Schelle umhängen“, „Der Fuchs und die Trauben“, und „Der Löwe und die Maus“.

**Tanzt mit mir!**

Powerman bietet 12 Lieder und 2 Tanzchoreografien. Mit seinen zwei Lautsprechern und den tollen Lichteffekten, wird er alle zum Staunen bringen!

**Ich wiederhole, was ihr sagt!**

Wenn die Aufnahme- und Wiedergabetaste gedrückt wird, wiederholt Powerman alles, was gesagt wird in seiner lustigen Roboterstimme.

**Ich schieße mit Schaumstoffscheiben!**

Eine Lieblingsbeschäftigung von Powerman ist das Schießen von Schaumstoffscheiben. Einfach den Roboter in Position bringen und abfeuern! 9 Schaumstoffscheiben sind im Lieferumfang enthalten.

**Inhalt:**

- 1 Roboter
- 1 Fernsteuerung
- 1 Bedienungsanleitung
- 9 Schaumstoffscheiben

**Benötigt:** 5 x LR6/AA-Batterien für den Roboter (nicht inbegriffen)  
+ 2 x LR6/AA-Batterien für die Fernsteuerung (nicht inbegriffen).







# Lexibook

## THE VOICE KIDS



### Mini Bluetooth® tower with Microphone BTP155TVZ

- Operates wirelessly with your Bluetooth®-equipped devices!
- Aux in jack, USB and SD cards ports to listen to your music very easily!
- Speakers: 4W
- LED lights coming out from the 2 speakers!
- Handle on the top to carry anywhere and built-in rechargeable battery
- Mini USB to charge the speaker (cable included)
- Microphone included to sing on your favourite songs (with volume and echo control)
- Packaging Type: Closed box
- Power supply: Built-in & rechargeable lithium battery (1200mAh)



### The Voice Acoustic Guitar K2000TV

- Learn to play like a rock star!
- Size: approximately 31" long.
- Wood.
- 6 nylon cords.
- Mediator and guitar strap provided, for an optimal comfort and hours of music after class!
- Bonus feature! Includes a guide for learning how to play guitar!



### Bluetooth® Karaoke Mic The Voice MIC200TV

- An amazing Wireless Microphone with speaker integrated and colorful LED lights for parties you won't forget!
- Speaker integrated: 5Watts for high quality sound!
- High sensitivity microphone
- Record function: through Red Karaoke application!
- Light-up speaker with LEDs that flash with the music! Multicolours LEDs!
- Works with every Bluetooth® equipped device
- Micro SD/TF card slot to listen directly to your MP3 music
- Power supply: Rechargeable Lithium Battery



### The Voice Bluetooth® Portable Speaker with lights K920TV

- Bring your music anywhere and get ready for the Voice stage!
  - Powerful 10W output power speaker with lighting effects!
  - Operates with any Bluetooth® equipped devices
  - 3.5mm AUX-in input
  - Supports USB for audio input and micro SD/TF card
  - 2 x 6.3mm microphone or musical instrument inputs with ECHO adj.
  - Rechargeable battery
- Includes:
- 1 Bluetooth® Speaker (Product dimensions: 15.5\*19.3\*12.3 cm)
  - 1 microphone
  - Packaging type: Closed Box
  - Power supply: Rechargeable battery



### The Voice „Keytar“ K280TV

- Let's groove with this unique The Voice "Keytar"!
- Select the instrument you want to play between Piano, Organ, and two different Electric guitar tones!
- 8 music patterns available to play on: Swing, Waltz, Rock, Disco, Twist, Blues, 16 beat pop & Beat mode
- Use the vibrato trigger to sustain the note or create a vibrato sound effect while playing, or to play a guitar solo!
- Size: approximately 21" long (54 cm) and 7" large (18 cm)
- Bonus feature: A strap is included to carry it comfortably while playing!
- Power supply: 3 x AA/LR6 (Included)



# Lexibook

## TOYS



# Lexibook

## TOYS





# Mini Hornit

## THE WILD BICYCLE HORN



### DAS WELTWEIT WILDESTE FAHRRADHORN

- LED-Sicherheitslicht in weiß und grün
- 25 spaßige Sounds wie z.B. Feuerwehr, Formel 1, Flugzeug, Pferd ...
- zusätzlicher Daumenauslöser am Lenker (Hände müssen beim Betätigen somit nicht vom Lenker genommen werden)
- mit speziellen Flügel-Clips im Handumdrehen an- & abmontiert
- passend für jedes Rad und jeden Roller
- IP33 (wassergeschützt), 2 Jahre Garantie

MIT LED-LICHT & 25 TOLLEN SOUND-EFFEKTEN!



The Mini Hornit, schwarz / gelb



The Mini Hornit, blau / orange



The Mini Hornit, lila / pink



The Mini Hornit, rot / blau



# Particula

[www.particula-tech.com](http://www.particula-tech.com)

## The Rubik's World

- Connected Cube



## The Rubik's World

- The Best Selling toy in History!
- Over 500M units sold worldwide.
- Yearly sales of 40M original cubes!

The future of this world is the GoCube!



### Awards & Recognitions

- A digital version of the best selling toy in history!
- Parents' Choice Award 2020
- "Best Tech Gifts 2019" - WSJ
- "Best STEM Toys" - WIRED
- "Best Brain-Building Puzzles" - Fatherly
- Thousands of 5 stars raving reviews ★★★★★
- Sold on: Apple.com



### GoCube



GoCube-X



GoCube-2X2



Rubiks Connected

## Educational Features

- Problem Solving - Learn the fundamentals of computational thinking
- 3D Spatial Awareness - Develop cognitive skills and sense of space
- Build self-esteem and confidence, as well as personal achievement and determination
- Social Skills - Play & Compete
- Memorization - Through memorizing patterns and algorithms
- Hand and Eye Coordination



# Particula

[www.particula-tech.com](http://www.particula-tech.com)

## GoDice

### Lots of Games

- ▶ Yatzy
- ▶ Farkle
- ▶ Ludo
- ▶ Funny Bugs
- ▶ Shut the Pool
- ▶ Pig
- ▶ Unlucky Seven
- ▶ Backgammon
- ▶ Ship Captain Crew
- ▶ Tawia 31
- ▶ Trivia-Coming Soon
- ▶ Bomb Squad
- ▶ Red Goes Off
- ▶ GoPRG-Dice calculator for Dungeons & Dragons



Board Games, COME TO LIFE!  
Fits all ages and capabilities

Play together    Fun & Educational!    Added value to screen time    Compact, light, durable    60+ hours play time

**GoDice**  
Incredibly Smart Connected Dice

Discover a whole new way to play your favorite board games. Get instant access to 10+ of our most popular dice games, reimagined and reinvented!

Download on the App Store    Get it on Google play

**GoDice**  
dice

**GoDice**  
dice

**Dice Games of the 21st Century**

**10sec charging**  
2hours playtime

# Powerplus

[www.powerplus.nl](http://www.powerplus.nl)

## ENERGY SAVING TOYS

 <p><b>AIR CAR</b> Air Pressure Powered Toy Car</p> <p>Power generation: Air Pressure Size: 23 x 16 x 17 cm Weight: 200 gr EAN: 8717853704024</p> 	 <p><b>MUSTANG</b> Dynamo Generator Racetrack Toy</p> <p>Power generation: Dynamo Weight: 1.800 gr EAN: 8717853702260</p>	 <p><b>SCORPION</b> 3 in 1 Toy Set</p> <p>Power generation: Solar Size: 20 x 17.5 x 4 cm Weight: 78 gr EAN: 8717853702051</p> 
<p><b>BOBCAT</b> Salt Water Powered Buggy Car</p> <p>Power generation: Salt Water Size: 12 x 9 x 5 cm Weight: 40 gr EAN: 8717853704335</p>  	<p><b>MOONWALKER</b> Solar 6-Wheel Vehicle</p> <p>Power generation: Solar Size: 10 x 8 x 8 cm Weight: 65 gr EAN: 8717853704659</p>  	<p><b>SOLAR RECYCLER</b> 6 in 1 Recycle Toy Set</p> <p>Power generation: Solar Size: 25.6 x 17 x 5 cm Weight: 170 gr EAN: 8717853703423</p>  
 <p><b>BUTTERFLY</b> 6 in 1 Hybrid Power Toy Set</p> <p>Power generation: Solar Battery: Capacitor Size: 21 x 19 x 5.6 cm Weight: 156 gr EAN: 8717853702617</p> 	 <p><b>OCTOPUS</b> Hydraulic Robot Arm Toy</p> <p>Power generation: Water hydraulic Size: 30 x 26 x 33 cm Weight: 650 gr EAN: 8717853704345</p> 	 <p><b>SPACE EXPLORER</b> 7 in 1 Hybrid Power Toy Set</p> <p>Power generation: Solar Size: 21 x 19 x 5.5 cm Weight: 168 gr EAN: 8717853703003</p> 
<p><b>CHAMELEON</b> 6 in 1 Toy Set</p> <p>Power generation: Solar Size: 20 x 17.5 x 4 cm Weight: 76gr EAN: 8717853701443</p>  	<p><b>ROBIT</b> 14 in 1 Toy Set</p> <p>Power generation: Solar Size: 20 x 17.5 x 4 cm Weight: 292 gr EAN: 8717853702877</p>  	<p><b>THUNDERBIRD</b> Monster 4 Wheel Drive Car Toy</p> <p>Power generation: Salt Water Size: 21 x 16 x 5.5 cm Weight: 186 gr EAN: 8717853702556</p>  



# Science and Nature

[www.scienceandnature.com.au](http://www.scienceandnature.com.au)

## WOODEN PATHFINDERS RANGE



# Slimy

## ORIGINAL SLIMY-CLASSIC HQ PLAY MASS FOR KIDS



Die Original SLIMY® Spielmassen basieren auf natürlichen Inhaltsstoffen und werden nach einem einzigartig neuen, patentierten Konservierungsverfahren für maximale Hautverträglichkeit OHNE Parabene und zu 100% glutenfrei hergestellt, wobei alle Formulierungen sowie die Rohmaterialien zur Sicherung der Qualität aus der Schweiz kommen.



# Slimy

## ORIGINAL SLIMY-CLASSIC HQ PLAY MASS FOR KIDS



### THE ORIGINAL SMILEY BRAND TOP LIZENZ-NEUHEIT!

NEU!

SMILEY SLIMY – das Original SLIMY® im Original SMILEY®-Design von SmileyWorld®!

Lustige SMILEY SLIMY-Freunde für Jung und Alt zum Sammeln und für glitschig-klebrigen Spielspaß! EXPRESS YOURSELF! Die attraktiven SMILEY SLIMY-Dosen können auch als praktische Behälter zur Aufbewahrung von kleineren Gegenständen verwendet werden (z.B. Münzen, Schmuck, Glasperlen, etc.).

Die Original Slimy Spiel- und Knetmassen werden nach strengsten Qualitätskriterien auf Basis natürlicher Inhaltsstoffe ohne Parabene und zu 100 % glutenfrei hergestellt! Garantiert sicherer Spielspaß für Kinder und jung Gebliebene!



SMILEY SLIMY / 18 Stk. im Thekendisplay sortiert  
Füllgewicht: Dose 170 g

Art.-Nr. 33435 Stück/VE: 18



- Trocknet nie aus
- Einzigartige Material- und Farbeffekte
- Weich wie Wachs oder hart wie Glas
- Hüpf wie ein Ball oder zerrinnt wie Lava
- Wechselt die Farbe oder leuchtet im Dunkeln
- Unendlicher Spaß mit den geheimnisvollen Elementen des Universums
- Fördert Konzentration und Vorstellungsvermögen



Knete Genius „Anti-Materie“-Serie  
75 g Dosen im Blister / 4 Farben sortiert

Art.-Nr. 33981 Stück/VE: 12



Knete Genius „Metallic“-Serie  
75 g Dosen im Blister / 5 Farben sortiert

Art.-Nr. 33984 Stück/VE: 12

Smiley, names, characters and all related indicia are owned by The Smiley Company ©1971 - 2017. All rights reserved.



1. Auspacken
2. Weichheit testen
3. Kneten und Formen
4. Formen nach Bedarf
5. Kneten und Formen
6. Weichheit testen
7. Kneten und Formen
8. Kneten und Formen

- KNETE Genius
- Melt it
  - Bounce it
  - Snap it
  - Anti-stress
  - Form it into whatever you want
  - Print with it
  - Stretch it and pull it

# Thimble Toys

[www.thimbletoys.com](http://www.thimbletoys.com)

The 4th Dimension: a perfect and unique game to give

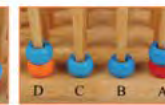
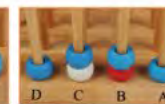
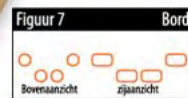
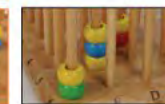
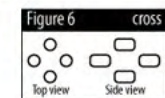
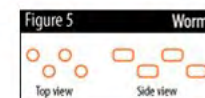
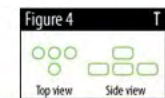
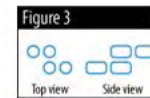
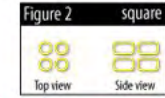
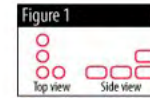

MISCELLANEOUS

## Oil Radiators

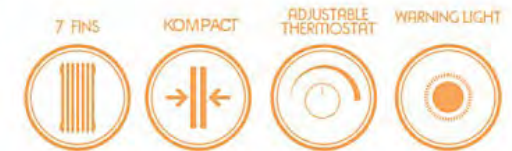
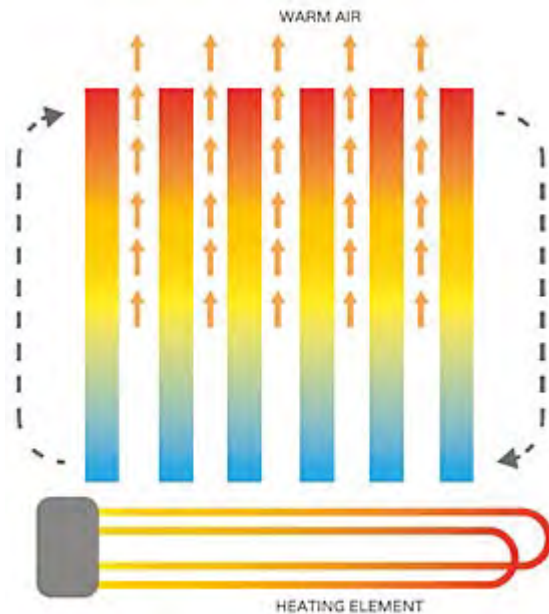

Radiator with 7 fins, 100x335mm with 3 oil circulation channels: it heats by natural convection

- Adjustable room thermostat with OFF position
- Tipover switch
- Signal lamp
- Handle integrated in the control panel
- Metal structure
- IP20 degree of protection
- Suitable for approximately 6m<sup>2</sup> rooms.



Oil filled radiator with 9 elements 125x575mm, and 5 oil circulation channels: it heats by natural convection

- Selector: 0/ Eco (1000W)/ Comfort (1500W)/ Rapid (2500W)
- Adjustable room thermostat
- Tip-over switch
- Signal lamp
- Supports with pivoting castors
- Integrated handle
- Metal structure
- IP20 degree of protection
- Suitable for approximately 25m<sup>2</sup> rooms

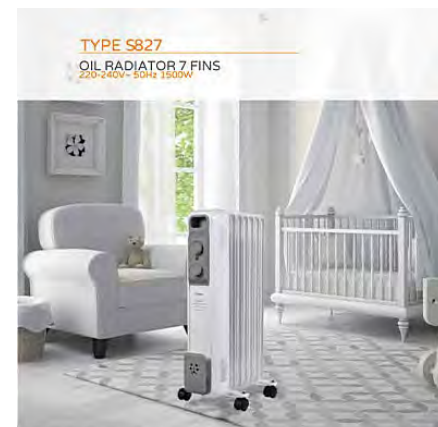

Radiator with 7 elements 125x575mm, and 5 oil circulation channels: it heats by natural convection

- Selector: 0/ Eco (600W)/ Comfort (900W), Rapid (1500W)
- Adjustable room thermostat
- Tip-over switch
- Signal lamp
- Supports with pivoting castors
- Integrated handle
- Metal structure
- IP20 degree of protection
- Suitable for approximately 15m<sup>2</sup> rooms

# Carbon8

[www.carbon8water.com](http://www.carbon8water.com)

## Sparkling Water & Lunch Box



# Easy Wrapper®

Special Cloth by Next Generation Hook & Loop Fastener Technology



**EASY WRAPPER®** is a wrapping cloth for the new era, which protects the contents without tapes, buttons, bands etc.

**7 colors 4 sizes** Back : Gray / Material : 100% Polyester

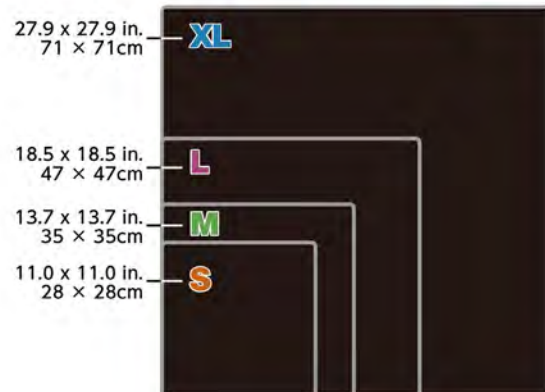

### Structure of general hook and loop fastener

Two faces stick to each other by hooking with loops. As prominent part will be worn away by time, the sticking strength on each side becomes weaker and weaker as time passes by.



### Structure of EASY WRAPPER®

Hook side(A) and Loop side(B) don't get tangled to each faces and just stick firmly with a semipermanent grip.

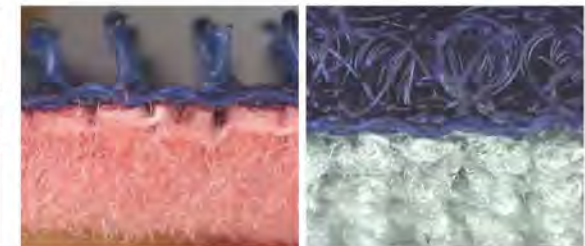

Blue : Hook of Velcro  
Pink : Fiber of EASY WRAPPER®

Blue : Loop of Velcro  
White : Loop of EASY WRAPPER®



# Glowstone

[www.glowstone.tech](http://www.glowstone.tech)

## Self heating smart mug

- Charges wirelessly
- Lightweight
- Lightbar indicates Temperature



**THE SELF-HEATING SMART MUG**

**CREATED TO PERFECTION**  
All the materials used, the shape of the drinking cavity, the ease of use and cleaning, every single detail has been considered and refined.

**RELIABLE DESIGN**  
Drinks are kept at the optimum drinking temperature of 140°F (60°C) to 150°F (65°C).

**ELEGANT FINE BONE CHINA**  
Enhancing the taste of drinks alongside looking and feeling beautiful.

**WIRELESSLY POWERED**  
Qi charging coaster to effortlessly charge the Smart Mug.

**FINE BONE CHINA OPTIMISES TASTE**

**LIGHTWEIGHT YET ROBUST DESIGN**

**LIGHTBAR INDICATES DRINK IS IDEAL TEMPERATURE**

**YOUR DRINK HOT TO THE LAST DROP**

**BASE COOL EVEN DURING HEAT CYCLE**

**FULLY AUTOMATIC**

**WORKS STRAIGHT OUT THE BOX**

**HANDLE ERGONOMICALLY DESIGNED**

**CHARGES WIRELESSLY WITH QI COASTER**



**HONEYCOMB MUG**  
Power and elegance refined



**CLASSIC MUG**  
Effortlessly simple  
Available in White, Pink, Stone & Blue

# Imagicom

[www.imagicom.it](http://www.imagicom.it)

## REMOVABLE STICKERS

<p><b>LEGENDARY GUITAR</b> Size: cm 50x70 (1 sheet) - Code: WALLSTK115</p>	<p><b>REMOVABLE STICKERS</b></p>	<p><b>DISPENSER + SHOES</b> Size: A3 (2 sheets) - Code: WALLSTK203</p>	<p><b>REMOVABLE STICKERS</b></p>	<p><b>MINI</b> Size: cm 50x70 (2 sheets) - Code: WALLSTK119</p>	<p><b>REMOVABLE STICKERS</b></p>
<p><b>ITALIAN SCOOTER</b> Size: cm 50x70 (1 sheet) - Code: WALLSTK117</p>	<p><b>REMOVABLE STICKERS</b></p>	<p><b>VALVE + PHONE</b> Size: A3 (2 sheets) - Code: WALLSTK201</p>	<p><b>REMOVABLE STICKERS</b></p>	<p><b>FACES ICONS</b> Size: A3 (4 sheets) - Code: WALLDEC208</p>	<p><b>REMOVABLE STICKERS</b></p>

# Imagicom

[www.imagicom.it](http://www.imagicom.it)

## REMOVABLE STICKERS

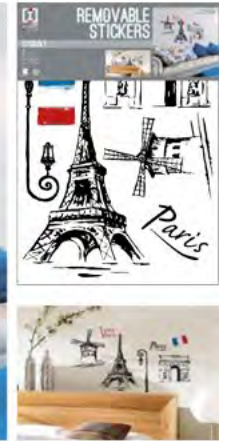
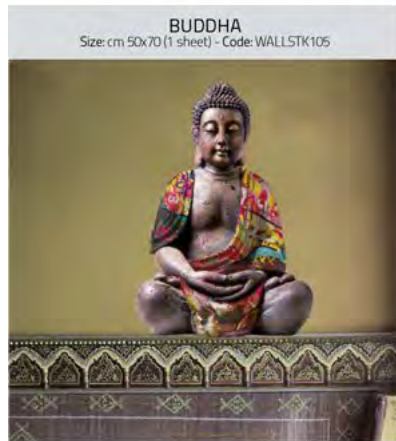

# Imagicom

[www.imagicom.it](http://www.imagicom.it)

## REMOVABLE STICKERS



# Imagicom

## REMOVABLE STICKERS

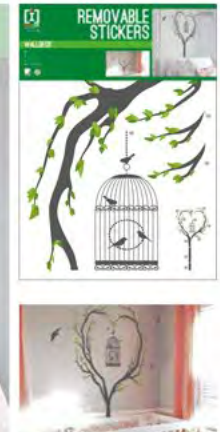
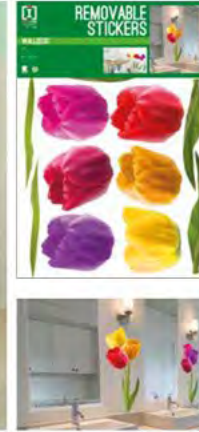
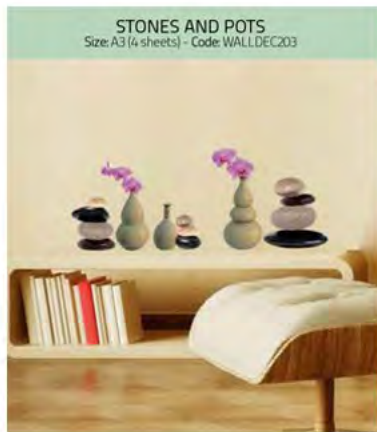

# Imagicom

[www.imagicom.it](http://www.imagicom.it)

## CALENDAR

The collage features the following calendar covers:

- FC BARCELONA** (Official Calendar 2017)
- Real Madrid** (Third Party Calendar, Official Images Not Available Yet)
- BASKET STARS** (Calendar 2017)
- GRAND PRIX** (Calendar 2017)
- MOTORBIKE GRAND PRIX** (Calendar 2017)
- ELVIS** (Official Calendar 2017)
- Minions** (2017 Official Calendar)
- DORY** (2017 Official Calendar)
- STAR WARS** (Stormtrooper helmet)
- Jimi Hendrix** (Official Calendar 2017)
- RANDO FACES** (2017)
- NEW YORK** (Calendar 2017)
- Funny Pets** (calendar 2017)
- ARIANA GRANDE** (Official 2017 Calendar)
- JUSTIN BIEBER** (Official 2017 Calendar)
- MORRISON** (Official Calendar 2017)
- Audrey** (Official Calendar 2017)
- MARILYN** (Official Calendar 2017)
- Hot Chicks** (Calendar 2017)
- Banks** (Calendar 2017)
- JOHNNY DEPP** (Official Calendar 2017)
- CAPTAIN AMERICA: CIVIL WAR** (2017)
- THE FAB 4** (Official Calendar 2017)
- Hot Chicks** (Another view of the calendar)
- THE BEATLES** (Another view of the calendar)

**Display Options:**

- DISPLAY A:** 12 pockets with spinner. For 100 units. \$2 per square.
- DISPLAY B:** 24 units. \$2 per square. Ideal as counter top display.
- DISPLAY C:** 20 units. \$2 per square. Ideal as counter top display.
- DISPLAY D:** 75 units. \$2 per square. Ideal as floor display.
- DISPLAY E:** 45 units. \$2 per square. Ideal as floor display.

## BAMBOO IN THE KITCHEN



111123  
43,5x43,5x39cm

124570  
55x20x21cm

114471  
51x30x80cm

155958  
78x32x45,5cm



125130A  
38x28x2cm

125131  
59,5x15,5x2cm

124514A  
45x19,7x1,2cm

134514  
35x25x1,2cm

540724263  
37x28cm



100162  
29x85cm

100163  
36x35x110cm

155955  
35x32x77,5cm

155956  
35x32x111,5cm

216716021  
28x16x88cm

540724233  
27x12,5x61cm



111530  
13,2x8,2x27cm  
KITCHEN TOOLS HOLDER

111534  
26x20x7,3cm  
CHEESE BOX + LID

111635  
36x11x9,5cm  
5 COMPART BOX

151154  
21,9x15,7x8,7cm  
TEA BOX X6 COMPART

151259  
38x14,9x14cm  
CAPSULE DRAWER



103601  
39x27,2x15cm  
BREAD BOX INOX+PS

111534  
34x25x4,2cm  
CUTLERY HOLDER

120056  
42x33,2x25cm  
DRAINING BOARD

120058  
30x6x0,8cm  
4 PCS KITCHEN WARE SET

120059  
16x13,5x5cm  
PESTLE

140751  
16x22x6cm  
WHITE MIRROR

150734  
23x9,5x9cm  
ORGANIZER

151180  
20,6x10x20,7cm  
CUTLERY HOLDER

160397  
35,5x13,5x14,5cm  
STORAGE POCKETS PEG

151185  
38x14,9x14cm  
SLIDING ORGANIZER TS X3

# Platinet

## OUTDOOR HEATER

### Economical Infrared Heating



#### TECHNICAL SPECIFICATION PTHCL

IR Sensing Table Heater  
Triple IR Sensors  
Auto Turn-on When People Get Close  
Auto Shut-off When People Get Away  
IR Sensing Feature On/Off Optional  
Anodized Extruded Aluminium Alloy Frame  
High Efficiency Carbon Fibre Heating Element  
Power: 1200W  
1.8 Metres Power Supply Cord  
Tempered Glass Table Top: Ø=50cm  
Stainless Steel Base Cover: Ø=40cm  
Height: 65cm  
LED Lighting  
360 Degree Tip-over Safety Switch  
Ip44 Approved



#### TECHNICAL SPECIFICATION PTHRC75

IR Remote Control Table Heater  
Anodized Extruded Aluminium Alloy Frame & Control Box  
High Efficiency Carbon Fibre Heating Elements  
Two Power Settings: 800W, 1600W  
1.8 Metres Power Supply Cord  
Tempered Glass Table Top: Ø=80cm  
Stainless Steel Base Cover: Ø=50cm  
Height: 75cm  
360 Degree Tip-over Safety Switch  
IP55 Approved



#### TECHNICAL SPECIFICATION PTHRC110

Bar Table Heater with Remote Control  
Anodized Extruded Aluminium Alloy Frame & Control Box  
High Efficiency Carbon Fibre Heating Elements  
Two Power Settings: 800W, 1600W  
1.8 Metres Power Supply Cord  
Tempered Glass Table Top: Ø=60cm  
Stainless Steel Base Cover: Ø=50cm  
Height: 110cm  
360 Degree Tip-over Safety Switch  
IP55 Approved  
With Foot Bracket and Wheels



# Platinet

[www.platinet.eu](http://www.platinet.eu)

## SMART GARDEN



### Fresh Fruit and Vegetables Always in Your Kitchen

You don't need to have your own garden to enjoy vegetables and fruits. What's more - now you can create garden in your own kitchen!



- Dill
- Basil
- Chives
- Parsley
- Lettuce
- Arugula
- Oregano
- Chili Pepper
- Pepper Mint
- Wild Strawberry

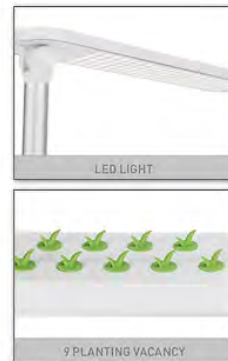

### SAVE YOUR TIME

Prepare the seeds, place them in a special box with a sponge until germination. Later, they should be replanted to the Smart Garden and filled in with the nutrients in the container. After 14 days, the planted fruits or vegetables are fully ripe.



**After transplantation**  
Make sure roots are in contact with the water.



**After 7 days**  
As the plants grow make sure the proper amount of nutrient water remains in the box.



**After 14 days**  
You'll have fully matured fruits and vegetables! Harvest and enjoy!



# Promate

## MISCELLANEOUS

<p>             Motion Sensor              Auto Power on              100m LED Lights              2000 mAh Battery              Water Resistant              Light Sensor              180 Motion Sensor              8 LED Modes         </p>	<p>             Dual Motion Sensor              Solar Powered              2000 mAh Battery              Water Resistant              Light Sensor              120 Motion Sensor              10 Hours Usage Time         </p>	<p>             Motion Sensor              Auto Power on              100m LED Lights              2000 mAh Battery              Water Resistant              Light Sensor              180 Motion Sensor              8 LED Modes         </p>	<p>             Motion Sensor              Auto Power on              100m LED Lights              2000 mAh Battery              Water Resistant              Light Sensor              180 Motion Sensor              8 LED Modes         </p>	<p>             Motion Sensor              Auto Power on              100m LED Lights              2000 mAh Battery              Water Resistant              Light Sensor              180 Motion Sensor              8 LED Modes         </p>	<p>             Motion Sensor              Auto Power on              100m LED Lights              2000 mAh Battery              Water Resistant              Light Sensor              180 Motion Sensor              8 LED Modes         </p>
<p>             Motion Sensor              Auto Power on              100m LED Lights              2000 mAh Battery              Water Resistant              Light Sensor              180 Motion Sensor              8 LED Modes         </p>	<p>             Touch Sensor              Night Light              ENERGY EFFICIENT              3 LED Modes         </p>	<p>             Touch Sensor              Night Light              ENERGY EFFICIENT              3 LED Modes         </p>	<p>             Touch Sensor              Night Light              ENERGY EFFICIENT              3 LED Modes         </p>	<p>             Touch Sensor              Night Light              ENERGY EFFICIENT              3 LED Modes         </p>	<p>             Bluetooth v4.0 Speaker              5 LED Modes              4-6 Hours Usage Time              10000mAh Powerbank              3 in 1         </p>
<p>             IP54              6000mAh LED Light              3 LED Modes              LED Light              Safe &amp; Reliable              SOS Signal Function              5400mAh Powerbank         </p>	<p>             IP54              6000mAh LED Light              3 LED Modes              LED Light              Safe &amp; Reliable              SOS Signal Function              5400mAh Powerbank         </p>	<p>             Tire Inflator              Built-in TPMS              2500mAh              Built-in Powerbank              Heavy Duty              LED Light              USB Charging Port         </p>	<p>             TRAVELLERS CHOICE              EXPERIENCE THE DIFFERENCE              9 in 1              *tool kit              Emergency Glass Breaker              LED Torch              Digital Display         </p>	<p>             TRAVELLERS CHOICE              EXPERIENCE THE DIFFERENCE              9 in 1              *tool kit              Emergency Glass Breaker              LED Torch              Digital Display         </p>	<p>             Laptop Storage 18"              Adjustable Strap              Easy Carry Handle         </p>
<p>             Plug &amp; Play              USB-A Support              Micro-USB Support              SD &amp; Micro-SD Compatible              USB-C Connector              3.0 SUPER BI-FAST         </p>	<p>             Plug &amp; Play              USB-A Support              Micro-USB Support              SD &amp; Micro-SD Compatible              USB-C Connector              3.0 SUPER BI-FAST         </p>	<p>             Plug &amp; Play              USB-A Support              Micro-USB Support              SD &amp; Micro-SD Compatible              USB-C Connector              3.0 SUPER BI-FAST         </p>	<p>             Power Adapter Included              UK EU AU              15.5cm         </p>	<p>             Laptop Storage 15.6"              Adjustable Strap              Easy Carry Handle         </p>	<p>             Laptop Storage 15.6"              Adjustable Strap              Easy Carry Handle         </p>

# Trevi

[www.trevi.it](http://www.trevi.it)

## FOOD PREPARATION & HOME CARE



# Trevi

## FOOD PREPARATION



# Trevi

## FOOD PREPARATION

Resistenza Alpacma Griglia Acciaio INOX

1300 watt

12 Litri

Conforme a EN60335-2-6/A13:2010 grazie al costruttore di sicurezza

ESTENDI IL VOLUME DEL TUO FORNO CON L'ACCESSORIO OPZIONALE ANELLO 18 LITRI

18 Litri

0.263 - Caratteristiche di funzionamento

1500 watt

23 Litri

Grande capacità 4.5 litri

4.5 litri volume

1500 watt

1L

20 Litri

2000 watt

4.4

SCONGELAMENTO, RISCALDAMENTO E PROLUNGAMENTO COTTURA

Vaporetti - Steam cooker

Mantiene tutti i sali minerali e le proprietà organolettiche del cibo

LA COTTURA A VAPORE È SANA E NATURALE

1 2 3

1800 watt

900 watt

Il disco pronto in 4 minuti  
Il disco ready in 4 minuti

Quick plastic  
Waffle cooking area

1L  
sabatini

# Wacaco

## MINI ESPRESSO MACHINE



**WACACO**

